



**MSFC-HDBK-2221**  
**February 1994**

**National Aeronautics and  
Space Administration**

---

**George C. Marshall Space Flight Center**  
**Marshall Space Flight Center, Alabama 35812**

# **Verification Handbook**

## **Volume II: Verification Documentation Examples**

Verification Handbook  
Volume II: Verification Documentation Examples  
MFSC-HDBK-2221

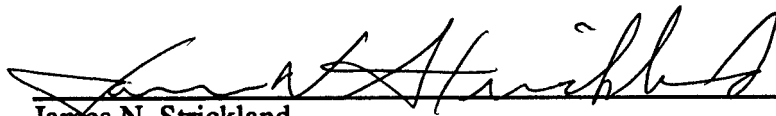

---

James N. Strickland  
Director, Systems Analysis  
and Integration Laboratory

8/22/94  
Date

TABLE OF CONTENTS

	<u>Page</u>
1.0 INTRODUCTION.....	1.0-1
1.1 Purpose.....	1.0-1
1.2 Handbook Organization.....	1.0-1
2.0 VERIFICATION DOCUMENTATION EXAMPLES.....	2.0-1
2.1 VERIFICATION REQUIREMENTS MATRIX.....	2.1-1
2.1.1 Introduction.....	2.1-2
2.1.2 Verification Requirements Matrix Example 1.....	2.1-3
2.1.3 Verification Requirements Matrix Example 2.....	2.1-65
2.2 VERIFICATION PLAN.....	2.2-1
2.2.1 Introduction.....	2.2-2
2.2.2 Verification Plan Example.....	2.2-3
2.3 VERIFICATION REQUIREMENTS AND SPECIFICATIONS DOCUMENT.....	2.3-1
2.3.1 Introduction.....	2.3-2
2.3.2 Verification Requirements and Specifications Document Example 1.....	2.3-3
2.3.3 Verification Requirements and Specifications Document Example 2.....	2.3-63
2.4 VERIFICATION REQUIREMENTS COMPLIANCE DOCUMENT.....	2.4-1
2.4.1 Introduction.....	2.4-2
2.4.2 Verification Requirements Compliance Document Example.....	2.4-3
2.5 INTEGRATED PAYLOAD VERIFICATION PLAN.....	2.5-1
2.5.1 Introduction.....	2.5-2
2.5.2 Integrated Payload Verification Plan Example.....	2.5-3
2.6 OPERATIONS AND MAINTENANCE REQUIREMENTS AND SPECIFICATIONS DOCUMENT.....	2.6-1
2.6.1 Introduction.....	2.6-2
2.6.2 Operations and Maintenance Requirements and Specifications Document Example.....	2.6-3

## **1.0 INTRODUCTION**

Verification documentation is considered by this handbook to be that documentation that is required to document verification planning, verification requirements, and verification requirements compliance information. The examples provided in the handbook are intended to show the type of information generally required in each document and the detail necessary to describe verification activities or to define verification requirements. The information presented by the examples is not intended to describe activities or to define requirements applicable to a particular project, even though most of the information is material that has been utilized or will be utilized by MSFC projects. Much of the documentation presented in this handbook has been modified to provide more complete examples.

### **1.1 Purpose**

The purpose of this volume is to provide examples of verification documentation as specified in Volume I of this handbook that can be used as a guide in the development of or in the assessment of similar documentation.

### **1.2 Handbook Organization**

This handbook is divided into two volumes. Volume I, Verification Process, defines a verification process and variations to the process. Volume II, Verification Documentation Examples, provides examples of the documentation that are generally required as products of a verification program.

Volume II is subdivided into six sections, each of which consists of examples of documentation for six verification activities: (1) Verification Requirements Matrix (VRM), (2) Verification Plan, (3) Verification Requirements and Specifications Document (VRSD), (4) Verification Requirements Compliance Document, (5) Integrated Payload Verification Plan (IPL), and (6) Operations and Maintenance Requirements and Specifications Document (OMRSD).

**THIS PAGE INTENTIONALLY LEFT BLANK**

## **2.0**

# **VERIFICATION DOCUMENTATION EXAMPLES**

**THIS PAGE INTENTIONALLY LEFT BLANK**

## **2.1**

# **VERIFICATION REQUIREMENTS MATRIX**



## **2.1.1 INTRODUCTION**

The Verification Requirements Matrix (VRM) defines how each requirement of a program requirements document is to be verified and the phase of the verification program when the verification activity is to occur. The VRM examples present the two formats generally used for defining verification methods. Example 1 provides the format generally used for small payload programs that would provide limited program design and performance requirements. Example 2 provides more detail in defining the verification methods and repeats the requirements in the VRM to allow all information related to the requirement to be readily visible. Both examples provide visibility of verification methods and phases as they relate to a particular type requirement.

Example 1 is the Configuration End Item (CEI) Specification with the Verification Requirements Matrix for the Solar X-Ray Imager (SXI) Program. Example 2 is the Verification Requirements Matrix for the Systems Requirements Document (SRD) of the National Launch System Program. Both examples were developed within the Science and Engineering Directorate of MSFC.

## **2.1.2**

# **VERIFICATION REQUIREMENTS MATRIX**

## **EXAMPLE 1**

**THIS PAGE INTENTIONALLY LEFT BLANK**

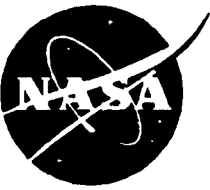

National Aeronautics and  
Space Administration

MSFC-HDBK-2221  
February 1994

---

George C Marshall Space Flight Center  
Marshall Space Flight Center, Alabama 35812

**SOLAR X-RAY IMAGER  
CONFIGURATION AND ITEM SPECIFICATION  
PART I**

**EXAMPLE**

**EXAMPLE**

THIS PAGE INTENTIONALLY LEFT BLANK

TABLE OF CONTENTS

SIGNATURE SHEET.....	N/A
DOCUMENT CHANGE RECORD.....	N/A
TABLE OF CONTENTS.....	2.1-7
LIST OF FIGURES.....	2.1-9
LIST OF TABLES.....	2.1-10
LIST OF ACRONYMS AND ABBREVIATIONS.....	2.1-11
1.0 INTRODUCTION.....	2.1-12
1.1 SCOPE.....	2.1-12
1.2 OBJECTIVE.....	2.1-12
2.0 DOCUMENTATION.....	2.1-12
2.1 APPLICABLE DOCUMENTS.....	2.1-12
2.1.1 Marshall Space Flight Center Documents.....	2.1-12
2.1.2 Goddard Space Flight Center Documents.....	2.1-13
2.1.3 Space Systems / Loral Documents.....	2.1-13
2.1.4 Other Documents.....	2.1-13
2.2 REFERENCE DOCUMENTS.....	2.1-14
3.0 REQUIREMENTS.....	2.1-15
3.1 GENERAL REQUIREMENTS.....	2.1-15
3.2 OPERATIONS REQUIREMENTS.....	2.1-19
3.3 PERFORMANCE REQUIREMENTS.....	2.1-19
3.3.1 Image Bandwidth.....	2.1-19
3.3.2 Spectral Sensitivity.....	2.1-19
3.3.3 Response to Charged Particles.....	2.1-20
3.4 MIRROR ASSEMBLY REQUIREMENTS.....	2.1-20
3.4.1 Encircled Energy.....	2.1-20
3.4.2 Effective Area.....	2.1-20
3.4.3 Focal Distance.....	2.1-20
3.4.4 Alignment Reference.....	2.1-20
3.4.5 Off Axis Mirror Resolution.....	2.1-21
3.4.6 Mirror Geometry.....	2.1-21
3.4.7 Mirror Mass.....	2.1-21
3.4.8 Resonant Frequency.....	2.1-21
3.4.9 Optical Axis Location.....	2.1-21
3.5 OPTICAL BENCH ASSEMBLY REQUIREMENTS.....	2.1-21
3.6 APERTURE PLATE ASSEMBLY REQUIREMENTS.....	2.1-21
3.7 FILTER WHEEL ASSEMBLY REQUIREMENTS.....	2.1-22
3.8 HIGH ACCURACY SUN SENSOR REQUIREMENTS.....	2.1-23
3.9 FOCAL PLANE ASSEMBLY REQUIREMENTS.....	2.1-24
3.9.1 Camera Assembly.....	2.1-24
3.9.1.1 Camera Performance Parameters.....	2.1-24
3.9.1.2 Camera Component Elements.....	2.1-24
3.9.2 Detector Housing Assembly.....	2.1-25
3.9.2.1 Housing.....	2.1-25
3.9.2.2 Vacuum Door Assembly.....	2.1-25
3.9.3 Flight Spacer.....	2.1-26
3.9.4 Light Baffle.....	2.1-26
3.9.5 Radiation Shielding.....	2.1-26
3.10 HYPERBOLOID STOP/LIGHT SOURCE REQUIREMENTS.....	2.1-26
3.10.1 Hyperboloid Stop.....	2.1-26
3.10.2 UV Light Source.....	2.1-26
3.11 HVPS ASSEMBLY REQUIREMENTS.....	2.1-26
3.12 TELESCOPE MOUNT REQUIREMENTS.....	2.1-27
3.13 POWER ELECTRONICS BOX ASSEMBLY REQUIREMENTS.....	2.1-27
3.14 DATA ELECTRONICS BOX ASSEMBLY REQUIREMENTS.....	2.1-28

3.14.1	Data Requirements.....	2.1-28
3.14.2	Timing Requirements.....	2.1-30
3.14.3	Motor Control Electronics .....	2.1-30
3.15	STRUCTURAL/MECHANICAL DESIGN REQUIREMENTS.....	2.1-30
3.16	POINTING AND ALIGNMENT REQUIREMENTS .....	2.1-31
3.17	ELECTRICAL REQUIREMENTS.....	2.1-32
3.18	THERMAL REQUIREMENTS.....	2.1-33
3.19	DATA MANAGEMENT SUBSYSTEM REQUIREMENTS.....	2.1-35
3.20	SOFTWARE REQUIREMENTS.....	2.1-36
3.20.1	Software Standards.....	2.1-36
3.20.2	Flight Software Requirements.....	2.1-36
3.20.3	EGSE Software.....	2.1-38
3.21	PHYSICAL REQUIREMENTS.....	2.1-40
3.22	GROUND SUPPORT EQUIPMENT REQUIREMENTS .....	2.1-40
3.22.1	General.....	2.1-40
3.22.2	Electrical Ground Support Equipment.....	2.1-41
3.22.3	Mechanical Ground Support Equipment.....	2.1-42
3.23	SAFETY AND MISSION ASSURANCE REQUIREMENTS.....	2.1-42
3.23.1	Quality Assurance .....	2.1-42
3.23.2	Reliability .....	2.1-42
3.23.3	Safety .....	2.1-42
3.23.4	Software Quality Assurance.....	2.1-42
3.24	MAINTAINABILITY REQUIREMENTS.....	2.1-43
3.25	Deleted.....	2.1-43
3.26	ENVIRONMENTAL REQUIREMENT.....	2.1-43
3.26.1	Prelaunch.....	2.1-43
3.26.2	Launch / Ascent.....	2.1-43
3.26.3	On-Orbit.....	2.1-44
3.26.4	Ground Handling, Storage and Transportation Environment.....	2.1-44
3.27	TRANSPORTATION AND STORAGE REQUIREMENTS .....	2.1-44
3.28	DESIGN AND CONSTRUCTION REQUIREMENTS .....	2.1-45
3.29	LOGISTICS REQUIREMENTS.....	2.1-49
3.30	PERSONNEL AND TRAINING REQUIREMENTS.....	2.1-49
3.31	EXTERNAL INTERFACER REQUIREMENTS .....	2.1-49
4.0	VERIFICATION.....	2.1-50
4.1	GENERAL.....	2.1-50
4.2	VERIFICATION METHODS.....	2.1-50
4.3	VERIFICATION PHASES.....	2.1-51
4.4	VERIFICATION LEVELS .....	2.1-51
4.5	VERIFICATION REQUIREMENTS MATRIX.....	2.1-52
4.6	VERIFICATION SOFTWARE.....	2.1-52
4.7	VERIFICATION FACILITIES AND EQUIPMENT .....	2.1-52
5.0	PREPARATION, PACKAGING, AND SHIPMENT.....	2.1-52
5.1	MAINTAINING CONTROLLED ENVIRONMENT.....	2.1-52
5.2	PROTECTIVE COVERS.....	2.1-53
5.3	SHIPPING CONTAINERS.....	2.1-53
5.4	REMOVE BEFORE FLIGHT ITEMS .....	2.1-53
5.5	SPECIAL INSTRUCTIONS.....	2.1-53
5.6	SHIPPING.....	2.1-53
APPENDIX A	.....	2.1-54

## LIST OF FIGURES

3.1-1	SXI Configuration on the GOES Yoke.....	2.1-16
3.1-2	Block Diagram of SXI to GOES Satellite Interfaces.....	2.1-17
3.1-3	Telescope Layout, Conceptual .....	2.1-18
3.31-1	EUV Interface Diagram.....	N/A

**EXAMPLE**



LIST OF TABLES

3.3-1	Spectral Sensitivity Requirements .....	2.1-19
3.4-1	Encircled Energy Requirements and Goals .....	2.1-20
3.7-1	Filter Requirements .....	2.1-22
3.13-1	Low Voltage Power Characteristics.....	2.1-28
3.15-1	Glass Factors of Safety.....	2.1-31
3.17-1	HASS Power Characteristics .....	2.1-33
3.18-1	Component Temperature Ranges.....	2.1-34
3.18-2	Electrical Dissipation.....	2.1-34
3.21-1	Maximum Mass.....	2.1-40
3.28-1	Radiated Susceptibility Requirements .....	2.1-47
3.28-2	Radiated Susceptibility Requirements for Discrete Frequencies .....	2.1-47
3.28-3	Conducted Emission Limits .....	2.1-47

**EXAMPLE**

LIST OF ACRONYMS AND ABBREVIATIONS

Å	Angstroms
ADP	Automatic Data Processing
CCD	Charge Coupled Device
CCSDS	Consultative Committee for Space Data Systems
CEI	Configuration End Item
dc	direct current
EEE	Electrical, Electronic, and Electromechanical
EGSE	Electrical Ground Support Equipment
EMC	Electromagnetic Compatibility
EUV	Extreme Ultraviolet
eV	electron Volt
FOT	Fiber Optic Taper
FOV	Field of View
GOES	Geostationary Operational Environmental Satellite
GSE	Ground Support Equipment
GSFC	Goddard Space Flight Center
HASS	High Accuracy Sun Sensor
HVPS	High Voltage Power Supply
IMP	Instrument Mounting Panel
in.	inches
IR	Infrared
IRD	Interface Requirements Document
LVPS	Low Voltage Power Supply
MCP	Microchannel Plate
MDL	Multiuse Data Link
MGSE	Mechanical Ground Support Equipment
MLI	Multilayer Insulation
ms	milliseconds
MS-DOS	Microsoft Disk Operating System
MSFC	Marshall Space Flight Center
NASA	National Aeronautics and Space Administration
NDE	NonDestructive Evaluation
NRZ-M	Non-Return to Zero - Mark
PAP	Product Assurance Plan
PCM	Pulse Code Modulation
RAM	Random Access Memory
ROM	Read Only Memory
sec	seconds
SOCC	Satellite Operations Control Center
SPP	Sun Pointing Platform
SS/L	Space Systems/Loral
SXI	Solar X-ray Imager
TBD	To Be Determined
TCS	Thermal Control Subsystem
v	volts
XRP	X-ray Positioner

SOLAR X-RAY IMAGER  
CONFIGURATION END ITEM SPECIFICATION  
PART I

1.0 **INTRODUCTION**

1.1 **SCOPE**

This specification establishes the design, fabrication, performance, and verification requirements for the Solar X-ray Imager (SXI), the requirements for associated ground support equipment, and the associated functional software requirements.

1.2 **OBJECTIVE**

The SXI's purpose is to provide repetitive images of solar activity in selected X-ray wavelength bands for real time monitoring of solar events for use in solar forecasting.

2.0 **DOCUMENTATION**

2.1 **APPLICABLE DOCUMENTS**

The following documents, of the latest revision unless otherwise specified, form a part of this specification to the extent specified herein. In the event of conflict between documents referenced herein and the contents of this specification, the contents of this specification shall be considered a superseding requirement.

2.1.1 **Marshall Space Flight Center Documents**

MM5300.12	MSFC Part and Material Traceability
MM8070.2	MSFC Specifications and Standards, Approved Baseline List
MM8075.1	MSFC Software Management and Development Requirements Manual
MMI8040.15	Configuration Management
MSC-JD-001	Crimping of Electrical Connections
MSFC-HDBK-505A	Structural Strength Program Requirements
MSFC-HDBK-527	Materials Selection List for Space Hardware Systems
MSFC-PLAN-1975	Software Quality Assurance Plan for the Solar X-ray Imager
MSFC-PLAN-2236	Verification Plan for the Solar X-ray Imager
MSFC-PLAN-2241	Product Assurance Plan for the Solar X-ray Imager
MSFC-PLAN-2242	SXI Contamination Control and Implementation Plan
MSFC-PLAN-2252	Integration and Assembly Plan for the Solar X-Ray Imager
MSFC-PLAN-TBD	Calibration Plan for the Solar X-Ray Imager
MSFC-PROC-404B	Drying and Preservation, Cleanliness Level and Inspection Methods for Gases

MSFC-SPEC-1198	Screening Requirements for Nonstandard EEE Parts
MSFC-SPEC-1493	Electrostatic Discharge Control Requirements
MSFC-SPEC-2112	SXI Software Requirements Specification
MSFC-SPEC-250A	General Specification for Protective Finishes for Space Vehicles Structures and Associated Flight Equipment
MSFC-SPEC-445	Adhesive Bonding, Process and Material Inspection
MSFC-SPEC-494	Installation of Harness Assembly Electrical Wiring
MSFC-SPEC-521B	Electromagnetic Compatibility Requirements on Spacelab Payload Equipment
MSFC-SPEC-522	Design Criteria for Controlling Stress Corrosion and Cracking
MSFC-SPEC-708	Identification Markers for Space Systems Electrical Harnesses
MSFC-STD-1249	Standard NDE Guidelines and Requirements for Fracture Control Programs
MSFC-STD-246	Design and Operations Criteria of Controlled Environment Areas
MSFC-STD-355	Radiographic Inspection of Electronic Parts
MSFC-STD-383C	Rubber Stamping of Electrical Equipment and Components
MSFC-STD-397	Radiographic Laboratory Qualification
MSFC-STD-486A	Torque Limits for Threaded Fasteners
MSFC-STD-506	Materials and Processes Control
MSFC-STD-531	High Voltage Design Criteria
MSFC-STD-555	MSFC Engineering Documentation Standard
MSFC-STD-557	Usage Criteria for Spacecraft Applications of 6A1-4V Titanium Alloy Threaded Fasteners
MSFC-STD-781	Standard for Electrical Contacts, Retention Criteria

### 2.1.2 **Goddard Space Flight Center Documents**

S-415-001	Requirements Specification for the Solar X-ray Imager for the GOES L/M Spacecraft
X-601-84-3	The Space Radiation Environment for GOES Missions

### 2.1.3 **Space Systems / Loral Documents**

SJ-E007077	Interface Requirements Document for Solar X-ray Imager to GOES
------------	--

### 2.1.4 **Other Documents**

CCSDS-102.0-B-2	CCSDS Standards - Packet Telemetry Blue Book
MIL-STD-100E	Military Standard Engineering Drawing Practices
JSC-SP-R-0022A	General Specification, Vacuum Stability Requirements of Polymeric Material for Spacecraft Application

MIL-B-5087	Bonding, Electrical, and Lightning Protection, for Aerospace Systems
MIL-B-7883B	Brazing of Steels, Copper Alloys, Nickel Alloys, Aluminum and Aluminum Alloys
MIL-HDBK-17B	Military Handbook, Polymer Matrix Composites
MIL-HDBK-5E	Metallic Materials and Elements for Aerospace Vehicle Structures
MIL-STD-1285	Marking of Electrical and Electronics Parts
MIL-STD-129	Marking for Shipment and Storage
MIL-STD-130F	Identification Marking of U.S. Military Property
MIL-STD-1515A	Fastener Systems for Aerospace Applications
MIL-STD-975	NASA Standard Electrical, Electronic, and Electromechanical (EEE) Parts List
NASA SP-8013	Meteorite Environment Model
NASA-STD-2100-91	NASA Software Documentation Standard Software Engineering Program
NHB5300.4(1D-2)	Safety, Reliability, Maintainability and Quality Provisions for the Space Shuttle Program
NHB5300.4(3A-1)	Requirements for Soldered Electrical Connections
NHB5300.4(3G)	Requirements for Interconnecting Cables, Harnesses, and Wiring
NHB5300.4(3H)	Requirements for Crimping and Wire Wrap
NHB5300.4(3I)	Requirements for Printed Wiring Boards
NHB5300.4(3J)	Requirements for Conformal Coating and Staking of Printed Wiring Boards and Electronic Assemblies
NHB5300.4(3K)	Design Requirements for Rigid Printed Wiring Boards and Assembly
NHB6000.1C	Requirements for Packaging, Handling, and Transportation for Aeronautical and Space System Equipment and Associated Equipment
NHB8060.1	Flammability, Outgassing and Odor Requirements and Test Procedures for Materials for Environments that Support Combustion
SSP30425	Space Station Program Natural Environment Definition for Design

## 2.2 REFERENCE DOCUMENTS

The following documents contain material referenced in this document.

MSFC-PLAN-2111	SXI Software Management, Development, and Test Plan
NAS8-39041, Attachment J-1	Solar X-ray Imager Sun Sensor Specification
NAS8-39409, Appendix A	Stepper Motor/Encoder Unit for the Solar X-ray Imager
S-415-001	Requirements Specification for the Solar X-ray Imager for the GOES L/M Spacecraft
SS/L-TR00750A	Solar X-ray Imager (SXI) Accommodation Study, Volume I- Final Technical Report
SXI-MA-SPEC-001	Mirror Specification for the Solar X-ray Imager

### 3.0 **REQUIREMENTS**

The following paragraphs contain specific requirements to which SXI shall be designed and fabricated, and the operational performance SXI shall meet. These requirements shall be the basis for verification of SXI as included in section 4.0.

Paragraph 3.1 contains general requirements for SXI and paragraphs 3.2 and 3.3 contain high level requirements which apply to the operation and performance of SXI. Paragraphs 3.4 through 3.14 contain requirements specific to hardware assemblies which make up SXI. Paragraphs 3.15 through 3.19 cover subsystem requirements which apply across several hardware assemblies. Paragraph 3.20 covers SXI software, including GSE software. Paragraphs 3.21 and 3.23 through 3.30 covers SXI requirements pertaining to various disciplines (e.g. reliability, safety) Paragraph 3.31 covers external interface requirements for both the EUV and the GOES satellite.

#### 3.1 **GENERAL REQUIREMENTS**

The Solar X-ray Imager consists of an x-ray image detector, an optical system for focusing an image of the sun onto the x-ray image detector through any one of a set of filters, a high accuracy sun sensor (HASS) to monitor the solar aspect angles relative to the instrument line-of-sight at image integration time, and interfaces to spacecraft telemetry, electrical power and command subsystems.

A conceptual representation of the SXI configuration on the GOES solar array yoke is shown in Figure 3.1-1. This figure identifies the general location of the SXI telescope and electronics boxes. Figure 3.1-2 is a simplified block diagram depicting the major SXI components and their interfaces to the GOES satellite. Figure 3.1-3 is a conceptual layout of the SXI telescope, and has identified each of the major assemblies.

The Geostationary Operational Environmental Satellite (GOES) -L will provide a sun pointing platform (SPP) and control to maintain the SXI optical axis pointed at the center of the solar disk to within 3 arc-min in elevation and 4.8 arc-min in azimuth.

The spatial resolution, sensitivity, and dynamic range specified are intended to be sufficient to allow the reconstruction of such solar features as active regions, loops, and coronal holes and the site of flares with enough detail for operational purposes.

##### 3.1.1 **Internal Performance Verification**

The SXI shall include a ground commandable internal subsystem to generate internal test signals which can be used both on orbit and during spacecraft integration and test to verify the integrity of the total SXI system. If it is not practical for this subsystem to include realistic excitation of the image detection system then a means to do this using a removable test fixture shall be provided for use during spacecraft thermal vacuum testing.

##### 3.1.2 **Scientific Performance**

The scientific performance of the as-built instrument shall be determined by calibration at both subassembly and assembly levels in accordance with MSFC-PLAN-TBD.

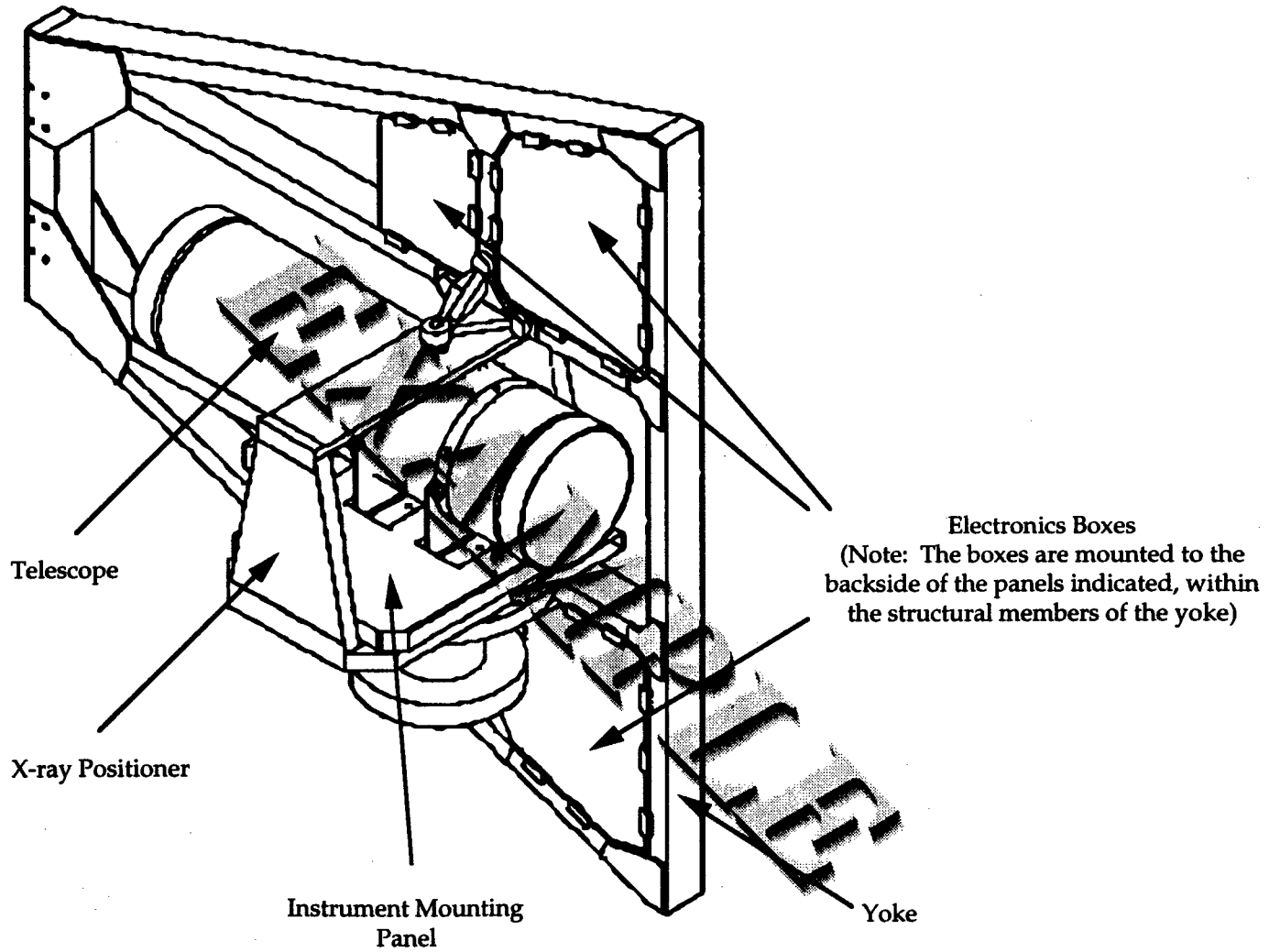

Figure 3.1-1 SXI Configuration on the GOES Yoke

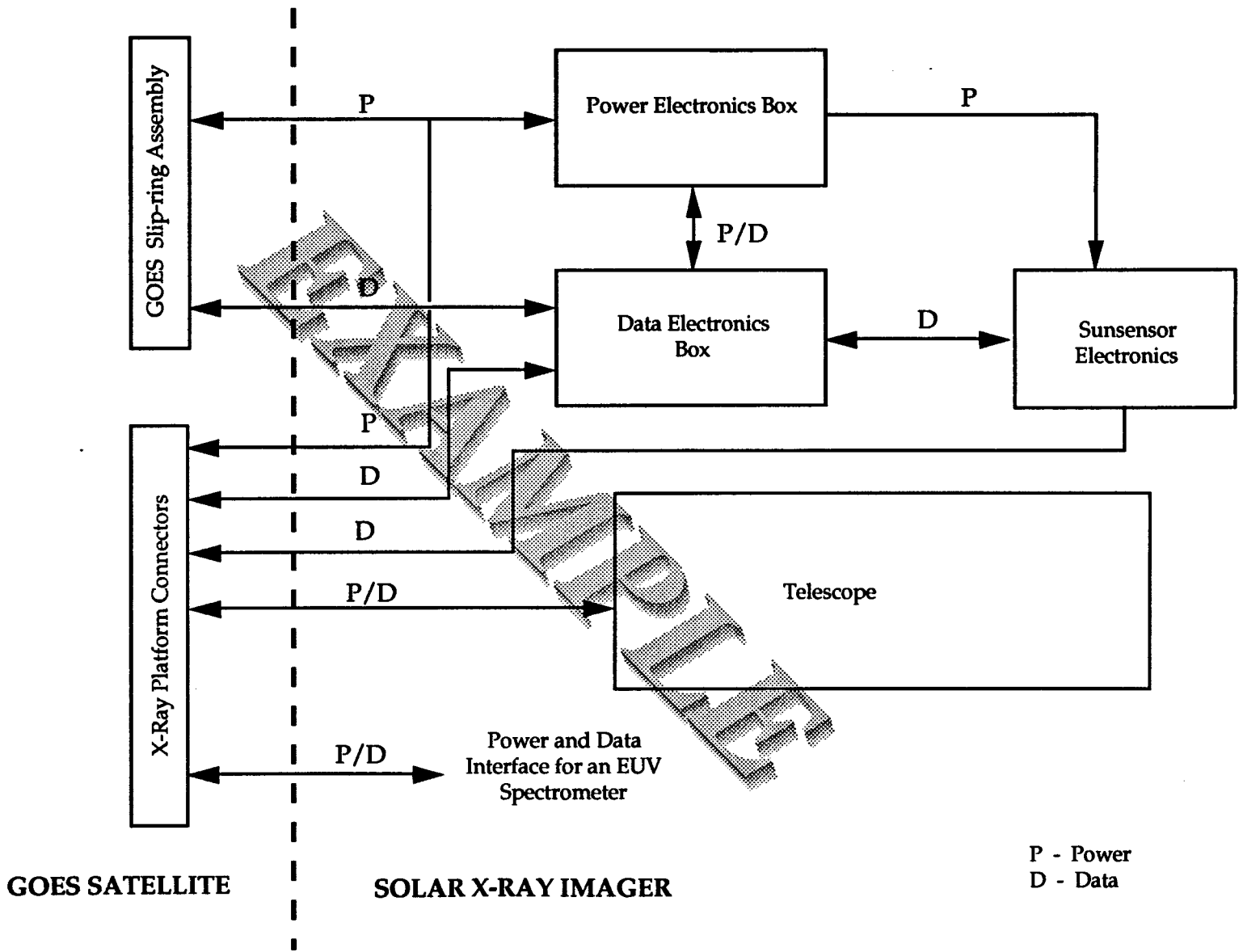

Figure 3.1-2 Block Diagram of SXI to GOES Satellite Interfaces



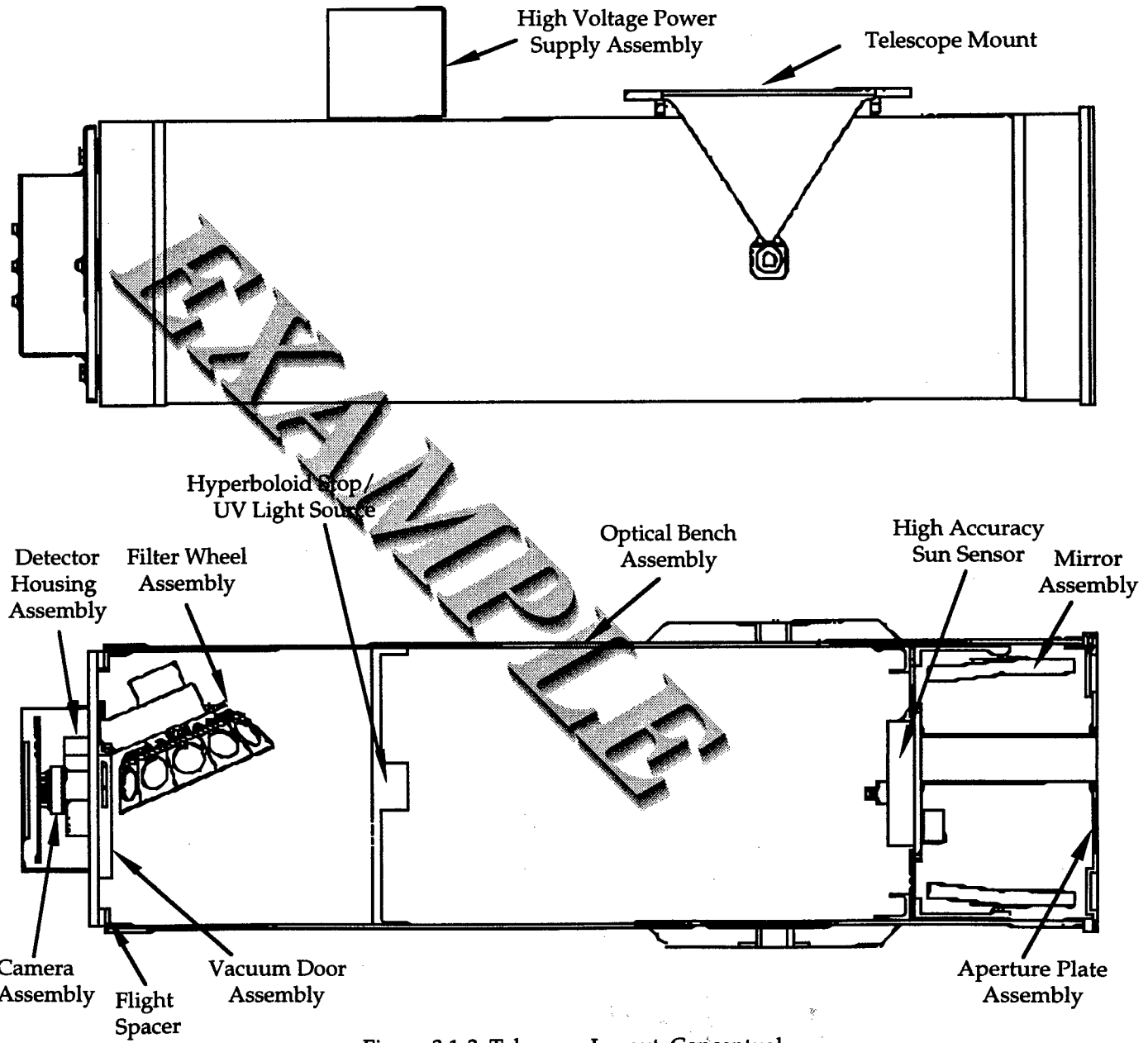

Figure 3.1-3 Telescope Layout, Conceptual

### 3.2 OPERATIONS REQUIREMENTS

#### 3.2.1 Time of Operation

SXI shall meet all performance requirements while in the orbiting geosynchronous spacecraft, within 168 hours after power up, and from 30 minutes after spacecraft dawn until spacecraft sunset.

#### 3.2.2 Insertion into Orbit

SXI shall survive for a maximum of 2.5 hours in an unpowered configuration during post launch deployment, after which time heater power will be available.

#### 3.2.3 Operational Life

SXI shall be designed for an on-orbit operational life of 3 years, with a goal of 5 years.

#### 3.2.4 Modes of Operation

The SXI instrument operates in one of 4 modes:

1) Standby Mode. In this mode, the SXI executes routines designed to provide diagnostic information, and gradual activation of the various SXI subsystems. This mode is governed by SXI software routines, using ground commands to step from state-to-state.

2) Image Acquisition. In this mode, the SXI is imaging the sun, downlinking image data and/or statistics. Control of imaging is either via ground command or control tables loaded into the SXI software.

3) Safe Mode. In this mode, the SXI is in a "safe" state designed to prevent damage to SXI subsystems susceptible to damage when used for routine activity. In this mode, the SXI awaits commands from the ground.

4) Survival. In this mode, the SXI is inactive. Temperatures are maintained within non-operational mission-allowable limits through the use of thermostatically controlled heaters.

### 3.3 PERFORMANCE REQUIREMENTS

#### 3.3.1 Image Bandwidth

The x-ray image data shall consist of near real-time solar images in the spectral range from at least 6 to 60 Å (photon energy 3000/200 eV).

#### 3.3.2 Spectral Sensitivity

The instrument, including optics and filters, shall be capable of detecting the flux levels indicated in Table 3.3-1, using an integration time of 100ms or less, for the various filter combinations for radiant flux emanating from an extended source. The "capable of detecting" provision shall mean that the signal amplitude is 3 sigma referred to the on-orbit noise conditions.

Spectral Band*	Source	Min Detectable Flux ergs cm <sup>-2</sup> arcsec <sup>-2</sup> sec <sup>-1</sup>
6 - 20 Å	Al 8.3 Å	1.5 X 10 <sup>-8</sup>
6 - 60 Å	C 44 Å	6 X 10 <sup>-8</sup>

\*The above spectral sensitivity requirements must be met with the combination of the filter wheel component and selected prefilter.

**Table 3.3-1 Spectral Sensitivity Requirements**

### 3.3.3 Response to Charged Particles

SXI shall be designed to operate in the geostationary orbit trapped charged particle environment with a worst case degradation due to spurious detector signals which shall not exceed the response to the minimum detectable signal defined in 3.3.2.

## 3.4 MIRROR ASSEMBLY REQUIREMENTS

SXI shall contain a grazing incidence mirror assembly which consists of a mirror set, supporting structure, and mounting ring. The mirror assembly is defined in SXI-MA-SPEC-001.

### 3.4.1 Encircled Energy

Image encircled energy is specified on the flat image surface at the principal focus of the mirror assembly. The required minimum encircled energy percentages shall be as specified in Table 3.4-1.

Wavelength h Å	Encircled-energy percentage within 5 arc-seconds diameter at 0 arc-minutes field angle		Encircled-energy percentage within 20 arc-seconds diameter at 20 arc-minutes field angle	
	Requirement	Goal	Requirement	Goal
8.3	40%	50%	50%	52%
44.8	56%	70%	52%	53%

Table 3.4-1 Encircled Energy Requirements and Goals

### 3.4.2 Effective Area

The effective area of the mirror assembly that images an infinitely distant on-axis x-ray point source, with a wavelength of 8.3 Å shall be maximized. A minimum of 1.5cm<sup>2</sup>, for 8.3Å, and 4.2cm<sup>2</sup>, for 44.8Å, is required for the flight mirror assembly.

### 3.4.3 Focal Distance

The axial position of best focus for paraxial rays shall be 65.0 plus zero/minus .5cm behind the plane defined by the intersection of the two reflecting surfaces. After fabrication, the actual measured position of best focus of the mirror assembly shall be determined to a precision of ±0.001cm.

### 3.4.4 Alignment Reference

An alignment reference mirror shall be on a portion of the front (edge) surface of the first paraboloid/hyperboloid mirror. The alignment reference shall be optically flat to within one quarter of 5461Å. The area of the reference mirror shall be at least five cm<sup>2</sup> and suitable for autocollimation purposes. The normal to this alignment mirror shall be parallel to the telescope optic axis to within 30 arc-seconds with a goal of 10 arc-seconds.

### 3.4.5 Off Axis Mirror Resolution

The mirror shall be capable of resolving two point sources at infinity separated by 15 arc-seconds located anywhere within 15 arc-min of the optical axis.

### 3.4.6 Mirror Geometry

The axial length of the reflecting surfaces on each mirror shall not exceed 4.75cm.

### 3.4.7 **Mirror Mass**

The mirror assembly shall weigh less than 3kg.

### 3.4.8 **Resonant Frequency**

The constrained resonant frequency of the mirror assembly shall be greater than 200Hz.

### 3.4.9 **Optical Axis Location**

The location of the optical axis of the mirror assembly shall fall within a circle of radius 0.0127cm centered at the center of a circle defined by the attachment points of the mounting ring. The location shall be measured to within  $\pm 0.0025$ cm.

### 3.4.10 **Mirror Temperature Monitoring**

The mirror assembly shall include a thermistor, as specified in the Interface Requirements Document for Solar X-Ray Imager, hereafter referred to as the IRD, for passive temperature monitoring by the GOES PCM telemetry. An active temperature sensor shall be provided for temperature monitoring by the SXI housekeeping subsystem.

## 3.5 **OPTICAL BENCH ASSEMBLY REQUIREMENTS**

SXI shall provide an optical bench assembly which consists of an optical bench, support ring flanges, and secondary support structure. The optical bench assembly shall provide a light weight, stable mounting structure for the optical/mechanical components of SXI.

### 3.5.1 **Unfocused Light**

No light leakage shall be allowed which would produce a measurable background noise increase in the detector for integration periods of up to 16 sec.

### 3.5.2 **Outgassing**

Internal outgassing of water and other volatiles by the optical bench shall not exceed TBD.

### 3.5.3 **Venting**

The optical bench assembly shall provide a means for venting internal gases during launch/ascent to prevent contamination of components and damage to pressure sensitive materials.

#### 3.5.3.1 **Vent Rate**

The instrument shall be vented at a minimum TBD rate to preclude damage to filters.

## 3.6 **APERTURE PLATE ASSEMBLY REQUIREMENTS**

SXI shall provide an aperture plate assembly consisting of an aperture plate, prefilters, and baffles if required. The aperture plate assembly shall prevent unreflected x-rays from reaching the image plane. The aperture plate assembly shall be located in front of the mirror and defines the mirror aperture.

### 3.6.1 **Aperture Plate**

The aperture plate shall not obscure more than 10% of the frontal area of the mirror, nor will it vignette targets at infinity within half a degree of the optical axis.

### 3.6.2 **Prefilters**

IR, UV, and visible light prefilters shall be located at the telescope entrance. The prefilters shall transmit x-rays with wavelengths shorter than  $60\text{\AA}$  with an efficiency greater than 5%. They shall

provide a thermal reflecting surface and have a total transmittance to UV and visible light (wavelengths greater than 1000Å) of less than 10<sup>-3</sup>.

**3.6.2.1 Prefilter Frames**

The prefilter frames shall not contribute to the obscuration of the mirror or to the vignetting of the image except as described by section 3.6.1.

**3.7 FILTER WHEEL ASSEMBLY REQUIREMENTS**

SXI shall provide a filter wheel assembly which consists of a filter wheel, filter wheel motor, filters, filter frames and a mounting bracket. The filter wheel assembly shall be designed to limit any amplification of the launch environment that will be experienced by the filters.

**3.7.1 Filter Wheel**

A filter wheel with 12 positions for broadband spectral filters shall be provided.

**3.7.1.1 Filter Wheel Location**

The filter wheel shall be located such that the plane containing the filter being illuminated shall be no closer than 0.75in to the focal plane, in order to minimize the effect on the image of any non-uniformity in the filter materials.

**3.7.2 Filters**

The filters provided, when used in conjunction with the prefilter and the x-ray mirror, shall select the wavebands indicated in Table 3.7-1.

Filter Qty	Material	Waveband Å
5	TBD	6 - 60
2	Beryllium, 12.7 micron	6-20
1	Beryllium, 25.4 micron	6-16
1	Beryllium, 50.8 micron	6-12
1	Stainless Steel, 200 micron	0
1	Open	∞
1	UV, Quartz/Sapphire	>1500

**Table 3.7-1 Filter Requirements**

**3.7.2.1 Filter Size**

The filters shall be sized so as not to obstruct or vignette the field of view.

**3.7.2.2 Filter Mass**

The filter wheel assembly shall be capable of accommodating ten filters of negligible mass (as compared to the filter frame) and two filters, each with a mass of up to 2 grams. The filter wheel shall be balanced about the axis of rotation so as not to degrade the performance of the filter wheel motor.

**3.7.3 Filter Wheel Motor**

SXI shall provide a brushless dc stepper motor and position encoder to turn the filter wheel and verify location. Absolute knowledge of the filter wheel position at each of 12 evenly spaced positions shall be provided. Detailed requirements for the motor are specified in contract NAS8-39409.

### 3.7.3.1 Filter Wheel Rotation

The motor shall be designed to operate as an intermittent duty unit with the duty cycle of 2 revolutions in 20 seconds, off for 20 seconds, repeated every 40 seconds for a total of 4 million cycles. (One cycle is two revolutions).

### 3.7.3.2 Motor Torque Requirements

The motor output shaft speed shall be at least 6 revolutions/minute at a minimum output torque of 5.5 ounce inches, approximately 8-times the minimum torque required to turn the filter-wheel. These values shall be obtained when the motor is provided with +24V power.

### 3.7.3.3 Filter Wheel Operating Torque

The filter wheel motor shall nominally be operated at +12V dc, providing 1/2 of the maximum motor torque, approximately 4-times the minimum torque required to turn the filter-wheel.

For limited duration, emergency operations, the filter-wheel motor can be operated at +24V. This operation requires a ground command to change the power supply output voltage.

### 3.7.3.4 Bi-directional Rotation

The motor and control electronics shall provide for bi-directional rotation of the filter wheel.

### 3.7.3.5 Settling Time

The time to turn to an adjacent filter position and settle such that the field of view of the imaging detector is entirely covered by a single filter-wheel filter shall be no greater than 5 seconds.

### 3.7.4 Ultraviolet Disperser

The ultraviolet disperser shall provide flat field illumination of the x-ray detector. It shall transmit radiation with wavelengths longer than 1500Å and shall weigh no more than 2 grams.

### 3.7.5 Radiation Shield

The radiation shield shall be mounted on the filter wheel and shall provide partial shielding for the x-ray detector against energetic particles, and shall weigh no more than 2 grams.

## 3.8 HIGH ACCURACY SUN SENSOR REQUIREMENTS

SXI shall provide a HASS. Detailed requirements for the HASS are documented in contract NAS8-39041 Attachment J-1. The HASS shall provide solar pointing information to be used in ground processing to locate the center of the solar image relative to the SXI boresight.

### 3.8.1 Field of View

The HASS shall have a field of view no less than 2 degrees by 2 degrees.

### 3.8.2 Accuracy

The HASS shall provide data (error) signals which indicate the offset of the pointing axis of the HASS from the center of the solar disk in two mutually orthogonal axes (pitch and yaw) with an absolute accuracy of better than 1 arc minute when the center of the solar disk is within a 42 arc-min field of view centered on the HASS's optical axis.

### 3.8.3 Resolution

The resolution of the HASS shall be better than 5 arc-sec in each axis.

### 3.8.4 Short Term Stability

The total short term drift of the HASS shall not exceed 5 arc-sec/min. "Short term" is defined as periods of 5 minutes in which the HASS operating temperature does not vary by more than 2°C.

### 3.8.5 Integration Time

The HASS integration time, the time over which the sensor needs to be illuminated in order to distinguish a change in the pointing direction of 2.5 arc-sec or more, shall be 30 msec or less.

### 3.8.6 Alignment Reference

The HASS shall provide an alignment mirror to permit bore sighting of the HASS optical axis. The normal of the alignment mirror shall be parallel to the HASS optical axis to within 1 arc-min. The alignment knowledge of the reference with respect to the sensor's optical axis shall be better than 5 arc-sec.

### 3.8.7 Solar Pointing Data Readout Frequency

HASS data shall be available for telemetering to the SXI within 100 msec of the command to initiate a measurement.

## 3.9 FOCAL PLANE ASSEMBLY REQUIREMENTS

SXI shall contain a focal plane assembly which consists of a camera assembly, detector housing assembly, spacer and radiator.

### 3.9.1 Camera Assembly

SXI shall include a camera assembly consisting of 1) a microchannel plate x-ray photosurface and electron gain mechanism, 2) a phosphor layer for visible photon conversion, 3) a fiber optic image coupling, 4) a solid state area imaging detector, and 5) associated sequencing and data electronics.

#### 3.9.1.1 Camera Performance Parameters

##### 3.9.1.1.1 Geometric Characteristics

The camera system shall provide a minimum of 512 by 512 square aspect ratio pixels for the covered effective field of view of 42 by 42 arc-minutes. The pixel size shall be 5 by 5 arc-seconds.

##### 3.9.1.1.2 Operating Characteristics

###### 3.9.1.1.2.1 Dynamic Range

When measured with monochromatic illumination in the 10 to 20Å range, the detector response through the instrument shall be linear within +/-0.3 percent of full scale over a minimum factor of 300 above the minimum detectable signal defined in 3.3.2.

###### 3.9.1.1.2.2 Blooming

The image detector shall be selected to minimize the spreading of an illuminated area when the incident flux exceeds the designed dynamic range.

###### 3.9.1.1.2.3 Integration

The camera assembly shall be capable of supporting integration times from 1ms to 4sec. Nominal integration time shall be minimized by design to avoid image smearing by solar motion or platform jitter.

#### 3.9.1.2 Camera Component Elements

The camera assembly shall be comprised of the component elements described below.

##### 3.9.1.2.1 Microchannel Plate Element

The photosensitive detection element of the camera shall be an 18mm active area microchannel plate having a pore size of 8 microns. The thickness of the plate shall be approximately a 60:1 ratio of

the pore diameter. The plate shall be processed to provide a high channel bias current to maximize the dynamic range of the MCP gain. The bias angle of the plate shall be 0°.

#### 3.9.1.2.1.1 MCP Storage

The MCP shall be stored in a clean, oil free, dry environment with no greater than TBD humidity (or TBD ppm water) and TBD cleanliness level.

#### 3.9.1.2.1.2 MCP Operating Pressure

The MCP shall be under pressure of  $1 \times 10^{-6}$  torr or better while operating.

#### 3.9.1.2.1.3 MCP Contamination Protection

After SXI deployment, the MCP shall remain protected from contamination due to outgassing of materials for TBD hours.

#### 3.9.1.2.2 Fiber Optic Coupler

The camera assembly shall include a fiber optic coupler to transmit the converted/amplified image to the readout detector array. The fiber optic coupler shall be composed of 6 micron fibers and provide for taper magnification/minification as required to match the focal plane plate scale to the selected detector pixel area.

#### 3.9.1.2.3 Solid State Array Detector

The readout detector shall be a solid state array with a minimum of 512 rows of 512 elements per row. The aspect ratio of the pixels shall be square.

#### 3.9.1.2.4 Camera Assembly Temperature Monitors

The camera assembly shall include a thermistor as specified in the IRD, for passive temperature monitoring by the GOES PCM telemetry. Active temperature sensors shall be provided for temperature monitoring by the SXI housekeeping subsystem.

### 3.9.2 Detector Housing Assembly

SXI shall contain a detector housing assembly which consists of a structural housing, vacuum door assembly and charge/vacuum port(s), etc. The detector housing assembly shall provide a controlled environment for the MCP during storage and ground operation. The storage environment provided shall be per 3.9.1.2.1.1. The on-orbit environment provided shall be per 3.9.1.2.1.2 and 3.9.1.2.1.3.

#### 3.9.2.1 Housing

The housing shall provide for the mounting, alignment, and positioning of the discrete camera component elements (MCP, fiber optic coupler, CCD array, and drive electronics).

#### 3.9.2.1.1 Detector Housing Feedthroughs

The housing shall provide vacuum type electrical connection feedthroughs for the following:

- HVPS - 1000V supply line
- HVPS - 5000V supply line
- HVPS - signal return line
- MCP - heater supply line

A feedthrough shall also be provided for a vacuum line. The combined leak rate of all housing penetrations shall be less than TBD.

#### 3.9.2.2 Vacuum Door Assembly

SXI shall provide a vacuum door and window for ground checkout purposes.



### 3.9.2.2.1 Door Position Sensor

The vacuum door assembly shall provide a position sensor such that it can be determined that the door is in the open position.

### 3.9.2.2.2 Window

The vacuum door assembly shall contain a window which will transmit ultraviolet light below 2000Å.

### 3.9.2.2.3 Door Actuation

The door shall be actuated one time on-orbit by ground command.(i.e. manual reset of the door).

### 3.9.2.2.4 Door Seals

The door seals shall be designed such that the vacuum box can sustain a vacuum of  $1 \times 10^{-6}$  torr in order to operate the MCP for instrument checkout. The door seals shall be designed to sustain the prelaunch environment defined in section 3.26 while on the pad.

### 3.9.3 Flight Spacer

SXI shall provide a flight spacer for focal length adjustment.

### 3.9.4 Light Baffle

TBD

### 3.9.5 Radiation Shielding

SXI shall provide the maximum shielding practicable for the detector, within the specified weight and volume limits, in order to minimize individual pixel response to discrete high energy events.

## 3.10 HYPERBOLOID STOP/LIGHT SOURCE REQUIREMENTS

### 3.10.1 Hyperboloid Stop

A hyperboloid stop shall be provided to prevent singly reflecting x-rays from reaching the focus. The stop shall be located 43.3 cm (two thirds of the focal length) behind the principal plane of the mirror.

### 3.10.2 UV Light Source

TBD

## 3.11 HVPS ASSEMBLY REQUIREMENTS

SXI shall provide a high voltage power supply to provide power to the microchannel plate and the UV lamp. The HVPS shall provide three supply lines as defined herein, and a power return line. The HVPS assembly shall also house the camera electronic module and provide a distribution structure for all cables interfacing to the SXI optical bench assembly.

### 3.11.1 5000V Programmable Supply Line

The HVPS shall provide a programmable supply line to the FOT aluminized layer with the following characteristics:

- 5000V full scale output
- $\pm 10$ V steady state accuracy
- 10 microAmps current
- Average voltage programmable to 50V resolution

### 3.11.2 Programmable Supply Line

The HVPS shall provide a programmable supply line to the MCP with the following characteristics:

- nominal duty cycle: 3.0 seconds/minute or lower
- 1000V full scale output
- average voltage programmable to 4V resolution
- maximum transition time\* per image: 500 microseconds
- steady state ripple: 5V or less
- 150 microAmps current

\*The transition time is the time required for the voltage to rise from 200V to within 5% of the steady state average value plus the time required for the voltage to fall from the steady state average value to a value below 200V. Actual rise and fall times need not be equal, so long as the total transition time meets the requirements of the above definition.

### 3.11.3 Packaging

The HVPS shall be packaged within a 6.25X3.25X3 in envelope, without connectors.

### 3.11.4 Mounting

The HVPS shall be housed and mounted on the optical bench.

### 3.11.5 Turn-on Sequence

The HVPS design shall permit application of the 5000V supply to the MCP prior to the application of the 1000V supply.

### 3.11.6 UV Lamp Power Supply

The HVPS shall provide a power supply for the UV lamp. This shall consist of a start up voltage of 550Vdc, with a sustain voltage of 120Vdc.

## 3.12 TELESCOPE MOUNT REQUIREMENTS

The telescope mount shall be designed to meet the requirements of the IRD, section 3.11.2 and 3.2.2.

## 3.13 POWER ELECTRONICS BOX ASSEMBLY REQUIREMENTS

SXI shall provide a power electronics box which shall supply low voltage power to the data subsystem, the HVPS, the EUV spectrometer, the filter wheel motor, the x-ray detector, the HASS, and distribute heater power to the thermal control subsystem.

### 3.13.1 Low Voltage Power Characteristics

The power electronics box shall supply the voltages with the corresponding characteristics indicated in Table 3.13-1.

Voltage	Supplied to	Total Load
+5V	Data subsystem Motor System Electronics HASS	3A
+5.2V	Data subsystem	.3A
-5.2V	Data subsystem	.2A
+20V	Data subsystem Camera HVPS EUV System HASS	.6A
-20V	Data subsystem EUV System HASS	.3A
+0/+12/+24V	Motor (off/nominal/emergency)	0/.2/.4A
20V*	heaters	512mA

\* Voltage shall be switchable, either +20 or -20V .

**Table 3.13-1 Low Voltage Power Characteristics**

### 3.13.1.1 Voltage Regulation

Voltage regulation shall be  $\pm 200\text{mV}$  for the 5V output and  $\pm 500\text{mV}$  for all other outputs.

### 3.13.1.2 Inrush Current Limit

Inrush current shall be set to TBD.

## 3.14 DATA ELECTRONICS BOX ASSEMBLY REQUIREMENTS

SXI shall provide a data electronics box which shall be used to control the SXI imaging capability, and interface the data to the GOES spacecraft for safety and health monitoring, and transmission of image data to the ground. The data electronics box shall also control interfaces to the SXI sun sensor and the EUV spectrometer.

### 3.14.1 Data Requirements

The data produced by SXI shall fall into three categories: image data, ancillary and housekeeping data, and safety telemetry.

The image data shall contain data from the imaging detector, the solar pointing angle contained within the data from the HASS, and all internal housekeeping or status required to reconstruct the image on the ground.

Ancillary data shall include all SXI housekeeping data, duplicates of the PCM telemetry, and additional EUV spectrometer and HASS data.

Safety telemetry shall include all data required for safety and health monitoring of the SXI by the SOCC. This data shall include temperature read from thermistors during eclipse, 3 analog voltages and 3 digital status lines. This data shall be provided to the low rate PCM telemetry stream.

#### 3.14.1.1 Image Availability

The SXI design shall permit completed image integration and transmission of a single full-CCD image within one minute of a command to image the sun, from either the ground or the control tables loaded into software.

### 3.14.1.2 MDL Data Link

The I-channel of the spacecraft Multi-Use Data Link (MDL) transmitter is dedicated to SXI for transmission of both image and ancillary data, to the ground. SXI shall use the MDL as described in the IRD, section 3.2.3.6.1, for the transmittal of imaging data (including EUV and HASS data) and all associated housekeeping data at a 100kbps rate. In order to maintain data synchronization, SXI shall transmit data continually, including fill patterns if no image is available.

### 3.14.1.3 Data Format

The SXI data shall be formatted in compliance with CCSDS standards.

#### 3.14.1.3.1 Data Content

In addition to solar data, SXI image data shall include the CCSDS headers, and all other information necessary for reconstruction of the solar image and EUV flux measurements.

### 3.14.1.4 Synchronization and Errors

Data format shall be chosen to facilitate maintaining bit, phase, and frame synchronization. Data coding shall be selected to facilitate detection of link transmission errors.

### 3.14.1.5 HASS Data

The data electronics box shall capture HASS data at the maximum HASS readout rate, and provide it to the ground in the image telemetry data. This data will provide the SXI pointing angle during the x-ray image integration. This data will be included in the image data packet sent to the MDL. Additional HASS data shall be used to form ancillary data packets.

### 3.14.1.6 EUV Data

The data electronics box shall capture EUV flux data at an average rate of at least one set of EUV measurements per minute.

### 3.14.1.7 On-Board Data Processing

The SXI data electronics box shall have full random access to the image data stored in memory including read capability. This shall allow processing of the data by software prior to downlink..

### 3.14.1.8 Filter Wheel Rotation Control

The data electronics box shall control the direction of rotation of the filter wheel and select the final position of the filter wheel upon command from the ground or software routines. In addition, the data subsystem shall be able to implement the emergency torque mode of the motor, upon command from the ground.

### 3.14.1.9 Onboard Image Processing Resolution

The data electronics box shall provide 10-bit analog-to-digital (A/D) resolution. Dual analog input channels to the A/D converter will be provided. One channel will preserve linearity; the second will have a logarithmic transfer function, to enhance resolution for low energy pixels.

Selection, for an entire image, of either the linear or non-linear channel shall be controlled by software.

### 3.14.1.10 Data During Eclipse

There is no requirement for data electronics box activity during an eclipse. The data electronics box shall continue to function nominally during an eclipse so long as power is provided to the operational bus, within the limits of section 3.27. When no regulated power is provided from the operational power bus, the data electronics box shall be unpowered (and inactive).

#### 3.14.1.11 **Safety/Health Monitoring**

The data electronics box shall provide the PCM telemetry system with a three bit status word, defined as Bi-level Type A telemetry. This interface shall provide the following safety/health information:

Command error detected  
Internal error detected  
Imaging mode (Yes/No)

Duplicates of this data will be provided in the MDL ancillary data packets.

#### 3.14.1.12 **Telemetry Downlink**

The SXI data electronics box shall provide interface to the MDL interface, and shall control the supply and content of the information to this interface.

#### 3.14.1.13 **Analog Housekeeping Data**

The data electronics box shall provide an internal subsystem for multiplexing internal analog signals in to the image data A/D converter. Conversion of this data shall be under data electronics box control, and shall not interfere with conversion of the solar image data.

#### 3.14.1.14 **Digital Status**

The data electronics box shall interface to the appropriate SXI subsystems in order to obtain status of all commandable subsystems.

#### 3.14.2 **Timing Requirements**

The data electronics box shall provide capability for timing the parameters given below.

##### 3.14.2.1 **Exposure Duration**

The data electronics box shall provide for selectable durations of an image exposure from 1ms to eight seconds, with a resolution of 1 ms.

##### 3.14.2.2 **Internal Clock**

The data electronics box shall maintain an internal clock for time-tagging image data. The elapsed time can be altered by ground command to a resolution of 1 sec.

##### 3.14.2.3 **On-board Image Storage Time**

The time that the images stored in the imaging detector before digitization, shall be minimized in order to minimize individual pixel response to discrete high energy events.

#### 3.14.3 **Motor Control Electronics**

The data electronics box shall provide control electronics for the filter wheel motor.

##### 3.14.3.1 **Filter Wheel Position**

The control electronics shall provide absolute knowledge of the final position of the filter wheel. The position of the filter wheel shall be controllable by the data subsystem.

##### 3.14.3.2 **Bi-directional Filter Wheel Rotation**

The control electronics shall provide for bi-directional rotation of the filter wheel.

### 3.15

## **STRUCTURAL/MECHANICAL DESIGN REQUIREMENTS**

**3.15.1 Structural Strength**

SXI shall be designed to meet the structural strength program requirements specified in MSFC-HDBK-505A. Factors of safety for glass structures shall be specified in Table 3.15-1.

Glass Condition	Analysis Factor of Safety	Qualification Test Factor
Analysis Only	5.0	N/A
Bonds for Structural Glass	2.0	1.4

**Table 3.15-1 Glass Factors of Safety**

**3.15.1.1 Joints To Glass**

Structural joints which use adhesive bonds to glass shall be analyzed to A-basis strength properties using the specified material, configurations, processes and environments in which the bonded joints will be used.

**3.15.2 Deformation**

SXI shall not exceed its dynamic envelope, specified in the IRD, section 3.2.2.2, when subjected to the loads specified in sections 3.26.2.4.

**3.15.3 Non-Destructive Evaluation**

Non-Destructive evaluation for SXI composite structure shall follow the requirements of MSFC-STD-1249 and MSFC-STD-397.

**3.15.4 Natural Frequency**

The SXI telescope and electronic boxes, when supported at their normal mounting points, shall have a base frequency greater than 65 Hz.

**3.15.5 Focal Distance**

The instrument focal distance shall be maintained to  $\pm 0.001$  inches ( $\pm 0.002$ cm).

**3.15.6 Support Structures**

The total x-ray path obscuration for all support structures shall not exceed 10%.

**3.16 POINTING AND ALIGNMENT REQUIREMENTS**

**3.16.1 Alignment Reference**

SXI shall provide an optical alignment reference. SXI shall meet the interface alignment requirements specified in section 3.1.1.4 of the IRD.

**3.16.2 Optical Axis Alignment to the GOES**

The alignment reference shall permit bore sighting the SXI optical axis to the GOES XRS alignment reference to within 30 arc-sec.

**3.16.3 Mirror Assembly/HASS Co-Alignment**

The optical axis of the HASS shall be aligned to the optical axis of the telescope to within  $\pm 2.0$  arc-min.

**3.16.3.1 Mirror Assembly/HASS Alignment Long Term Stability**

The alignment of the optical axis of the HASS to the optical axis of the telescope shall not vary by more than 10 arc-sec across the operating temperature range of SXI.

### 3.16.3.2 **Mirror Assembly/HASS Alignment Short-term Stability**

The alignment of the optical axis of the HASS to the optical axis of the telescope shall not vary by more than 5 arc-sec while the SXI is in thermal equilibrium of  $\pm 2^{\circ}\text{C}$ .

### 3.16.4 **Optical Axis Perpendicularity**

The focal plane detector shall be perpendicular to the optical axis to within 60 arc-seconds. The perpendicularity of the mating surfaces on the interface pads of the mounting ring to the plane defined by the optical axis shall be within 60 arcseconds.

### 3.16.5 **Image Centering**

The instrument shall maintain the optical axis centered on the focal plane detector to within  $\pm 10$  arc-sec.

### 3.16.6 **CCD Alignment**

The lines of the CCD shall be perpendicular to the SXI telescope mounting plane to within  $.2^{\circ}$ .

### 3.16.7 **Instrument Pointing**

The absolute pointing errors contributed by the SXI instrument to the overall pointing budget shall not exceed 2.0arcmin East-West, 2.0arcmin North-South, and 0.5 deg LOS (line-of-sight rotation) with respect to the solar /Earth-Equatorial Reference Axes. The error budget distributing the above values is given below.

#### 3.16.7.1 **Instrument Pointing and Misalignment and Uncertainty**

The absolute pointing errors contributed by instrument pointing misalignment and mechanical uncertainties shall not exceed 30arcsec. The absolute pointing errors contributed by centration errors due to mechanical tolerances shall be less than TBD arcsec.

#### 3.16.7.2 **Launch Shifts**

The absolute pointing errors contributed by any permanent shift in alignment due to the launch vibration environment shall not exceed 30arcsec.

#### 3.16.7.3 **Thermal Shifts**

The absolute pointing errors contributed by any permanent shift in alignment due to variations arising from the expected seasonal and diurnal thermal environments shall not exceed 30arcsec.

#### 3.16.7.4 **Graphite/Epoxy Outgassing**

The absolute pointing errors contributed by any permanent shift in alignment due to the graphite/epoxy optical bench outgassing shall not exceed TBD arcsec.

## 3.17 **ELECTRICAL REQUIREMENTS**

### 3.17.1 **Survival Power Budget**

Survival power for SXI during preorbital and eclipse operation shall not exceed 11.0W.

### 3.17.2 **Operational Power Budget**

The total power consumption for SXI, including the HASS and the EUV spectrometer, shall be less than 42W average. The total power consumption of SXI for a limited duration event, upon ground command, may exceed 42W average.

### 3.17.3 **HASS Power**

The HASS shall be supplied low voltage power from the power electronics box in accordance with Table 3.17-1.

Voltage Supplied	Maximum Current Supplied
+20V	35 mA
-20V	35 mA
+5V	25 mA

**Table 3.17-1 HASS Power Characteristics**

**3.17.4 Heater Power**

All power for survival heaters shall be provided by the heater I/F to the power bus interfacing to the GOES spacecraft.

**3.17.4.1 Survival Heater Power**

SXI shall distribute 11 W of survival heater power drawn from the survival power bus, to the optical bench, the power electronics box and the data electronics box.

**3.17.4.2 Operational Heater Power**

SXI operational heater power shall be drawn from the operational power bus and be distributed to the optical bench.

**3.18 THERMAL REQUIREMENTS**

SXI shall provide a Thermal Control Subsystem (TCS) which shall maintain all SXI subsystem, component, and interface temperatures within specified requirements, as defined in this section, during the on-orbit phases. The on-orbit phases include the stowed, deployment, non-operating, operating, and safemode configurations. In addition, the TCS design shall be based on worst case orbital combinations of vehicle orientation, altitude, attitude, and beta angles. The TCS shall also be based on worst case parameters such as optical properties, interface conductances, MLI performance, power configuration, mission timeline and orbital heat rates.

**3.18.1 Thermal Distortions**

The maximum change in focal length due to thermal distortions shall be no more than TBD in. during image acquisition mode, which corresponds to a TBD change in temperature of the optical bench assembly.

The focal point in the plane of the sensor shall not deviate more than TBD in. from the center of the sensor due to thermal distortions during image acquisition mode. This corresponds to a TBD change in temperature of the SXI telescope.

Thermal distortions in the mirror shall be no more than TBD in. in the radial direction and TBD in. in the longitudinal direction, which corresponds to a TBD change in temperature of the mirror.

**3.18.2 Orbital Temperature Limits**

SXI shall maintain its components temperatures within the limits specified in Table 3.18-1, while on orbit. Interface temperatures are given as the temperature on the SXI side of the interface.



Component	Operating Min/Max °C	Non-operating Min/Max °C
Telescope Mount I/F	TBD	TBD
Mirror Assy	-10/20	-40/30
Filter Wheel Motor	-25/50	-40/66
HVPS Assy	-40/40	-55/50
SXI Data Electronics Box Assy	-40/40	-55/50
SXI Power Electronics Box Assy	-40/40	-55/50
HASS Electronics	-40/40	-50/40
Camera Electronics	-55/21	-65/21
HASS Sensor Head	-10/40	-50/40
EUV Spectrometer	-40/40	-55/50
Prefilters	TBD	TBD
MCP	>2	-20/40
CCD		

**Table 3.18-1 Component Temperature Ranges**

**3.18.3 Image Quality**

SXI thermal and structural design shall maintain the SXI image quality within specification for any time-of-day and any season of the year, excluding eclipse periods.

**3.18.4 Sizing of Heaters**

SXI shall provide heaters which are sized for minimum supply voltage operation.

**3.18.5 Electronic Dissipations**

The TCS shall be designed to maintain temperature limits with the electrical dissipations given in Table 3.18.2. These dissipations represent minimum and maximum estimates and encompass all operating conditions while on-orbit. These values do not include dissipations provided by heaters.

Component	Minimum (watts)	Nominal (watts)	Maximum (watts)
CCD Electronics	0.4	0.5	0.55
HVPS	4	6.5	7.2
Filter Wheel Motor -continuous	0	0.25	0.17
20 sec/60 sec		2.5 (0.83)	0.83
SXI Power (Box1)	6.2	7.75	8.6
SXI Data (Box2)	13.2	16.5	18.2
HASS Electronics	0.64	0.8	0.88
<b>Totals</b>	<b>24.4</b>	<b>32</b>	<b>36.4</b>

**Table 3.18-2 Electrical Dissipation**

**3.18.6 MCP Heater Design**

The detector stack shall be provided a heater to maintain the MCP temperature above 0°C. The capability to remove power from the heater shall be provided. The capability to change the heater dissipation without changing the heater element itself shall be provided.

### 3.19 DATA MANAGEMENT SUBSYSTEM REQUIREMENTS

#### 3.19.1 Acceptable Data Quality

SXI data format shall be designed to permit detection of transmission errors.

#### 3.19.2 Frequency Stability

The short term frequency stability of all data transmitted to the MDL shall be at least TBD. The long term frequency stability of all data transmitted to the MDL shall be at least TBD.

#### 3.19.3 Transition Density

The SXI data shall be Manchester encoded to provide a guaranteed transition at the center of every bit. The fill pattern transmitted between CCSDS Transfer Frames shall consist of an alternating pattern of 0's and 1's in order to maintain phase-lock.

#### 3.19.4 Time Tagging

SXI data packets shall be time-tagged to a resolution of at least 1 millisecond.

A synchronizing data packet shall be produced and provided to the MDL (to be provided to the ground), indicating the time of the initiation of the x-ray image integration. This packet shall be available to the MDL with a maximum uncertainty of one millisecond between reception of the packet, by the MDL and the actual image integration.

#### 3.19.5 Eclipse Data

There is no requirement for data during eclipse periods, when the SXI is commanded "off". However, SXI shall make provisions for passive monitoring of temperatures by the GOES PCM telemetry system, by inclusion of thermistors in compliance with the conditioning circuit provided by GOES, as described in the IRD section 3.13.4.3. Thermistors shall be located on the following:

Mirror Assembly  
CCD Assembly  
Power Electronics  
Data Electronics

#### 3.19.6 Ground Controller Operational Health Data

The Data Management Subsystem shall provide an interface to the GOES PCM telemetry stream to give operational safety/health data to the ground controllers at SOCC. This data shall include:

- input current over the operational power bus
- temperatures of the mirror, detector, and electronics
- error status
- internal voltage references

#### 3.19.7 Data Frequency

Image data frequency shall be controlled by ground commands. Housekeeping and ancillary data shall be sent to the ground at least once per minute when SXI is not transmitting images.

#### 3.19.8 Data Content

Each image shall be accompanied by all the information necessary to reconstruct the image on the ground, including all free imaging parameters.

### 3.19.9 **Data Format**

SXI image, housekeeping, and diagnostic data shall be formatted as CCSDS packets, per CCSDS 102.0-B-2 "Packet Telemetry Blue Book." The length of each CCSDS Transfer Frame shall be a fixed length.

### 3.19.10 **Continuous Data Production**

The Data Management Subsystem shall transmit filler data when a CCSDS packet is not ready for transmission.

### 3.19.11 **Transfer Frame Synchronization**

Transfer Frame synchronization within the data stream shall be maintained by preceding each CCSDS Transfer Frame with the 32-bit CCSDS synchronization marker.

## 3.20 **SOFTWARE REQUIREMENTS**

System level flight and EGSE software requirements are defined herein. SXI shall meet the detailed software requirements specified in MSFC-SPEC-2112.

### 3.20.1 **Software Standards**

SXI flight software shall be developed in accordance with MD18075.1, satisfying the documentation intent of NASA-STD-2100-91. Detailed development standards shall be given in MSFC-PLAN-2111.

### 3.20.2 **Flight Software Requirements**

Flight software shall be written to operate the SXI micro processor. This software shall be stored in Read Only Memory (ROM) devices, and will not be dynamically changeable. Configuration tables for control or selection of dynamic parameters shall be provided both in ROM and Random Access Memory (RAM), to provide imaging sequencing information.

Flight software shall perform monitoring, control of the SXI onboard functions, data acquisition and formatting, and coordination of communications between the on-board operations and ground control through the GOES/SXI command interfaces.

#### 3.20.2.1 **Program Language**

Flight software shall be developed in ANSI C, with the use of assembly permitted where required for execution speed, compactness of code, or ease of coding.

#### 3.20.2.2 **Design Requirements**

The following define the design requirements for the SXI flight software.

##### 3.20.2.2.1 **Timing Requirements**

The timing characteristics of the SXI flight software shall be such that:

- 1) No uplinked commands are overwritten
- 2) The uncertainty in the time stamp applied to any software or hardware activity is  $\leq 1$  msec.

##### 3.20.2.2.2 **Operational Maintenance**

The flight software shall be stored in dynamically unalterable ROM. No alterations of flight software after creation of the flight ROM's shall be allowed.

##### 3.20.2.3 **Interface Requirements**

All interface requirements for flight software are internal to the SXI instrument. GOES interfaces are handled via the internal SXI subsystems. These interfaces are described in the following sections.

### 3.20.2.3.1 Hardware to Software Interfaces

All hardware interfaces are memory mapped. Control of internal subsystems shall be accomplished by writing designated bit patterns to memory-mapped addresses in the third memory page. Data/status from internal subsystems shall be accomplished by reading from memory-mapped addresses in the third memory page.

#### 3.20.2.3.1.1 Software to Software Interfaces

The SXI flight software does not interface to any other software.

### 3.20.2.4 Functional/Performance Requirements

The flight software shall provide the overall management and control of the SXI operational flight hardware and subsystems for the life of its mission. The flight software shall provide the initialization of the SXI hardware upon power-up, control image acquisition, readout the sensor data, EUV data, and housekeeping data, respond to commands, and format data for downlink to the ground. The following subsections contain specific functional and performance requirements for SXI flight software.

#### 3.20.2.4.1 SXI Initialization

The flight software shall be operational as defined in section 3.2. Upon power-up, the flight software shall initialize all SXI operational subsystems, determine health and status, and format and transmit initialization results.

#### 3.20.2.4.2 Command Processing

All commands to SXI flight software from the ground shall be received in the memory-mapped GOES interface. The flight software shall have the capability to receive, interpret, distribute, execute, and store commands and partial commands.

#### 3.20.2.4.3 Data Processing

The SXI flight software shall have the ability to capture data from all electronics subsystems, including the x-ray image data stored in RAM, the EUV data converted by the analog housekeeping system, and the sensor data. The following processing capabilities shall be provided.

- CCSDS Packet Transfer Frame Formation
- Image Intensity Statistics Calculations
- Detection of Potential Solar Flare Sites
- Downlink of Data from Specified CCD Regions

#### 3.20.2.4.4 Monitoring

SXI flight software shall provide the capability to monitor health status and report the health status data for downlink via the MDL, and PCM telemetry. This shall include:

- Monitoring of critical parameters during imaging
- Detailed monitoring of all parameters during diagnostics
- Determination of the status of all commandable subsystems

Subsystems/functions monitored by flight software shall be:

- Filter wheel position
- Time elapsed (via SXI elapsed time timer)
- Temperatures, currents, and voltages of SXI components
- Activation of the vacuum box door actuator and open/closed sensor status

#### 3.20.2.4.5 Control

SXI flight software shall control data collection, and hardware configurations. This shall be accomplished by writing command patterns to the SXI memory map. Data collection capability

shall include housekeeping, EUV, sun sensor, and x-ray image data. configuration information shall include filter-wheel location and rotation direction, HVPS programmed voltages, vacuum box door status, and power system discretes.

### 3.20.2.5 System Environment

The flight software shall be designed to operate with a single Analog Devices ADSP2100A operated at 6.144 MHz.

SXI flight software shall function when provided the following resources:

- 16k x 24 Words ROM (Program Instructions)
- 16k x 24 Words ROM (Program Data)
- 16k x 16 Words RAM (Page 1)
- 16k x 16 Words RAM (Page 2)
- 16k x 16 Words Memory-Mapped subsystems (Page 3)

Note: 1k x 16 locations of Page 1, Page 2 and Page 3 are configured as shared address space.

### 3.20.2.6 Special Considerations

Command patterns shall be selected to decrease the likelihood of SEU-induced upsets converting routine commands into mission-critical commands, and vice versa. A mission-critical command is defined as any command that, if executed at an inappropriate time, could cause degradation of the SXI system or damage to ground personnel.

### 3.20.3 EGSE Software

EGSE software shall be written to operate the SXI electrical ground support equipment. The EGSE software shall be used for testing/integrating flight software and hardware in simulated operational environments. The EGSE software shall provide the required simulations of the functions, timing, and other characteristics of all SXI interfaces and dynamics which effect flight hardware or software.

In addition to simulations, the EGSE software shall provide for data collection and post-processing functions to aid in evaluation of the flight hardware and software under test.

#### 3.20.3.1 Modification Consideration

The SXI software shall not be designed to preclude future modifications as the flight hardware and software, and the EGSE develop

#### 3.20.3.2 Program Languages

The use of assembly language shall be permitted where required for execution speed or compactness of code. Commercial Off The Shelf (COTS) software or reusable MSFC software shall be permitted and shall not be limited to C/C++ development, provided the code is executable with the developed code.

#### 3.20.3.3 Design Requirements

##### 3.20.3.3.1 Sizing and Timing Requirements

The EGSE software shall be designed to meet all functional requirements when executing from the EGSE computer system, as defined in section 3.20.3.5

##### 3.20.3.3.2 Interface Requirements

The EGSE software shall be designed to meet and simulate all data processing interfaces of the SXI/GOES interfaces.

### 3.20.3.3.3 Hardware to Software Interfaces

The EGSE software shall interface to the sensor and GOES simulators, via the data acquisition hardware. In addition, the EGSE software shall interface with video display, data entry, communication peripheral, and mass storage devices.

EGSE software shall provide the capability to control all interfaced hardware, providing the protocol of the function that is being simulated or controlled.

### 3.20.3.3.4 Software to Software Interfaces

The EGSE shall interface to other software packages, such as statistical analysis packages, etc., by providing inputs/output of SXI and EGSE data in compatible formats.

### 3.20.3.3.5 External Interface Requirements

The EGSE shall interface with the Space Systems/Loral ground support equipment via the communications requirements of the IRD, section 3.4.3. The EGSE software shall control this interface, including the defined data exchange protocol.

Additional external interfaces shall be facilitated via a standard telephone modem (9600 baud V42.bis), for remote data exchange. The EGSE software shall control this interface, and data exchange via this interface, when the EGSE software is not performing simulations or data analysis.

### 3.20.3.4 Functional/Performance Requirements

The EGSE software shall be capable of performing the data capture, storage, processing and data display functions of experiment checkout equipment.

The EGSE software shall:

- 1) provide executive command/control functions for the EGSE user;
- 2) Provide display functions for EGSE control, SXI control, and SXI data, including the ability to display/magnify any arbitrary region of the CCD display;
- 3) Provide control and protocol simulation for EGSE GOES interface simulators, EUV and sunsensor simulators, and the x-ray imaging system simulator;
- 4) provide telemetry, command, and data processing functions compatible with the formats required by or produced by the flight software;
- 5) provide the capability to normalize pixel data based upon calibration data provided on floppy disks;
- 6) provide test evaluation routines.

### 3.20.3.4.1 Analysis Packages

The EGSE software shall provide COTS packages for calculating pixels statistics such as deviations, mean, rms and peak deviations across a frame.

### 3.20.3.5 System Environment

The EGSE software shall be designed to meet all functional requirements when executed from a system consisting of a single 80486 processor, with an ISA bus structure, 16 MBytes of RAM, and the MS-DOS 5.0 (or later) operating system. A 9600 baud V42.bis internal modem is included.

### 3.20.3.6 Special Considerations

The EGSE software shall be designed and implemented to protect against the accidental issue of mission-critical SXI commands.

### 3.21 PHYSICAL REQUIREMENTS

SXI shall meet the physical envelope, mass characteristics, and mounting requirements specified in the IRD.

#### 3.21.1 Packaging

SXI shall consist of a telescope assembly mounted to the Instrument Mounting Panel (IMP) of the XRP platform of the GOES spacecraft solar array assembly and up to three electronics assemblies (one containing HASS electronics) all mounted to the yoke of the GOES spacecraft solar array assembly. The physical interfaces shall be as specified in the IRD, section 3.1.

#### 3.21.2 Telescope Envelope

The telescope shall be packaged within the three dimensional envelope specified in the IRD, section 3.1.1. Actual packaging shall allow incorporation of any thermal blankets required by the thermal design.

#### 3.21.3 Electronics Boxes Envelopes

The electronics boxes and HASS electronics shall be packaged within the envelope specified in the IRD section 3.1.1.

#### 3.21.4 HASS Dimensions

The HASS shall be packaged per NAS8-39041 Attachment J.

#### 3.21.5 Mass

The maximum mass of the SXI system shall be as shown in Table 3.21-1.

Component	Maximum Mass
SXI Telescope	34.6 lb (15.7 kg)
Electronics Boxes (3)	36.2 lb (16.4 kg)
Total SXI System	70.8 lb (32.1 kg)

Table 3.21-1 Maximum Mass

#### 3.21.6 Center of Gravity

The SXI center of gravity shall be as specified in the IRD, section 3.2.2.4.

#### 3.21.7 Moments of Inertia

The SXI moments of inertia shall be as specified in the IRD, section 3.2.2.4.

#### 3.21.8 Coordinate Systems

The SXI telescope and SXI electronics boxes coordinate systems shall be as specified in the IRD, section 3.1.

### 3.22 GROUND SUPPORT EQUIPMENT REQUIREMENTS

#### 3.22.1 General

SXI shall provide any ground support equipment that is required to support final assembly, checkout, calibration, shipping, storage, integration or operation of the instrument. The physical configuration and power and data interfaces of SXI GSE used by or in conjunction with the spacecraft contractor shall be as specified in the IRD.

### 3.22.2 **Electrical Ground Support Equipment**

SXI shall provide EGSE for operating and testing the instrument and electronics assemblies, in both a stand alone and the GOES integrated configurations. The EGSE shall provide for all inputs, controls, and monitors necessary for operating and testing the instrument. The EGSE shall provide a capability for ingesting, processing and displaying the SXI data from the spacecraft MDL link during tests after spacecraft integration, and the capability of powering any stimulus required to simulate data inputs.

#### 3.22.2.1 **EGSE ADP Equipment**

The EGSE shall provide ADP equipment to capture, store, process and display SXI data and to provide a user interface.

##### 3.22.2.1.1 **Data Capture and Storage**

The EGSE ADP equipment shall be capable of capture and storage of all SXI data. Prior to SXI integration, this shall be provided by use of the EGSE spacecraft simulator. After integration, SXI MDL data shall be provided to the EGSE, following RF demodulation and bit synchronization. The interface to the SS/L GSE providing this function is detailed in the IRD.

Supported data input/output methods include:

- storage for at least 100 images
- storage retrieval via MS-DOS compatible floppy disks
- laser printer capable of 300X300 dpi resolution
- 9600 baud modem for use with standard telephone lines

##### 3.22.2.1.2 **Data Display Capability**

The EGSE ADP equipment shall be capable of representing the SXI image data using VGA computer monitor output capable of at least the 512 by 512 display.

##### 3.22.2.1.3 **Data Transmission**

The EGSE ADP equipment shall include a modem capable of transmitting full-frame digital image data and header data using error correction coding at 9600 baud via standard telephone line.

#### 3.22.2.2 **EGSE Simulators**

The EGSE shall include a GOES interface simulator as defined below.

##### 3.22.2.2.1 **GOES Interface Simulator**

The GOES interface simulator shall be used for testing prior to SXI/GOES integration.

###### 3.22.2.2.1.1 **MDL Interface Simulation**

The EGSE shall provide an interface simulating the GOES MDL. This interface shall receive data from the SXI and shall pass the data to the EGSE ADP equipment.

###### 3.22.2.2.1.2 **Command Interface Simulation**

The EGSE shall provide an interface simulating the GOES proportional command number 36. This interface shall receive data from the ADP equipment, and pass data to SXI, in simulation of the action of the GOES spacecraft.

###### 3.22.2.2.1.3 **PCM System Interface Simulation**

The EGSE shall provide interfaces simulating the interfaces between the SXI and the GOES PCM telemetry system. This consists of data defined in 3.14.1.2.

###### 3.22.2.2.1.4 **Power System Interface Simulator**

The EGSE shall provide interfaces simulating the interface between the SXI power system and the GOES power busses.



### 3.22.2.3 EGSE Power

The EGSE shall provide power to the SXI vacuum pump and calibration sources which require external power.

### 3.22.2.4 EGSE Software

The EGSE shall provide software to issue all SXI commands, and analyze SXI data as defined in 3.22.2.1.2, Data Processing Capability.

### 3.22.2.5 EGSE Interfaces

The EGSE shall provide an interface to the GOES GSE to provide MDL data to the EGSE. This interface shall be defined in the IRD, section 3.4.3.

## 3.22.3 Mechanical Ground Support Equipment

SXI shall provide MGSE which consists of an aperture plate cover, a vacuum servicer, a dry gas purge system, and a means to cool the CCD.

### 3.22.3.1 Aperture Plate Cover

An aperture plate cover shall be provided for the instrument to protect the instrument prefilters from damage during ground operations. The plate shall be removed prior to flight.

### 3.22.3.2 Vacuum Servicer

A vacuum pumping station shall be provided to evacuate the detector housing for ground operations. The pumping station shall be oil and contamination free and be able to pump the detector housing down to at least  $1 \times 10^{-6}$  torr.

### 3.22.3.3 Dry Gas Purge System

A dry gas purge system shall be provided to protect the instrument from contaminants during storage, shipment, after integration, and anytime the telescope assembly is not in testing. The purge shall be removed as close to launch as possible. Dry gas shall be prepared using MSFC-PROC-404B.

## 3.23 SAFETY AND MISSION ASSURANCE REQUIREMENTS

### 3.23.1 Quality Assurance

SXI quality assurance requirements shall be in accordance with MSFC-PLAN-2241.

### 3.23.2 Reliability

SXI reliability requirements shall be in accordance with MSFC-PLAN-2241.

#### 3.23.2.1 Useful Life and Shelf Life

The SXI instrument equipment shall be designed to meet the requirements of this specification during the operational life specified in 3.2.3, following terrestrial storage under controlled conditions (shelf life) of up to five years.

### 3.23.3 Safety

SXI safety requirements shall be in accordance with MSFC-PLAN-2241.

### 3.23.4 Software Quality Assurance

SXI software quality assurance requirements shall be in accordance with MSFC-PLAN-1975.

### 3.24 MAINTAINABILITY REQUIREMENTS

#### 3.24.1 Filter Changeout

SXI shall provide access to the filter wheel, in order to change out and verify filters, without affecting mirror alignment. The high voltage cables shall be capable of being disconnected from the HVPS housing.

#### 3.24.2 Prefilter Changeout

SXI shall provide access to the telescope prefilters for changeout, without affecting mirror alignment.

3.25 Deleted

### 3.26 ENVIRONMENTAL REQUIREMENTS

SXI shall be designed to meet its specified performance requirements prior to, during and after being exposed to the environments specified herein.

#### 3.26.1 Prelaunch

SXI shall be capable of meeting the requirements in this specification after exposure to any of the following conditions during the prelaunch period at both the integration and launch sites:

- Pressure: TBD
- Thermal: TBD
- Humidity: min 30%  
max 60%

#### 3.26.2 Launch / Ascent

SXI shall be capable of meeting the requirements in this specification after exposure to the following conditions:

- Pressure: Increasing: 14mm Hg/sec  
Decreasing: 59.9mm Hg/sec
- Thermal: TBD
- Humidity: min 30%  
max 60%
- Vibration: per 3.26.2.2 and 3.26.2.3
- Acceleration: per 3.26.2.4
- Acoustic Noise: per 3.26.2.1
- Shock: per 3.26.2.5

##### 3.26.2.1 Acoustic Noise

SXI shall withstand the acceptance acoustic noise levels specified in Figure 17 of the IRD.

##### 3.26.2.2 Sine Vibration

SXI shall withstand the sine vibration levels specified in Figure 14 of the IRD.

##### 3.26.2.3 Random Vibration

SXI shall withstand the acceptance random vibration levels specified in Figure 15 of the IRD.

##### 3.26.2.4 Acceleration

SXI shall withstand loads as specified in section 3.2.2.3 of the IRD.

##### 3.26.2.5 Shock

SXI shall withstand the shock loads specified in Figure 16 of the IRD.

### 3.26.3 On-Orbit

SXI shall be capable of meeting the requirements in this specification while being exposed and after exposure to the following conditions:

-Pressure:	$1 \times 10^{-10}$ torr, steady state
-Earth Radiation:	$237 \pm 36 \text{ W/m}^2$ ( $75 \pm 12 \text{ Btu/hr} \cdot \text{ft}^2$ )
-Earth Albedo:	$.3 \pm .12$
-Solar Radiation:	$1353 \pm 88 \text{ W/m}^2$ ( $429 \pm 28 \text{ Btu/hr} \cdot \text{ft}^2$ )
-Radiation:	See 3.26.3.1
-Micrometeoroids:	See 3.26.3.2

#### 3.26.3.1 Radiation Environment

Adequate radiation protection shall be provided by means of local shielding and/or satellite structure to assure reliable performance of all parts for the lifetime of the instrument. The satellite radiation environment is defined in X-601-84-3. SXI components shall withstand a total dose of 30K-rads.

#### 3.26.3.2 Micrometeoroid Environment

SXI flight hardware shall be designed to have a minimum probability of 0.95% of experiencing no critical failure due to meteoroid impacts for an extended mission life of 3 years. The meteoroid environment shall be as specified in SSP30425.

#### 3.26.3.3 Shock

SXI shall be designed to withstand the shock loads specified in Figure 16 of the IRD.

#### 3.26.4 Ground Handling, Storage and Transportation Environment

SXI shall be capable of meeting the requirements of this specification after exposure to the following conditions, when properly prepared for shipment/storage before exposure:

-Pressure:	12psia
-Thermal:	min: $-1^\circ\text{C}$ max: $43^\circ\text{C}$
-Humidity:	min 30% max 60%
-Shock:	See 3.26.4.1
-Vibration:	See 3.26.4.2

#### 3.26.4.1 Shock

Ground handling, storage and transportation shock loads shall not exceed the SXI shock design criteria specified in 3.26.3.3.

#### 3.26.4.2 Vibration

Ground handling, storage and transportation vibrations shall be below the SXI vibration design criteria specified in 3.26.2.2 and 3.26.2.3.

### 3.27 TRANSPORTATION AND STORAGE REQUIREMENTS

SXI shall provide any special transporters, servicing, and handling equipment required to support the flight hardware and/or the GSE. This equipment is defined below. Handling, packaging and transportation shall be in accordance with NHB6000.1C.

#### 3.27.1 Shipping Container(s)

The shipping container(s) shall protect SXI and associated GSE during shipping and storage.

### 3.27.1.1 Loads

The shipping container shall not be damaged when subjected to the following loads:

Truck or Air ride Trailer:	Fore/Aft $\pm 2.0g$
	Lateral $\pm 2.0g$
	Vertical $+3.5g, -1.5g$

These loads occur independently in three directions except for gravity.

### 3.27.1.2 Environment

The shipping container for the flight unit shall provide an inert gas purge or charge to maintain a clean environment. The gas shall be prepared using MSFC-PROC-404 to ensure cleanliness and low water vapor content.

## 3.28 DESIGN AND CONSTRUCTION REQUIREMENTS

### 3.28.1 Selection of Specifications and Standards

Specifications and standards for design of SXI are called out in this specification. Additional specifications and standards shall be selected from MM8070.2.

### 3.28.2 Design Drawings

Engineering drawings, electrical diagrams, schematics and associated lists for in-house drawings shall be in accordance with MSFC-STD-555. Contractor drawings shall be in accordance with MIL-STD-100E.

### 3.28.3 Units

All design, construction, and testing of SXI shall be in English Units, with the exception of the mirror and camera assembly, which will be designed and built in Metric Units.

### 3.28.4 Electrical Design Requirements

#### 3.28.4.1 Electrical, Electronic and Electromechanical (EEE) Parts

##### 3.28.4.1.1 EEE Parts Selection

EEE parts, selection and screening shall conform to the requirements and guidelines contained in MIL-STD-975, Grade II minimum. Where necessary to meet SXI reliability requirements, class S, or screened Grade II parts shall be used. Grade II screening shall be in compliance with the MSFC Grade II+ designation as defined in MSFC-SPEC-1198.

##### 3.28.4.1.2 Nonstandard EEE Parts

Nonstandard parts, those not listed in MIL-STD-975 may be used when there is no standard part with a performance capability to satisfy the requirements or a standard part is not available. The screening requirements shall be in accordance with MSFC-SPEC-1198 and MSFC-STD-355.

##### 3.28.4.1.3 EEE Part Derating Criteria

The EEE parts derating shall be in accordance with the derating criteria of MIL-STD-975.

##### 3.28.4.1.4 EEE Parts Marking

Marking of electrical and electronic parts shall be in accordance with MIL-STD-1285.

### 3.28.4.2 Electrostatic Sensitivity

The SXI equipment design shall minimize energy storage due to differential charging by the selection of insulating materials or surfaces having a resistivity-thickness product of less than  $10^9 \text{ohm}\cdot\text{cm}^2$ .

#### 3.28.4.2 **Electrostatic Sensitivity**

The SXI equipment design shall minimize energy storage due to differential charging by the selection of insulating materials or surfaces having a resistivity-thickness product of less than  $10^9 \text{ohm}\cdot\text{cm}^2$ .

#### 3.28.4.3 **Crimped Connectors**

Electrical connectors using crimped connections and/or wire wrap connections shall be in accordance with NHB5300.4(3H) and MSC-JD-001. Electrical connections shall be tested per MSC-STD-781.

#### 3.28.4.4 **Soldering**

Soldered electrical connections shall be in accordance with NHB5300.4(3A-1).

#### 3.28.4.5 **Printed Circuits**

The design and documentation of printed wiring boards shall be in accordance with NHB5300.4(3K). Fabrication of printed wiring boards shall be in accordance with NHB5300.4(3I).

#### 3.28.4.6 **Conformal Coating**

Conformal coating and staking shall be in accordance with NHB5300.4(3J).

#### 3.28.4.7 **Cable and Wiring Harnesses**

Requirements for interconnecting cables, harnesses, and wiring shall be in accordance with MSFC-SPEC-494 or NHB5300.4(3G). (Identification of electrical harnesses shall be in accordance with MSFC-SPEC-708. All cables shall be tested per NHB5300.4(3G) paragraph 3G1401.

#### 3.28.4.8 **Electrical Grounding, Bonding and Isolation**

SXI shall meet the grounding, bonding, and isolation requirements of the IRD and also comply with the following requirements outlined in this paragraph. SXI structure and equipment mounting shall be electrically bonded to reduce spacecraft charging. Metal-to-metal bonding resistance shall be  $2.5\text{m}\Omega$  or less. Metal-to-nonmetal bonding resistance shall be less than  $1\text{ k}\Omega$ . All metalized surfaces of MLI blankets shall incorporate multiple ground tabs such that no point on the MLI blanket is more than one meter away from a ground tab. The MLI blanket-to-structure resistance shall be less than  $10\ \Omega$ .

#### 3.28.4.9 **Electrical Fault Protection**

Fuses or circuit breakers shall be provided to protect against current overload. SXI circuit protection shall be fused to a lower current than upstream devices. Wiring shall be sized to be compatible with upstream fusing.

#### 3.28.4.10 **Radiation Shielding**

SXI shall incorporate radiation shielding where required to limit total dose radiation exposure to within device limits. This shielding shall consist of tantalum, or other high-Z materials, applied directly to the case of sensitive components.

#### 3.28.4.11 **Shielding**

Individual circuit shielding shall be in accordance with NHB 5300.4(3G). Overall shields shall be in accordance with NHB 5300.4(3G).

#### 3.28.4.12 **Electromagnetic Compatibility**

**3.28.4.12.1 Radiated Emissions**

SXI equipment shall meet the radiated emission requirements of the IRD and tested in accordance with MIL-STD-462.

**3.28.4.12.2 Radiated Susceptibility**

SXI equipment shall meet the radiated susceptibility requirements of Table 3.28-1 and tested in accordance with MIL-STD-462.

Frequency Range	Level
14 kHz - 2 GHz	2 V/m
2 GHz - 12 GHz	5 V/m

**Table 3.28-1 Radiated Susceptibility Requirements**

The specific frequencies and amplitudes included are shown in Table 3.28-2.

Frequency	Level
1.694 GHz	15 V/m (CDA Xmitter)
2.209086 GHz	10V/m (DSN Xmitter)
2.208586 GHz	10V/m (DSN Xmitter)

**Table 3.28-2 Radiated Susceptibility Requirements for Discrete Frequencies**

**3.28.4.12.3 Conducted Emissions and Susceptibility**

Equipment which have power, telemetry, command data, and other signals which interface the GOES spacecraft shall meet the conducted emission and conducted susceptibility requirements of the IRD, paragraphs 3.2.3.9.1 and 3.2.3.9.2 respectively and tested in accordance with TBD. Equipment which do not have power interfaces with the GOES spacecraft but with other SXI equipment only shall meet the conducted emission limits as indicated in Table 3.28-3, and shall be tested in accordance with the test method of TBD.

Applicable Power Line	Emission Limit
±52V	200mV
20V	200mV
5V	200mV

**Table 3.28-3 Conducted Emission Limits**

**3.28.4.13 Coronal Suppression**

High voltage design shall be in accordance with the criteria specified in MSFC-STD-531.

**3.28.4.14 Radiation Resistance**

SXI EEE components shall be selected to make maximum use of devices tolerant to 30K-rads (Si). Devices less tolerant shall be spot-shielded to at least this level of effective resistance, not counting shielding from the electronics structure.

**3.28.4.15 Electrostatic Discharge**

Electrostatic discharge control shall be in accordance with MSFC-SPEC-1493. Maximum allowable charge buildup on optical bench structure shall be no greater than TBD v.

### 3.28.5 **Mechanical Fasteners**

Mechanical fasteners shall meet MSFC-STD-486, MSFC-STD-557, and MIL-STD-1515, where applicable.

### 3.28.6 **Adhesive Bonding**

Adhesive bonding shall be in accordance with MSFC-SPEC-445.

### 3.28.7 **Materials**

#### 3.28.7.1 **Materials and Processes**

All materials of construction shall meet the applicable requirements of MSFC-STD-506. All metallic materials used shall meet the requirements of MSFC-SPEC-522. Material selection shall be in accordance with MSFC-HDBK-527.

#### 3.28.7.2 **Material Properties**

Material properties for the metallic portion of the SXI structure shall be as defined in MIL-HDBK-5E. Material properties for the graphite epoxy composite structure shall follow the guidelines of MIL-HDBK-17B.

#### 3.28.7.3 **Magnetic Material Usage**

Magnetic material usage shall be minimized by design. Magnetic properties of SXI shall be specified in the IRD. The magnetic field of SXI equipment at a distance of one meter from the unit shall be less than 10 nanoteslas in each axis.

#### 3.28.7.4 **Outgassing/Offgassing**

All materials used in construction of SXI shall meet the thermal vacuum stability requirements of JSC-SP-R-0022.

#### 3.28.7.5 **Corrosion of Metal Parts**

All metallic materials used in structure, attachment hardware, and support bracketry shall meet the stress corrosion requirements of MSFC-SPEC-522.

#### 3.28.7.6 **Finishes**

Finishes shall be in accordance with MSFC-SPEC-250A. Surfaces of removable pins, sliding parts shall be finished such that there will be no galling of contacting surfaces.

#### 3.28.7.7 **Brazing**

Brazing shall be in accordance with MIL-B-7883B.

#### 3.28.7.8 **Flammability**

Materials used shall meet the flammability requirements of NHB8060.1.

### 3.28.8 **Assembly**

SXI shall be assembled in accordance with MSFC-PLAN-2252.

### 3.28.9 **Identification and Marking**

Each system component and higher levels of assembly shall be marked and serialized for identification in accordance with NHB5300.4(1D-2) and MMI 5300.12. Marking of electrical and electronic parts and equipment shall be in accordance with MSFC-STD-383, MIL-STD-130 and MSFC-HDBK-527. Marking for shipment and storage shall be to MIL-STD-129.

### 3.28.10 **Contamination Control**

SXI shall meet the contamination control requirements specified in MSFC-PLAN-2242.

### 3.28.11 **Configuration Management**

SXI requirements for baselining, controlling and providing necessary changes to baselined documents shall be in accordance with MMI8040.15.

### 3.29 **PERSONNEL AND TRAINING REQUIREMENTS**

Personnel that are not experienced in the assembly, adjustment, calibration, testing and handling of similar aerospace hardware shall receive adequate training before beginning such tasks.

### 3.30 **EXTERNAL INTERFACE REQUIREMENTS**

SXI shall provide interfaces to control the operation of the instrument including the activation of mechanisms, image acquisition and transmission to the ground, and the maintenance of the required thermal environment. SXI shall be designed to meet the interface requirements specified in the IRD.

#### 3.30.1 **EUV Spectrometer Interface**

SXI shall provide electrical power and a data interface for control and data readout of an EUV spectrometer.

##### 3.30.1.1 **EUV Spectrometer Power Interface**

SXI shall provide 0.5W of regulated power at 20V and 0.5W of regulated power at -20V. Each power line will be fused at 50mA. In addition, a common return line shall be provided.

##### 3.30.1.2 **EUV Spectrometer Control Interface**

SXI shall provide control of an EUV spectrometer via four digital control lines that shall cycle over the counter range of 0000 to 1111 (binary) in synchronization with the SXI data frames. The output characteristics of these control lines shall be compatible with a 54AC04 driver.

##### 3.30.1.3 **EUV Data Interface**

SXI shall read data from an EUV spectrometer via a single, two-line differential voltage. The maximum voltage on any one line shall be 10Vdc, and the minimum shall be -10Vdc.

##### 3.30.1.4 **EUV Physical Interface Characteristics**

The EUV voltage output, and power and data inputs, shall be carried over a cable to be provided by Space Systems/Loral. The interface connector in the EUV will meet Space Systems/Loral specifications. SXI shall provide pins for the EUV interface to SXI. The power, data, and voltage pins shall be contained in a single D subminiature connector.

#### 3.30.2 **Physical Interfaces**

SXI shall meet the physical interfaces specified in the IRD, section 3.1.

#### 3.30.3 **Mechanical Interfaces**

SXI shall meet the mechanical interfaces specified in the IRD, section 3.2.2.

#### 3.30.4 **Electrical Interfaces**

SXI shall meet the electrical interfaces specified in the IRD, section 3.2.3.



## 4.0 VERIFICATION

### 4.1 GENERAL

The verification program shall ensure that SXI will conform to the design and performance requirements specified in Section 3.0, and will be compatible with the GOES spacecraft.

### 4.2 VERIFICATION METHODS

Verification shall be accomplished by one or more of the following methods:

1. Test
  - a. Functional Test
  - b. Environmental Test
2. Analysis
3. Demonstration
4. Inspection
5. Validation of Records
6. Similarity
7. Review of Design Documentation

#### 4.2.1 Test

##### 4.2.1.1 Functional Tests

Functional testing is an individual or series of electrical or mechanical performance test(s) conducted on flight or flight configured hardware at conditions equal to or less than design specifications. The purpose is to establish that the hardware performs satisfactorily in accordance with design specifications.

##### 4.2.1.2 Environmental Tests

Environmental testing is an individual or series of test(s) conducted on flight or flight configured hardware to assure the flight hardware shall perform satisfactorily in its flight environment. Examples are vibration, acoustic, thermal vacuum, and EMC. Environmental testing may or may not be combined with functional testing depending on the objectives of the test. Functional testing will be accomplished before and after each performance prior to the next test/operation.

##### 4.2.2 Analysis

Verification by analysis is a process used in lieu of or in addition to testing to verify compliance to specification requirements. (e.g. stress, thermal, materials). The selected techniques may include systems engineering analysis, statistics and qualitative analysis, computer and hardware simulations, and analog modeling.

##### 4.2.3 Demonstration

Verification by demonstration is where actual demonstration techniques are used in conjunction with the requirements such as serviceability, accessibility, transportability, and human engineering features.

##### 4.2.4 Inspection

Verification by inspection is the physical evaluation of equipment and associated documentation to verify design features. Inspection is used to verify construction features, workmanship, dimensions and physical condition, such as cleanliness, surface finish and locking hardware.

#### 4.2.5 **Validation of Records**

Verification by validation of records is the process where manufacturing records are used at end-item acceptance to verify construction features and processes for flight hardware.

#### 4.2.6 **Similarity**

Verification by similarity is the process of assessing by review of prior test data or hardware configuration and application that the article is similar or identical in design and manufacturing process to another article that has previously been qualified to equivalent of more stringent specifications.

#### 4.2.7 **Review of Design Documentation**

Verification by review of design documentation is the process of reviewing the design against the requirements, which as stated may or may not contain specifics to be met by a test, analysis, etc. but must be present in the design. This method is used during the preliminary design and critical design reviews of the development phase, prior to having flight configured hardware.

### 4.3 **VERIFICATION PHASES**

#### 4.3.1 **Development**

Development Phase is the period during which a new program design is initiated and implemented up to manufacturing of flight hardware. Requirements verified during this phase will verify the new design approach and develop confidence in the ability of the design to accomplish mission objectives.

#### 4.3.2 **Qualification**

Qualification Phase is the period during which the flight hardware and / or software is verified to meet the performance and design requirements. Verifications during this phase are conducted on flight configured hardware at conditions normally more severe than acceptance conditions to establish that the hardware will perform satisfactorily in the flight environments with sufficient margin.

#### 4.3.3 **Acceptance**

Acceptance Phase is the period during which the deliverable flight end-item is shown to perform as design and performance requirements state and under conditions specified by the flight mission. Requirements verified during this phase will verify the flight hardware and / or software's ability to perform the mission for which it was designed.

#### 4.3.4 **Prelaunch**

Prelaunch Phase is the period which begins with the arrival of the flight hardware and software at the launch site and terminates at launch. Requirements verified during this phase are those which demand the integrated vehicle or carrier, and/or launch site facilities.

#### 4.3.5 **Flight**

Flight Phase is the period which begins at liftoff and continues through the length of the mission. Requirements verified during this phase, either totally or in part, are such that, without taking on unnecessary risk, flight environment conditions are necessary.

### 4.4 **VERIFICATION LEVELS**

Verification levels are those hardware levels used to identify discrete verification activities.

#### 4.4.1 **Component**

The component verification level is the level at which verifications are performed on an individual end item. Verification at this level is the first activity applied prior to being integrated with other components or into subsystems. SXI components include: the HVPS, the camera, the filter wheel, etc.

#### 4.4.2 **Subsystem**

The subsystem verification level is the level at which verifications are performed on two or more components, including inter-connecting cabling, that have been integrated into a functional subsystem. The subsystem verification level follows the component verification level. Verification of a subsystem can be performed during the development, qualification, or acceptance verification phases, and may include flight or flight configured hardware separately or in combination. SXI subsystems include the telescope, the electronics boxes, the thermal subsystem, the data management subsystem, etc.

#### 4.4.3 **System**

This verification level follows the subsystem level, and consists of subsystems and components, including interconnecting cabling that form the flight system. This level of verification includes system functional tests, interface checks and environmental test. SXI systems include: SXI, GSE, and shipping container.

#### 4.5 **VERIFICATION REQUIREMENTS MATRIX**

The Verification Requirements Matrix, found in Appendix A, indicates how each specification requirement of section 3.0 is verified by phase, method, and level.

#### 4.6 **VERIFICATION SOFTWARE**

The software used with GSE to verify performance of flight hardware shall be functionally tested and code verified before use with flight equipment.

#### 4.7 **VERIFICATION FACILITIES AND EQUIPMENT**

Existing facilities and equipment should be used to the extent possible. Maximum use of the same test equipment should be made for testing at multiple locations to assure uniformity of test results. All test equipment shall be verified prior to interfacing with flight hardware to ensure that no damage or degradation to flight hardware will be induced. Test software shall be validated/verified prior to use with flight hardware and software.

### 5.0 **PREPARATION, PACKAGING, AND SHIPMENT**

#### 5.1 **MAINTAINING CONTROLLED ENVIRONMENT**

Instrument equipment and materials sensitive to deterioration, contamination, or corrosion through exposure to air, moisture, or other elements during shipment shall be maintained in a controlled environment during shipping.

##### 5.1.1 **Maintaining Detector Housing**

The detector housing shall maintain pressure to between 2.5 and 5 psig or  $<1 \times 10^{-3}$  torr.

**5.2 PROTECTIVE COVERS**

Protective covers shall be applied to delicate mechanisms or materials and to apertures to prevent damage in normal handling.

**5.3 SHIPPING CONTAINERS**

SXI flight hardware shall be sealed in the certified shipping container.

**5.4 REMOVE BEFORE FLIGHT ITEMS**

Covers, seals, or other materials which are to remain on SXI after integration into the payload, but are not part of the flight configuration, shall be identified by a "Remove Before Flight" tag, of a conspicuous red color, and identified in the Acceptance Data Package.

**5.5 SPECIAL INSTRUCTIONS**

Warnings of special instructions for safe handling of equipment shall be prominently printed on the equipment or on a tag affixed to the equipment and on the equipment containers.

**5.6 SHIPPING**

Shipment shall be by government transport or accepted commercial means.

**EXAMPLE**

**APPENDIX A**  
**VERIFICATION REQUIREMENTS MATRIX**

**EXAMPLE**

**METHOD**

- 1.0 Test
  - 1.1 Functional
  - 1.2 Environmental
- 2.0 Analysis
- 3.0 Demonstration
- 4.0 Inspection
- 5.0 Validation of Records
- 6.0 Similarity
- 7.0 Review of Design Documentation

**LEVEL**

- a. Component
- b. Subsystem
- c. System

**PHASE**

- D Development
- Q Qualification
- A Acceptance
- P Prelaunch
- F Flight
- N/A Not Applicable

**EXAMPLE**

VERIFICATION REQUIREMENTS MATRIX

SECTION 3.0  PARA. NO.	VERIFICATION BY LEVEL AND METHOD						NOTES
	D	Q	PHASE			N/A	
			A	P	F		
3.0						X	
3.1						X	
3.1.1	7						
3.1.2			1.1bc, 4bc				
3.2						X	
3.2.1	2c						
3.2.2	2c						
3.2.3	2c						
3.2.4						X	
3.3						X	
3.3.1	2c		1.1c				
3.3.2	2c		1.1c				1
3.3.3	2c						
3.4	7		4a				
3.4.1	2a		1.1a				2
3.4.2	2a		1.1a				
3.4.3	2a		1.1a				
3.4.4			2b, 1a				
3.4.5	2a		1.1a				
3.4.6	7		5a				
3.4.7	2a	5a	5a				
3.4.8	2a		1.2a				
3.4.9	2a		5a				
3.4.10	7		4a,1.1c				
3.5	7						
3.5.1	2b						
3.5.2	2b	1.2b					
3.5.3	7						
3.5.3.1	2b						
3.6	7						
3.6.1	7,2b						
3.6.2	7		4a,5a				
3.6.2.1	2b						
3.7	7,2a						
3.7.1	7						
3.7.1.1	7		4b				
3.7.2	7,2a	1.1a	1.1a				
3.7.2.1	2a						

**VERIFICATION REQUIREMENTS MATRIX**

SECTION 3.0	VERIFICATION BY LEVEL AND METHOD						NOTES
	PARA. NO.	D	Q	PHASE A	P	F	
3.7.2.2	7,2a			1.1a			
3.7.3	7			4a			
3.7.3.1	2a						
3.7.3.2	2a						
3.7.3.3	2a	1.1a					
3.7.3.4	7			1.1a,1.1c			
3.7.3.5	7			1.1a,1.1c			
3.7.4				1.1a,1.1c			
3.7.5	2a			4a,1.1a			
3.8	7			4a			
3.8.1	2a			1.1a,1.1c			
3.8.2	2a			1.1a,1.1c			
3.8.3	2a			1.1a,1.1c			
3.8.4	2a						
3.8.5	2a						
3.8.6	7,2a						
3.8.7	2a						
3.9	7						
3.9.1	7			4a,1.1c			
3.9.1.1							X
3.9.1.1.1	2c			1.1c			
3.9.1.1.2							X
3.9.1.1.2.1	2a	1.1a		1.1a			
3.9.1.1.2.2	2a						
3.9.1.1.2.3	7			1.1c			
3.9.1.2							X
3.9.1.2.1	7,5a	5a		5a			
3.9.1.2.1.1							TBD
3.9.1.2.1.2							X
3.9.1.2.1.3							TBD
3.9.1.2.2	7	5a		5a			
3.9.1.2.3	7			5a			
3.9.1.2.4	7	1.1a		1.1ac,4a			
3.9.2	7,2b	4a		4a			
3.9.2.1	7						
3.9.2.1.1	7,2b						



VERIFICATION REQUIREMENTS MATRIX

SECTION 3.0	VERIFICATION BY LEVEL AND METHOD						NOTES
	D	Q	PHASE			N/A	
PARA. NO.			A	P	F		
3.9.2.2	7						
3.9.2.2.1	7		1.1b				
3.9.2.2.2	7,2a		4a				
3.9.2.2.3	7						
3.9.2.2.4	2a	1.2a	1.2a				
3.9.3	7		4a				
3.9.4							TBD
3.9.5	2b						
3.10							
3.10.1	7		4a				
3.10.2							TBD
3.11	7		4a				
3.11.1	7	1.1a	1.1a				
3.11.2	7	1.1a	1.1a				
3.11.3	7		4a				
3.11.4	7						
3.11.5	7	1.1a	1.1a				
3.11.6	7	1.1a	1.1a				
3.12	7		1.1a				
3.13	7		1.1c				
3.13.1	7	1.1a	1.1a,c				
3.13.1.1	7	1.1a	1.1a				
3.13.1.2							TBD
3.14	7		1.1c				
3.14.1						X	
3.14.1.1	2b		1.1c				
3.14.1.2			1.1c				
3.14.1.3			4b				
3.14.1.3.1			4b				

VERIFICATION REQUIREMENTS MATRIX

SECTION 3.0  PARA. NO.	VERIFICATION BY LEVEL AND METHOD						NOTES
	D	Q	PHASE			N/A	
			A	P	F		
3.14.1.4			4b				
3.14.1.5			4b,1.1c				
3.14.1.6			1.1bc				
3.14.1.7			1.1bc				
3.14.1.8			1.1b				
3.14.1.9			1.1b,c				
3.14.1.10	7		4b				
3.14.1.11	2b		1.1c,4b				
3.14.1.12			1.1b				
3.14.1.13	7						
3.14.1.14	7		1.1b				
3.14.1.15	7		1.1b				
3.14.2	7						
3.14.2.1			1.1b				
3.14.2.2			1.1b				
3.14.2.3	2b						
3.14.3	7		1.1b				
3.14.3.1	7		1.1b				
3.14.3.2	7		1.1b				
3.15							X
3.15.1	2abc, 1.1ab	1.1a	1.1ab				
3.15.1.1	2b,1.1b	1.1b	1.1b				
3.15.2	2b,1.2b	2b,1.2b					
3.15.3	4a	4a	4a				
3.15.4	2c		1.2c				3
3.15.5	2c		1.1c				
3.15.6	2c						
3.16							X
3.16.1	7		4c				
3.16.2	7		4c				
3.16.3	2c		4c				
3.16.3.1	2c		4c,1.1c				
3.16.3.2	2c		4c,1.1c				
3.16.4	2c		4c				
3.16.5	2c		4c,1.1c				

**VERIFICATION REQUIREMENTS MATRIX**

SECTION 3.0  PARA. NO.	VERIFICATION BY LEVEL AND METHOD						NOTES
	D	Q	PHASE A P F			N/A	
3.16.6	2c		4c				
3.16.7						X	
3.16.7.1							TBD
3.16.7.2	2c						
3.16.7.3	2c						
3.16.7.4							TBD
3.17						X	
3.17.1	2c						
3.17.2	2c						
3.17.3	7,2a		1.1b				
3.17.4	7		1.1c				
3.17.4.1	7,2c		1.1c				
3.17.4.2	7						
3.18	7,2b						
3.18.1	2bc						
3.18.2	7		1.1b				
3.18.3	2bc	1.2abc					
3.18.4	2bc						
3.18.5	7						
3.18.6	2bc	1.2c					
3.19						X	
3.19.1						X	
3.19.2	2b						
3.19.3	2b		1.1b				
3.19.4			1.1b				
3.19.5	7		4b,1.1c				
3.19.6			1.1bc				
3.19.7	7		1.1b				
3.19.8						X	
3.19.9	7		4b				
3.19.10	7		1.1b				
3.19.11			1.1b				TBD
3.20	7		4b,1.1b				
3.20.1			4b				
3.20.2	7						
3.20.2.1			4b				

**VERIFICATION REQUIREMENTS MATRIX**

SECTION 3.0  PARA. NO.	VERIFICATION BY LEVEL AND METHOD						NOTES
	D	Q	PHASE			N/A	
			A	P	F		
3.20.2.2						X	
3.20.2.2.1			1.1b				
3.20.2.2.2						X	
3.20.2.3						X	
3.20.2.3.1			1.1b				
3.20.2.3.1.1						X	
3.20.2.4						X	
3.20.2.4.1			1.1b,1.1 c				
3.20.2.4.2						X	
3.20.2.4.3			1.1b,1.1 c				
3.20.2.4.4	7		1.1b,1.1 c				
3.20.2.4.5	7		1.1b,1.1 c				
3.20.2.5			4b				
3.20.2.6						X	
3.20.3						X	
3.20.3.1						X	
3.20.3.2						X	
3.20.3.3						X	
3.20.3.3.1						X	
3.20.3.3.2						X	
3.20.3.3.3						X	
3.20.3.3.4						X	
3.20.3.3.5			1.1b,1.1 c				
3.20.3.4			1.1b				
3.20.3.4.1			1.1b				
3.20.3.5			1.1b				
3.20.3.6						X	
3.21	7,2abc		1.1abc, 2abc,4c				
3.21.1	7						
3.21.2	7		4c				
3.21.3	7		4c				
3.21.4	7		4a				
3.21.5	2abc		1.1abc				
3.21.6	2c						
3.21.7	2c						

VERIFICATION REQUIREMENTS MATRIX

SECTION 3.0	VERIFICATION BY LEVEL AND METHOD						NOTES
	D	Q	PHASE			N/A	
PARA. NO.			A	P	F		
3.21.8						X	
3.22						X	
3.22.1	7						
3.22.2	7						
3.22.2.1	7						
3.22.2.1.1	7		1.1c				
3.22.2.1.2	7		1.1c				
3.22.2.1.3	7		1.1c				
3.22.2.1.4	7						
3.22.2.2	7						
3.22.2.2.1						X	
3.22.2.2.1.1	7		1.1c				
3.22.2.2.1.2	7		1.1c				
3.22.2.2.1.3	7		1.1c				
3.22.2.2.1.4	7		1.1c				
3.22.2.3	7						
3.22.2.4	7		4b,1.1c				
3.22.2.5	7		1.1c				
3.22.3	7						
3.22.3.1	7						
3.22.3.2	7		1a,4a				
3.22.3.3	7		4c				
3.23						X	
3.23.1			4c				
3.23.2			4c				
3.23.2.1	2c						
3.23.3			4c				
3.23.4			4b				
3.24						X	
3.24.1	7		3c,1.1c				
3.24.2	7		3c,1.1c				
3.25						X	
3.26						X	
3.26.1	2c	1.2c,1.1c	1.1c				
3.26.2	2c	1.2c,1.1c	1.1c				4
3.26.2.1	2c	1.2c,1.1c	1.1c				
3.26.2.2	2c		2c				

**VERIFICATION REQUIREMENTS MATRIX**

SECTION 3.0  PARA. NO.	VERIFICATION BY LEVEL AND METHOD						NOTES
	D	Q	PHASE			N/A	
			A	P	F		
3.26.2.3	2c	1.2c,1.1c	1.1c				
3.26.2.4	2c		2c				
3.26.3	2c	1.2c,1.1c	1.1c				
3.26.3.1	2c,7						
3.26.3.2	2c						
3.26.3.3	2c	1.2c,1.1c	1.1c				
3.26.4	2c	1.2c,1.1c	1.1c				
3.26.4.1	2c		4c				
3.26.4.2	2c		4c				
3.27	7		4c				
3.27.1							X
3.27.1.1	2c						
3.27.1.2	7						
3.28							X
3.28.1							X
3.28.2							X
3.28.3							X
3.28.4							X
3.28.4.1							X
3.28.4.1.1			4a				
3.28.4.1.2			4a				
3.28.4.1.3			4a				
3.28.4.1.4			4a				
3.28.4.2	2c						
3.28.4.3			4a,1.1a				
3.28.4.4			4a				
3.28.4.5			4a				
3.28.4.6			4a				
3.28.4.7			4a,1.1a				
3.28.4.8	7		1.1c				
3.28.4.9	7		4abc				
3.28.4.10	7		4abc				
3.28.4.11			4a				
3.28.4.12							X
3.28.4.12.1			1.2c,1.1c				
3.28.4.12.2			1.2c,1.1c				
3.28.4.12.3			1.2c,1.1c				
3.28.4.13	2c		4c				

**VERIFICATION REQUIREMENTS MATRIX**

SECTION 3.0  PARA. NO.	VERIFICATION BY LEVEL AND METHOD						NOTES
	D	Q	PHASE			N/A	
			A	P	F		
3.28.4.14			4a				
3.28.4.15	2c		4c				
3.28.5			4a				
3.28.6			4a				
3.28.7							X
3.28.7.1	2abc		4abc				
3.28.7.2	2abc		4abc				
3.28.7.3	2c		1.1c				
3.28.7.4	2abc	1.2abc	4abc				
3.28.7.5	2abc		4abc				
3.28.7.6			4abc				
3.28.7.7			4abc				
3.28.7.8	2abc		4abc				
3.28.8			4abc				
3.28.9			4abc				
3.28.10			4abc				
3.28.11							X
3.29							X
3.30							X
3.31	7		1c,4c				
3.31.1	7		1.1c				
3.31.1.1	7		1.1c,4c				
3.31.1.2	7		1.1c				
3.31.1.3	7		1.1c				
3.31.1.4	7		4a				
3.31.2	7		4c				
3.31.3	7		1.1c				
3.31.4	7		1.1c,4c				
3.31.5	7		1.1c				

**NOTES:**

- 1 - See S-415-001 paragraph 3.2.1.3 for verification details.
- 2 - See S-415-001 paragraph 3.2.1.5 for verification requirements.
- 3 - Sinesweep
- 4 - Thermal Vacuum

### **2.1.3**

## **VERIFICATION REQUIREMENTS MATRIX**

### **EXAMPLE 2**



**THIS PAGE INTENTIONALLY LEFT BLANK**

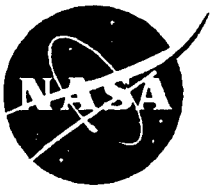

National Aeronautics and  
Space Administration

MSFC-HDBK-2221  
February 1994

---

George C Marshall Space Flight Center  
Marshall Space Flight Center, Alabama 35812

**NATIONAL LAUNCH SYSTEM  
SYSTEMS REQUIREMENTS DOCUMENT, LEVEL III  
VERIFICATION REQUIREMENTS MATRIX**

**EXAMPLE**

**EXAMPLE**

THIS PAGE INTENTIONALLY LEFT BLANK

### VERIFICATION REQUIREMENTS MATRIX CODING KEY

Verification Method/Level		Verification Phases	
Code	Method	Code	Phase
0	Title of Information Only	A	Development
1.0	Similarity	B	Qualification
1.1	Component Similarity	C	Acceptance
1.2	Subsystem Similarity	D	Prelaunch
2.0	Analysis	E	Flight/Mission
2.1	Component Analysis	F	Post Flight
2.2	Subsystem Analysis		
2.3	Integrated Element Analysis		
2.4	Integrated Vehicle Analysis		
3.0	Inspection		
3.1	Component Inspection		
3.2	Subsystem Inspection		
3.3	Integrated Element Inspection		
3.4	Integrated Vehicle Inspection		
3.5	Review of Design Documentation		
4.0	Validation of Records		
4.1	Component Validation of Records		
4.2	Subsystem Validation of Records		
4.3	Integrated Element Validation of Records		
4.4	Integrated Vehicle Validation of Records		
5.0	Demonstration		
5.1	Component Demonstration		
5.2	Subsystem Demonstration		
5.3	Integrated Element Demonstration		
5.4	Integrated Vehicle Demonstration		
6.0	Simulation		
6.1	Component Simulation		
6.2	Subsystem Simulation		
6.3	Integrated Element Simulation		
6.4	Integrated Vehicle Simulation		
7.0	Test		
7.1	Component Functional Test		
7.2	Component Environmental Test		
7.3	Component EMI/EMC Test		
7.4	Component Proof Test		
7.5	Other Component Test		
7.6	Subsystem Functional Test		
7.7	Subsystem Environmental Test		
7.8	Subsystem Proof Test		
7.9	Other Subsystem Test		
7.10	Integrated Element Functional Test		
7.11	Integrated Element Environmental Test		
7.12	Integrated Element EMI/EMC Test		
7.13	Integrated Element Interface Test		
7.14	Other Integrated Element Test		
7.15	Integrated Vehicle Functional Test		
7.16	Integrated Vehicle Environmental Test		
7.17	Integrated Vehicle Interface Test		
7.18	Hot Firing Test		

NLS LEVEL III SRD  
 VERIFICATION REQUIREMENTS MATRIX

MSFC-HDBK-2221  
 February 1994

Paragraph Number	Requirement Statement	Verification By Phase and Method					
		A	B	C	D	E	F
3.0	3.0 REQUIREMENTS	0					
3.0	The LVs shall have a cost per flight lower than those of existing launch vehicles.	0					
3.0	Specifically, the per flight cost after 25 flights for the LVs shall be as specified below: ELEMENT/SUBSYSTEM 1.5 STAGE LV (\$M) HLLV (\$M)STME 27.5 TBD Avionics 6.2 TBD Propulsion System 14.1 TBD Core Stage Tankage 10.4 TBD ASRBs N/A TBD Payload Carrier N/A TBD CTV N/A TBD	0					
3.1	3.1 MISSION REQUIREMENTS	0					
3.1.1	3.1.1 Mission Capabilities	0					
3.1.1	To accomplish its presently baselined mission the LVs shall provide the mission capabilities identified below.	0					
3.1.1.1	3.1.1.1 Mission Flexibility	0					
3.1.1.1	The LV designs shall be capable of accommodating diverse payloads that are designed in accordance with the MSFC-DOC-TBD (PAD).	3.5					
3.1.1.2	3.1.1.2 Launch Vehicle Performance Per Launch	0					
3.1.1.2.1	3.1.1.2.1 1.5 Stage Launch Vehicle	0					
3.1.1.2.1	The 1.5 Stage Launch Vehicle shall have a rated lift capability of at least 50,000 lbs. of payload to an 80 n. mi. x 150 n. mi. orbit inclined 28.5 degrees from CCAFS,	2.4					
3.1.1.2.1	and at least 32,000 lbs. to an 80 n. mi. x 150 n. mi. orbit inclined 90 degrees from VAFB (assuming no right ascension of ascending node (RAAN) requirements).	2.4					
3.1.1.2.1	Through the use of an Upper Stage, the capability to maneuver at least 15,000 lbs. of payload to geosynchronous orbits from KSC/CAFS shall be provided.	2.3					

NLS LEVEL III SRD  
 VERIFICATION REQUIREMENTS MATRIX

MSFC-HDBK-2221  
 February 1994

Paragraph Number	Requirement Statement	Verification By Phase and Method					
		A	B	C	D	E	F
3.1.1.2.2	3.1.1.2.2 HLLV	0					
3.1.1.2.2	The HLLV shall, for the purpose of supporting the SSF, be capable of delivering a CTV, FPM, Payload Carrier, and at least 50,000 lbs. payload to a 15 n. mi. x 220 n. mi. orbit inclined 28.5 degrees.	2.4					
3.1.1.2.2	Through the use of the CTV and FPM, the capability shall be provided to maneuver the payload/Payload Carrier to a 220 n. mi. circular orbit inclined 28.5 degrees and rendezvous with the SSF.	2.3					
3.1.1.2.2	Through the use of the CTV, the capability shall be provided to deliver a payload of TBD Klbs to a 220 n. mi. circular orbit inclined 28.5 deg.	2.3					
3.1.1.2.3	3.1.1.2.3 Vehicle Operating Margin	0					
3.1.1.2.3	The LVs shall be capable of mission success assuming both of the following conditions: A. 3-sigma variations Root Sum Square (RSS) in performance/operating/environmental parameters, or 2-sigma given the occurrence of a major subsystem design failure; and,	2.4					
3.1.1.2.3	B. A single STME, not occurring at any point following launch commit.	2.4					
3.1.1.2.3	For payloads that have RA/TN requirements, the performance capabilities of the LVs would be degraded from the above requirements by launching before or after the nominal launch time.	0					
3.1.1.2.4	3.1.1.2.4 Right Ascension of Ascending Node Capability	0					

NLS LEVEL III SRD  
 VERIFICATION REQUIREMENTS MATRIX

MSFC-HDBK-2221  
 February 1994

Paragraph Number	Requirement Statement	Verification By Phase and Method					
		A	B	C	D	E	F
3.1.1.2.4	The 1.5 Stage LV and HLLV shall have variable launch azimuth capability to satisfy daily launch window requirements which reduce performance penalties associated with ascending node angle requirements for rendezvous missions and tracking aim vectors for lunar/planetary missions. Rendezvous missions to SSF shall have a minimum daily launch window duration of 0.5 hours to meet the payload performance penalty allocation of TBD pounds and provide safe disposal of the Core Stage.	2.4					
3.1.1.2.4	Polar orbit missions shall have a minimum daily launch window duration of TBD hours to meet the payload performance penalty allocation of TBD pounds and provide safe disposal of the Core Stage.	2.4					
3.1.1.2.4	Lunar and planetary missions shall have a minimum daily launch window of 1.0 hour during the launch period and provide safe disposal.	2.4					
3.1.1.2.4	All earth orbital payload placement missions which have no launch azimuth restrictions other than safe core disposal shall provide a launch hold capability of TBD hours to satisfy special payload orbital requirements (e.g. solar heating, earth eclipses).	2.4					
3.1.1.2.4	These launch window requirements shall be satisfied while maintaining LV performance capabilities.	2.4					
3.1.1.3	3.1.1.3 Ascent Trajectory Requirements	0					
3.1.1.3	Ascent Trajectory Design - The flight trajectories shall be designed to not exceed allowable loading (structural, ascent heating, plume heating, high-g loads, venting, etc.) constraints as specified in NLS-DOC-TBD (IEDB), and the MSFC-DOC-TBD (NE), for the nominal mission and in the presence of dispersions such as wind gusts, STME out, off-nominal performance, etc. These loading constraints shall be applied to the vehicle elements (i.e., Core Stage, ASRBs, CTV, FPM, Payload Carrier/Titan IV-derived Payload Carrier and 1.5 Stage LV and HLLV structure) as defined in Section 1.3.2 of this document.	2.4					

NLS LEVEL III SRD  
 VERIFICATION REQUIREMENTS MATRIX

MSFC-HDBK-2221  
 February 1994

Verification By Phase and Method

Paragraph Requirement Statement A B C D E F

Paragraph Number	Requirement Statement	A	B	C	D	E	F
3.1.1.3	The trajectory design must fulfill the reference Mission Requirements in Section 3.1.1.2 of this document.	2.4					
3.1.1.3	It must also satisfy these mission requirements with an STME out capability at launch commit.	2.4					
3.1.1.3	The trajectory design for the HLLV shall allow for retrieval and reuse of the ASRBs.	2.4					
3.1.1.4	3.1.1.4 Delivery Orbit Accuracy	0					
3.1.1.4	The accuracies for payload delivery by the 1.5 Stage LV and HLLV systems are defined in the following sections.	0					
3.1.1.4.1	The 1.5 Stage LV and HLLV/CTV shall achieve the following 3-sigma orbital insertion accuracies independent of the targeted delivery orbit. These requirements shall be met in both the nominal and engine-out cases. MECO ACCURACIES DELIVERY ORBIT PARAMETER HLLV/CTV 1.5 STAGE LV Orbital Inclination (deg.) +/-0.015 TBD Right Ascension of Ascending Node (deg.) +/-0.05 TBD Argument of Perigee (deg.) +/-1.50 TBD True Anomaly (deg.) +/-1.50 TBD Radius of Apogee (n. mi.) +/-5.00 TBD Radius of Perigee (n. mi.) +/-3.00 TBD	2.4					
3.1.1.4.2	The CTV shall achieve the following 3-sigma orbital transfer accuracies independent of the targeted orbit, which does not include the stable orbit rendezvous orbital conditions or proximity berthing conditions. DIRECTION POSITION (feet) VELOCITY (ft/s) Radial +/- 1500 +/- 5.0 Transverse +/- 20,000 +/- 10.0 Normal +/- 1500 +/- 5.0	2.3					
3.1.1.4.2.1	The CTV shall achieve the following 3-sigma stable orbit rendezvous transfer accuracies: DIRECTION POSITION (feet) VELOCITY (ft/s) Radial +/- 660 +/- 5.0 Transverse +/- 660 +/- 5.0 Normal +/- 660 +/- 5.0	2.3					
3.1.1.4.2.2	The CTV shall achieve the following 3-sigma proximity handover accuracies relative to the SSF: DIRECTION POSITION (feet) VELOCITY (ft/s) Radial +/- 30 +/- 0.3 Transverse +/- 30 +/- 0.3 Normal +/- 30 +/- 0.3	2.3					



NLS LEVEL III SRD  
 VERIFICATION REQUIREMENTS MATRIX

MSFC-HDBK-2221  
 February 1994

Paragraph Number	Requirement Statement	Verification By Phase and Method					
		A	B	C	D	E	F
3.2	3.2 PROVISIONS FOR MAN-RATING	0					
3.2	Basic vehicle design shall include design safety factors, reliability, and health monitoring necessary for manned flight.	2.4, 3.5					
3.2	The design of all flight-critical systems shall utilize high reliability parts and components, as defined in Section 3.20.5.14.	2.1, 3.5	4.1	4.1			
3.2	All critical systems whose failure could result in loss of vehicle shall utilize, as a minimum, fail-safe design.	2.2, 3.5					
3.2	The design shall provide an emergency detection system (EDS) as defined in Section 3.4.10.3.	3.5					
3.3	3.3 OPERATIONS REQUIREMENTS	0					
3.3.1	3.3.1 Ground Operations Launch Vehicle Requirements	0					
3.3.1.1	3.3.1.1 Operational Readiness Requirements	0					
3.3.1.1.1	The 1.5 Stage LV and HLLV shall provide an operational time fraction (see Section 3.1.1) of at least TBD for total 1.5 stage LV and HLLV flight rates up to 14 flights per year.	2.4					
3.3.1.1.2	At each launch site, Launch Vehicles shall meet a 90 percent probability of being able to conduct launches within ten days of their scheduled dates (as defined no later than when vehicle integration begins).	2.4					
3.3.1.1.2	The LVs shall also meet a 95 percent probability of being able to conduct launches within twenty days of their scheduled dates.	2.4					
3.3.1.1.2	The LVs shall have the capability for launch in daylight or darkness.	2.4					
3.3.1.1.3	The LVs shall incorporate means of discharging electrical potential differences between the Payload Carrier, payload, LV elements (e.g., Payload Carrier Adapter), and ground in accordance with Section 3.20.5.7.	2.4, 3.5			7.14, 7.17		

NLS LEVEL III SRD  
 VERIFICATION REQUIREMENTS MATRIX

MSFC-HDBK-2221  
 February 1994

Paragraph Number	Requirement Statement	Verification By Phase and Method					
		A	B	C	D	E	F
3.3.1.1.4	3.3.1.1.4 Sustainable Launch Rates	0					
3.3.1.1.4.1	The LVs shall be designed to support a maximum scheduled launch rate of three flights per year from KSC.	3.5					
3.3.1.1.4.2	The 1.5 Stage LV shall be designed to support a maximum scheduled launch rate of 14 flights per year (includes 4 flights to meet resiliency requirements) from CCAFS.	3.5					
3.3.1.1.5	3.3.1.1.5 Special Operational Requirements	0					
3.3.1.1.5.1	The 1.5 Stage LV shall be capable of accommodating requirements to launch a specified payload no more than 30 calendar days after notification. The launch call-up payload must conform to 1.5 Stage LV payload requirements and be destined for one of the 1.5 Stage LV standard delivery orbits. Launch call-up payloads have priority over normally scheduled payloads. This requirement does not apply to the HLLV.	2.4					
3.3.1.1.5.2	For both low-inclination (from CCAFS) and high-inclination (from VAFB) missions, the 1.5 Stage LV shall be capable of supporting surge-ready status (i.e., capable of launching three flights within five calendar days), following 35 days' notification. The system shall be capable of holding a surge-ready status indefinitely, assuming that normal operations have ceased. Following such a surge, the LV shall be capable of reattaining a surge-ready status within 60 calendar days while also accomplishing normal launch operations for at least the first 30 calendar days of this period. The maximum number of surge notifications in any one year period will not exceed two. At Initial Launch Capability (ILC), the 1.5 Stage LV shall be capable of launching TBD flights within TBD days following 30 days' notification. These surge requirements do not apply to KSC launches nor to the HLLV.	2.4					

NLS LEVEL III SRD  
 VERIFICATION REQUIREMENTS MATRIX

MSFC-HDBK-2221  
 February 1994

Verification By Phase and Method

Paragraph Number	Requirement Statement	A	B	C	D	E	F
3.3.1.1.5.3	The LVs shall be capable of accommodating payload assignment changes within the lift capability of the vehicle being processed up to five calendar days before a scheduled launch. The new payload must conform to 1.5 Stage LV and HLLV payload requirements and standard delivery orbits. Payload replacement shall be accomplished by replacement of the entire encapsulated payload or payload/Upper Stage combination, and shall be completed in five calendar days or less following notification to replace the payload. Following payload replacement, the launch system shall be at the same number of days before launch as when the payload change notification was received.	3.5, 2.4, 2.3					
3.3.1.2	The LV designs shall be compatible with the manufacturing operations defined in NLS-DOC-TBD (MFG).						
3.3.1.3	3.3.1.3 Launch Vehicle Processing Operations	0					
3.3.1.3.1	3.3.1.3.1 Kennedy Space Center						
3.3.1.3.1	The 1.5 Stage LV and the HLLV shall be compatible with processing operations and Kennedy Space Center facilities from receipt of vehicle elements at the launch site through launch and refurbishment.	2.4, 3.4					
3.3.1.4	3.3.1.4 Pre-Launch Checkout of the LVs	0					
3.3.1.4	Pre-Launch checkout shall be accomplished using LV ground support equipment (GSE), the KSC Launch Processing System (LPS), and the CCAFS (TBD).				5.4		
3.3.1.4	The LVs shall provide for automated checkout operations.	3.5					
3.3.1.4	The LV designs should minimize the required number of support personnel.	0					
3.3.1.5	3.3.1.5 Launch Pad Operations	0					
3.3.1.5.1	Automated launch control systems shall have overrides to prevent personal injury or launch vehicle damage in the event of a system malfunction.	3.5 (Facilities CDR)			7.10 (Ground Systems)		

NLS LEVEL III SRD  
 VERIFICATION REQUIREMENTS MATRIX

MSFC-HDBK-2221  
 February 1994

Verification By Phase and Method

Paragraph Number	Requirement Statement	A	B	C	D	E	F
3.3.1.5.2	The LVs shall be capable of maintaining a ready-to-launch status with a full load of propellants for up to 8 hours.	2.4, 3.5	7.6				
3.3.1.5.3	The LVs shall be capable of being recycled for launch, following a pre-engine ignition launch scrub resulting from non-vehicle problems, in no more than 16 hours.	2.4, 3.5					
3.3.1.5.4	The LVs shall have a capability for fail-safe abort (1 failure tolerant) including safe liquid engine shutdown from a full thrust condition, after a cutoff signal has been received prior to the start of an event within the operational sequence where there no longer exists a safe backout procedure to delay lift-off (launch commit).	3.5	2.2				
3.3.1.5.5	The LVs shall require no more than 168 clock hours between payload access in an integration facility and launch. If launch does not occur within the 168 clock hours, the vehicle, if necessary, shall be returned to an integration facility for access to the payload no more than 72 clock hours after the decision to return.	2.4			5.4		
3.3.1.5.6	Positive clearances shall exist between the LVs and all ground launch facility hard points from vehicle lift-off through tower clearance for both nominal and intab abort modes. Vehicle clearance and drift during lift-off shall be within the envelopes specified in ICD-TBD (ICD2).	2.4	2.4				
3.3.2	3.3.2 Mission Operations Launch Vehicle Requirements	0					
3.3.2.1	Acceptable operating envelopes for each standard mission shall be as defined by MSFC-DOC-TBD (PAD).	2.4					
3.3.2.2	The LV ascent performance and payload capabilities shall be based on the mission requirements specified in Section 3.1.	2.4					
3.3.2.2	During the period of ascent operations (time from launch commit through payload separation), the LV shall provide ascent performance and vehicle health information to the ground.			7.10	7.15		

NLS LEVEL III SRD  
 VERIFICATION REQUIREMENTS MATRIX

MSFC-HDBK-2221  
 February 1994

Paragraph Number	Requirement Statement	Verification By Phase and Method					
		A	B	C	D	E	F
3.3.2.3	The CTV shall provide the capability to operate for a minimum of TBD hours, with payload services as defined in MSFC-DOC-TBD (PAD) through payload delivery/deployment and an additional TBD hours through Payload Carrier disposal and return to the Space Station.	2.3	2.3	2.3			
3.3.2.3	For SSF missions, visual references shall be provided for proximity operations. The locations of these references are TBD.	2.3	2.3	2.3			
3.3.2.4	The 1.5 Stage LV and HLLV shall provide for safe disposal (including trajectory and debris dispersions) or recovery of all LV components and all payload equipments which are not deployed with the payload.	2.4					
3.3.2.4	Disposal from low earth orbit shall be in safe ocean areas as defined below: A. No closer than 200 n. mi. from foreign land masses B. No closer than 25 n. mi. from U.S. territories and the Continental United States (CONUS) C. North of 60 degrees South latitude	2.4					
3.4	3.4 GENERAL LV DESIGN/PERFORMANCE REQUIREMENTS	0					
3.4.1	3.4.1 Safety Factors	0					
3.4.1	Safety factors for newly designed 1.5 Stage LV and HLLV structures shall conform to MSFC-HDBK-505, Chapter 3.	2.1, 2.2, 3.5, 4.2, 4.4, 7.4, 7.5	2.1, 2.2, 3.5, 4.2, 4.4, 7.2, 7.4, 7.5, 7.7, 7.8, 7.9				
3.4.1	Any existing structures to be incorporated in the 1.5 Stage LV and HLLV shall be evaluated to ensure compliance with the requirements in MSFC-HDBK-505.	2.1, 2.2, 4.4, 7.2, 7.4, 7.5	2.1, 2.2, 4.4, 7.2, 7.4, 7.5, 7.7, 7.8, 7.9				

NLS LEVEL III SRD  
 VERIFICATION REQUIREMENTS MATRIX

MSFC-HDBK-2221  
 February 1994

Paragraph Number	Requirement Statement	Verification By Phase and Method					
		A	B	C	D	E	F
3.4.2	3.4.2 Fatigue	0					
3.4.2	A structural strength program of analysis and testing shall be followed in accordance with MSFC-HDBK-505. Fatigue service life will be based upon requirements set forth for man rated systems in MSFC-HDBK-505.	2.1, 2.2	2.1, 2.2, 4.2				
3.4.2	Safe life design shall be adopted for all major load-carrying structures. These structures shall be capable of surviving without failure a total number of mission cycles that is a minimum of four times greater than the total number of mission cycles expected in service (shown by analysis or test through a rationally derived cyclic loading and temperature spectrum). This does not preclude fail-safe structural features.	2.1, 2.2	2.1, 2.2, 7.4, 7.5, 7.7, 7.8, 7.9				
3.4.3	3.4.3 Fracture Control and Creep	0					
3.4.3	Fracture control and creep analyses shall be conducted as defined in MSFC-HDBK-1453 and MSFC-HDBK-505. Allowable stresses and other related properties of materials and structural elements will be obtained from MSFC-HDBK-5.	2.1, 2.2, 4.1	2.1, 2.2, 4.4				
3.4.3	Failure critical 1.5 Stage LV and HLLV components shall be controlled in design, fabrication, test and operation by a MSFC-approved fracture control plan as specified in MSFC-HDBK-505.	4.1	4.4				
3.4.3	Designs for primary structure, glass components, and all pressure vessels shall consider the presence of sharp cracks, crack-like flaws, or other stress concentrations in determining the life of the structure for sustained loads and cyclic loads coupled with environmental effects.	2.1, 2.2	2.1, 2.2, 7.2	3.1, 7.4			
3.4.3	Parts determined to be fracture critical, including all pressure vessels, shall be controlled in design, fabrication, test, and operation by a MSFC-approved fracture control plan.	4.1	4.4				
3.4.3	The 1.5 Stage LV and HLLV structures that are newly developed shall conform to fatigue and fracture control and creep requirements as specified in MSFC-HDBK-1453.	2.1, 2.2, 4.1	2.1, 2.2, 4.4, 7.2				

NLS LEVEL III SRD  
 VERIFICATION REQUIREMENTS MATRIX

MSFC-HDBK-2221  
 February 1994

Paragraph Number	Requirement Statement	Verification By Phase and Method					
		A	B	C	D	E	F
3.4.3	The 1.5 Stage LV and HLLV parts determined to be fracture critical shall be subjected to fracture mechanics analysis and inspection of structures and subsystems as specified in MSFC-HDBK-1453.	2.1, 2.2	2.1, 2.2	3.1			
3.4.3	The NDE (Non-destructive Evaluation) techniques required to fulfill the demands of a MSFC Fracture Control Program shall follow the standards set forth in MSFC-STD-1249.	3.5					
3.4.3	Fracture control requirements for all 1.5 Stage LV and HLLV flight structures shall be as specified in MSFC-HDBK-1453.	3.5					
3.4.4	3.4.4 Design Loads	0					
3.4.4	A. The 1.5 Stage LV and HLLV shall meet all induced static, dynamic, acoustic, and thermal loading as defined in NLS-DOC-TBD (IEDB).	2.4	2.4, 7.2, 7.7				
3.4.4	B. The 1.5 Stage LV and HLLV shall accommodate static and dynamic structural deformations and responses, including aeroelasticity effects under all limit load conditions and NLS operating environments. The 1.5 Stage LV and HLLV, upon accommodating structural deformations and responses, shall not cause a system malfunction, preclude the stability of a vehicle, or allow unintentional hardware contact.	2.4	2.4, 7.2, 7.7				
3.4.4	C. The limit load for the Payload Carrier Adapter shall accommodate the payload, CTV, FPM, and Payload Carrier mass.	2.1	2.1, 7.2				
3.4.4	D. The 1.5 Stage LV and HLLV structures shall be capable of withstanding all load effects under limit load conditions without exceeding 1.5 Stage LV and HLLV envelopes as defined in ICD-TBD (1.5MP) and ICD-TBD (HLLVMP), respectively.	2.4	2.4, 7.2, 7.7				
3.4.4	E. The 1.5 Stage LV and HLLV structures shall have adequate strength and stiffness, at the design temperature, to withstand limit loads and pressures without loss of operational capability or failure for the life of the vehicles.	2.4	2.4, 7.2, 7.7				

NLS LEVEL III SRD  
VERIFICATION REQUIREMENTS MATRIX

MSFC-HDBK-2221  
February 1994

Verification By Phase and Method

Paragraph Number	Requirement Statement	A	B	C	D	E	F
3.4.4	F. Safe life design shall be incorporated for all major load-carrying structures.	3.5					
3.4.4	G. The 1.5 Stage LV and HLLV design loads and interface loads shall be determined by coupled dynamic loads analysis. Dynamic models and forcing functions shall be used to establish transient dynamic loads.	2.4	2.4, 7.2				
3.4.4.1	3.4.4.1 Max-Q	0					
3.4.4.1	The 1.5 Stage LV flight trajectories shall be designed to not exceed a maximum aerodynamic pressure on the 1.5 Stage LV of TBD lbs/ft <sup>2</sup> . The HLLV flight trajectories shall be designed to not exceed a maximum aerodynamic pressure on the HLLV structure of TBD lbs/ft <sup>2</sup> .	2.4, 3.5					
3.4.4.2	3.4.4.2 Maximum G-Load	0					
3.4.4.2	The 1.5 Stage LV shall be designed to not produce an x-axis g-load exceeding 4.5 g's at any time during the ascent portion of the flight trajectory. The HLLV shall be designed to not produce an x-axis g-load exceeding 4.0 g's at any time during the ascent portion of the flight trajectory.	2.4, 3.5					
3.4.4.5	3.4.4.5 Venting	0					
3.4.4.5.1	Component designs shall provide for ground venting to ensure that design-allowable pressure differentials are not exceeded during transportation and test.	2.1,3.5					
3.4.4.5.2	3.4.4.5.2 Ascent/On-orbit/Descent	0					
3.4.4.5.2	All compartments, cavities, and components which are not structurally capable of withstanding the ascent/descent pressure profiles as defined in NLS-DOC-TBD (IEDB) shall be vented to maintain acceptable pressure differentials.	3.5					
3.4.4.5.2	The Payload Carrier internal atmosphere shall be isolated from the Interstage atmosphere.	3.5					



NLS LEVEL III SRD  
 VERIFICATION REQUIREMENTS MATRIX

MSFC-HDBK-2221  
 February 1994

Paragraph Number	Requirement Statement	Verification By Phase and Method					
		A	B	C	D	E	F
3.4.4.5.2	Each compartment (e.g., Payload Carrier, Interstage, Forward Skirt) shall vent independently.	2.3,3.5					
3.4.4.5.2	The vent design of the Payload Carrier shall allow for the venting of payloads into the compartment volume.	2.3,3.5					
3.4.5	3.4.5 Static and Dynamic Aeroelasticity	0					
3.4.5	Static and dynamic structural deformations and responses, including the effects of aeroelasticity under all limit conditions and environments, shall be accounted for in the structural design and shall not cause a system malfunction, not preclude the stable control of the vehicle, and not cause unintentional contact between adjacent hardware.	2.4	2.4				
3.4.5	The LVs shall be free from flutter and buzz at dynamic pressures up to 1.32 times the maximum dynamic pressure expected during flight.	2.4	2.4				
3.4.5	Lifting surfaces (if used) shall be free from "divergence" and aerodynamic control surfaces (if used) shall not exhibit reversal at dynamic pressures up to 1.32 times the maximum dynamic pressures at the appropriate Mach number, or boost, abort, entry, and dynamic flight envelopes.	2.4	2.4				
3.4.6	Pyrotechnic systems shall be designed to meet the requirements of MSFC-DOC-TBD (PYRO).	3.5, 4.1					
3.4.6.1	Pyrotechnic systems shall be capable of self-contained checkout to ensure that all necessary connections and capabilities are intact. The capability shall be provided to perform pyrotechnic systems checkout at any time during the launch cycle, up to lift-off.	2.3	5.3, 7.7?	7.6			
3.4.6.2	Pyrotechnic systems shall be capable of installation into the 1.5 Stage LV and HLLV remote from the launch site, preferably at the 1.5 Stage LV and HLLV manufacturing/assembly facilities.	2.3	5.3				

NLS LEVEL III SRD  
 VERIFICATION REQUIREMENTS MATRIX

MSFC-HDBK-2221  
 February 1994

Paragraph Number	Requirement Statement	Verification By Phase and Method					
		A	B	C	D	E	F
3.4.6.3	Pyrotechnic systems shall be insensitive to electromagnetic interference (EMI), electromagnetic pulse (EMP), radio frequency (RF), electrostatic discharge (ESD), radar, and lightning and other environments as described in NLS-DOC-TBD (IEDB).	2.3	7.7				
3.4.6.4	Pyrotechnic systems shall not use any secondary explosives more sensitive than pentaerythrite petranitrate (PETN). Primary explosives shall only be used with the approval of the responsible NASA engineering office.		2.3, 4.3				
3.4.7	The LVs shall be designed to preclude the shedding of debris, including ice, during pre-launch and flight operations that would jeopardize the vehicle, mission success, or would adversely impact turnaround operations.	2.4					
3.4.8	Design and operational criteria of controlled environment areas shall be in conformance with MSFC-STD-246-class 100,000 environment as amended in the MSFC-DOC-TBD (LVCCD).	3.5	4.4				
3.4.8	Surface cleanliness requirements as specified by MSFC-SPEC-164, MIL-STD-1246, JSC SN-C-0005, and KSC-SPEC-23 for environment cleanliness level of 100,000 shall be followed.	3.5	4.4				
3.4.8	Requirements for outgassing from components and subsystems shall be followed as set forth in MSFC-SPEC-311.	3.5, 4.4					
3.4.9	The design target weights for the 1.5 Stage LV and the HLLV flight hardware shall not exceed the weights specified in Tables 1 and 2.			4.4	4.4		
3.4.9	Core Stage Interstage Assembly 11,400 Forward Skirt Assembly 2,700 LOX Tank Assembly 20,250 Intertank Assembly 7,800 LH2 Tank Assembly 37,650 Aft Skirt Assembly 7,000 Propulsion Module 51,850 Interface and Support Hardware 1,800 Engines (6 STMEs) 54,600 (9100 per engine) Propellants Usable 1,641,000 Residual 20,987 Shroud and Separation System 12,500 Payload 50,000 minimum Upper Stage TBD			4.4	4.4		
3.4.9	The 1.5 Stage LV payload c.g. envelope and the HLLV payload c.g. envelope are given in MSFC-DOC-TBD (PAD).			4.4	4.4		

NLS LEVEL III SRD  
 VERIFICATION REQUIREMENTS MATRIX

MSFC-HDBK-2221  
 February 1994

Verification By Phase and Method

Paragraph Number	Requirement Statement	A	B	C	D	E	F
3.4.10	The Vehicle Health Management (VHM) function shall correlate the vehicle health status from all subfunctions, remain cognizant of the status of similar signals from the terminators, and relay information to other subfunctions that may be affected.	3.5		7.10	7.15		
3.4.10	The 1.5 Stage LV and HLLV shall incorporate a condition monitoring system capable of providing analysis of real-time, pre- and post-flight maintenance information.	3.5		7.10	7.15		
3.4.10	The avionics shall receive performance, engineering and health monitor information from all vehicle subsystems, synthesize this information, and assess vehicle health to advise on appropriate actions.	3.5		7.10	7.15		
3.4.10	Vehicle health management shall determine failure condition and shall notify other functions or subfunctions that a hazard has been detected.	3.5		7.10	7.15		
3.4.10.1	The 1.5 Stage LV and HLLV design shall incorporate distributed fault tolerance and vehicle health management hardware/software systems for launch vehicle automated checkout and operation.	3.5		7.10	7.15		
3.4.10.1	The HLLV design shall incorporate distributed fault tolerance and vehicle health management hardware/software systems for: A. Launch vehicle automated checkout and operation, and B. CTV/FPM/Payload Carrier/payload checkout and operation.	3.5		7.10	7.15		
3.4.10.1	The 1.5 Stage LV and HLLV vehicle health management system shall be capable of detecting and isolating abnormal performance and impending failures, to the Line Replaceable Unit (LRU) level and identifying corrective actions, including reconfiguration or shutdown.	3.5		7.10	7.15		
3.4.10.2	Fault-tolerant avionics hardware and software shall be incorporated into the 1.5 Stage LV and HLLV design to provide real-time fault management and reliability equivalent to that of redundant reusable systems, but compatible with the low-cost expendable system objectives of the 1.5 Stage LV and HLLV.	3.5		7.10	7.15		

NLS LEVEL III SRD  
 VERIFICATION REQUIREMENTS MATRIX

MSFC-HDBK-2221  
 February 1994

Verification By Phase and Method

Paragraph Number	Requirement Statement	A	B	C	D	E	F
3.4.10.3	Launch vehicle design shall provide a redundant active Emergency Detection System (EDS) for all manned flights.	3.5					
3.4.10.3	The EDS shall monitor all LV failure modes which could result in loss of vehicle both pre-launch and throughout powered flight.	3.5		7.10	7.15		
3.4.10.3	The EDS shall provide redundant data outputs to initiate the payload-provided Crew Escape System (CES) in the event of a credible emergency condition. The crew then has the option to activate the Launch Escape System (LES).	3.5		7.10	7.15		
3.4.10.3	The EDS shall utilize operational sensor data to determine vehicle status/failure modes.	3.5		7.10	7.15		
3.4.10.3	The EDS shall accommodate health monitoring and self-test.	3.5					
3.4.11.1	A Vehicle and Data Management (V&DM) function shall be provided to perform executive monitoring and control of the on-board functions and coordinate communications between the on-board functions and ground control. This function shall control the operational mode of all other on-board avionics functions.	3.5		7.10	7.15		
3.4.11.1	The V&DM function shall accommodate health monitoring and self-test.	3.5		7.10	7.15		
3.4.11.1.1	A command processing function shall validate commands that are received from the ground, stored program, or SSF for the current vehicle configuration and operational mode.	2.0 (all), 5.0 (all)	7.10	7.10	7.15		
3.4.11.1.1	The command processing shall relay valid commands to accomplish mode control.		7.10	7.10	7.15		
3.4.11.1.2	Mode control capability shall be provided to set the operational modes of all vehicle subsystems. Mode control shall include system initialization, event sequencing, system state assessment, and system fault management.	3.5, 2.0 (all), 5.0 (all)	7.10	7.10	7.15		
3.4.11.1.3	Test control capability shall be provided to control and conduct subsystem tests when required (authorized).	2.0 (all)	2.0 (all), 7.10	7.10	7.15		

NLS LEVEL III SRD  
 VERIFICATION REQUIREMENTS MATRIX

MSFC-HDBK-2221  
 February 1994

Paragraph Number	Requirement Statement	Verification By Phase and Method					
		A	B	C	D	E	F
3.4.11.1.4	Vehicle timekeeping capability shall be provided to maintain the master clock and synchronization of the on-board systems.	2.0 (all), 5.0 (all)	2.0 (all), 7 .10	7.10	7.15		
3.4.11.1.5	System services shall be provided to support the operation of the rest of the vehicle functions. These services shall include: task scheduling, intertask communications, data bus communications, interrupt handling, and data management system fault tolerance control.	3.5, 2.0 (all), 5.0 (all)	2.0 (all), 7.10	7.10	7.15		
3.4.11.1.5	The instrumentation data handling subsystem shall monitor and select other vehicle subsystems using standard signal (data) sampling and conditioning techniques that will be stored for further analysis and for downlink.	3.5, 2.0 (all), 5.0 (all)	2.0 (all), 7.10	7.10	7.15		
3.4.11.2	A Telemetry and Command function shall be provided for timely, accurate, and secure exchange of command data to the vehicle (via V&DM) from the external interfaces and the transmission of telemetry data to these external interfaces.	3.5, 2.0 (all)	2.0 (all)	7.10	7.15		
3.4.11.2	The avionics shall format, store, receive, transmit and encode telemetry, perform RF link control, and interface with instrumentation.	2.0 (all), 3.5	2.0 (all)	7.10	7.15		
3.4.11.2	Telemetry and Command shall accommodate health monitoring and self test.	2.0 (all), 3.5	2.0 (all)	7.10	7.15		
3.4.11.3	A Propulsion Control function shall be provided to control and monitor the propulsion systems.	2.2		2.4			
3.4.11.3	This function shall include engine start-up, shut down, thrust level setting events; propellant management; gas system management; and thruster valve control.	2.2		2.4, 7.10	7.15		
3.4.11.3	The 1.5 Stage LV and HLLV avionics shall be designed to provide for throttling, staging, and abort capabilities.	2.2, 3.5		7.6			
3.4.11.4	A Mechanisms and Ordnance Control function shall be provided to control vehicle mechanisms, verify vehicle interfaces, and initiate devices necessary for staging or other ordnance- activated events.	3.5, 2.2		2.2 7.10	7.15		

NLS LEVEL III SRD  
VERIFICATION REQUIREMENTS MATRIX

MSFC-HDBK-2221  
February 1994

Paragraph Number	Requirement Statement	Verification By Phase and Method					
		A	B	C	D	E	F
3.4.11.5	A power management and distribution (PMAD) function shall be provided to control and monitor the distribution of electrical power (see Section 3.20.5).	2.2, 3.5, 5.2	7.10	2.2, 7.10	7.15		
3.4.11.5	The PMAD function shall control and monitor energy sources as applicable, the transfer of electrical power between power sources, and the power-up and power-down sequencing.	2.2, 5.2	7.10	7.10	7.15		
3.4.11.5	The PMAD function shall meet the following requirements:	0					
3.4.11.5	A. The PMAD function shall have the capability to receive power from Ground Support Equipment (GSE). The switching of power sources shall be accomplished such that no loss of power or significant power surge is experienced by the LV subsystems.	2.2, 3.5	2.2, 7.10	7.10	7.15		
3.4.11.5	B. The PMAD function shall provide redundant power to safety critical circuits. Automatic and remotely controlled fault isolation capabilities shall be provided on selected components. The Electrical Power System (EPS) design shall support LV fault tolerance requirements of Section TBD.	2.2, 3.5					
3.4.11.5	C. The PMAD function shall accept commands from the LV computer to control electrical loads during all mission phases.	2.2	7.10	7.10	7.15		
3.4.11.7	The Development Flight Instrumentation (DFI) system shall consist of strain, temperature, pressure, force and vibration sensors and the associated cabling, signal conditioning, multiplexing, recording, transmitting, and mechanical attachment of hardware necessary to acquire the flight performance data of the complete vehicle during ascent and required flight periods as defined in TBD.	3.5					
3.4.11.7	There shall be a DFI system on four flights of both the 1.5 Stage LV and HLLV configurations (total of eight flights).	3.5					
3.4.11.7	The remaining two flights shall be selected from the next TBD flights that are expected to have more severe ascent environments.	3.5					

NLS LEVEL III SRD  
 VERIFICATION REQUIREMENTS MATRIX

MSFC-HDBK-2221  
 February 1994

Paragraph Number	Requirement Statement	Verification By Phase and Method					
		A	B	C	D	E	F
3.4.11.8	The Avionics boxes shall be capable of mating to a surface having a 2.00 inch grid pattern using 0.25 inch fasteners.	3.5					
3.4.12	The LV elements shall conform with the moldline envelopes specified in ICD-TBD (1.5MP) and ICD-TBD (HLLVMP).	2.4					
3.5	3.5 Core Stage Design/Performance Requirements	0					
3.5.1	3.5.1 Structure	0					
3.5.1.1	3.5.1.1 General	0					
3.5.1.1.1	3.5.1.1.1 Interstage	0					
3.5.1.1.1	The Interstage shall provide structural transition from the Payload Carrier Adapter to the Core Stage and shall transfer payload/Payload Carrier loads to the Core Stage.	2.2, 3.5	7.2				
3.5.1.1.1	The Interstage shall interface with the Payload Carrier Adapter at the forward end and the Forward Skirt at the aft end.	3.5					
3.5.1.1.2	3.5.1.1.2 Tankage	0					
3.5.1.1.2.1	The Forward Skirt shall provide the structural transition from the Interstage to the Core Stage tankage.	2.2, 3.5	7.2				
3.5.1.1.2.1	It shall raise the Interstage far enough above the forward tank to prevent interference between the Interstage and the forward tank dome.	2.3, 3.5	7.2				
3.5.1.1.2.2	3.5.1.1.2.2 LOX Tank	0					
3.5.1.1.2.2	It shall also provide structural transition between its forward and aft interfacing structural elements.	2.2, 3.5	7.2				
3.5.1.1.2.4	3.5.1.1.2.4 LH2 Tank	0					
3.5.1.1.2.4	It shall also provide structural transition between its interfacing forward and aft structural elements.	2.2, 3.5	7.2				
3.5.1.1.2.5	3.5.1.1.2.5 Aft Skirt	0					

NLS LEVEL III SRD  
 VERIFICATION REQUIREMENTS MATRIX

MSFC-HDBK-2221  
 February 1994

Verification By Phase and Method

Paragraph Number	Requirement Statement	A	B	C	D	E	F
3.5.1.1.2.5	The Aft Skirt shall provide the structural transition from the Core Stage tankage to the Thrust Structure.	2.2, 3.5	7.2				
3.5.1.1.2.6	3.5.1.1.2.6 Tankage Size	0					
3.5.1.1.2.6	The tankage shall be sized to accommodate the Core Stage propellant loading required to accomplish the missions as defined in Sections 3.1.1. and 3.1.2.	2.4, 3.5					
3.5.1.1.2.9	3.5.1.1.2.9 Handling	0					
3.5.1.1.2.9	The tankage with thermal protection system installed shall be capable of being hoisted, erected, transported, and handled without requiring insulation inspection or special verification subsequent to completion of the handling activity.		5.2				
3.5.1.1.2.1	3.5.1.1.2.10 Structural Stability	0					
3.5.1.1.2.1	The tankage structure, with attached payload carrier/payload, shall not require pressurization or GSE support for stability during ground handling, transportation, or in either fueled or unfueled condition while on the launch pad for winds as defined in MSFC DOC WBD (NE). However, ullage pressure management may be required by the tankage during propellant fill and drain operations for structural stability.	2.4			5.4		
3.5.1.1.2.1	3.5.1.1.2.11 Propellant SLOSH Damping	0					
3.5.1.1.2.1	The LOX Tank slosh damping shall be 5 percent.	3.5, 2.3?	7.6, 7.10				
3.5.1.1.2.1	The tankage shall be provided with a ground-commanded system to disperse the tankage propellants. The components shall be designed to be readily added or removed, where possible.	3.5	7.6				
3.5.1.1.2.1	The system shall be protected against auto-detonation until after rupture has occurred as defined in Section 3.15.2.10.	3.5	7.6				
3.5.1.2.1	The Booster Thrust Structure shall provide structural attachment for the Booster STMEs and structural load distribution from these STMEs to the Aft Skirt.	3.5, 2.2	7.2				



NLS LEVEL III SRD  
 VERIFICATION REQUIREMENTS MATRIX

MSFC-HDBK-2221  
 February 1994

Verification By Phase and Method

Paragraph Number	Requirement Statement	A	B	C	D	E	F
3.5.1.2.1	It shall also provide for a holddown and release capability on the Mobile Launch Platform (MLP).	3.5					
3.5.1.2.1	The Booster Thrust Structure shall allow for propellant line mounting and thrust vector control actuator support structure.	3.5					
3.5.1.2.2	The Sustainer Thrust Structure shall provide structural attachment for the Sustainer STMEs and structural load distribution from these STMEs to the Aft Skirt.	3.5, 2.2	7.2				
3.5.1.3	3.5.1.3 Heavy Lift Launch Vehicle	0					
3.5.1.3.1	The Intertank shall provide structural continuity between the LOX and LH2 Tanks and shall receive and distribute all thrust loads from the ASRBs.	3.5, 2.2					
3.5.1.3.2	3.5.1.3.2 Thrust Structure	0					
3.5.1.3.2	The Thrust Structure shall provide structural attachment for the STMEs and structural load distribution from the STMEs to the Aft Skirt.	3.5, 2.2	7.2				
3.5.2	3.5.2 Propulsion	0					
3.5.2.1	3.5.2.1 General	0					
3.5.2.1.1	The main propulsion system (MPS) shall provide usable propellant at the engine mixture of 6.0 oxidizer-to-fuel ratio (O/F) in order to accomplish the reference missions. The usable propellant requirement includes planned propellant consumption plus flight performance reserve.	2.2		7.6			
3.5.2.1.1.1	The MPS shall provide propellant with a loading accuracy of TBD percent for LOX and TBD percent for LH2.	2.2	7.6	7.6			
3.5.2.1.2	3.5.2.1.2 LOX Feed System	0					
3.5.2.1.2.1	The LOX feed system shall be capable of loading LOX subsequent to loading LH2. The LOX Tank feed system shall be capable of unloading LOX prior to LH2 Tank unloading.	2.2, 3.5	7.6		7.10		

NLS LEVEL III SRD  
VERIFICATION REQUIREMENTS MATRIX

MSFC-HDBK-2221  
February 1994

Paragraph Number	Requirement Statement	Verification By Phase and Method					
		A	B	C	D	E	F
3.5.2.1.2.2	The LOX feed system shall be designed to preclude damaging geysers. The geyser suppression system design shall not require ground interfaces.	3.5, 2.2					
3.5.2.1.2.3	The LOX system shall provide propellant depletion signals for STME cutoff.	3.5	7.6				
3.5.2.1.4	3.5.2.1.4 LOX Pressurization	0					
3.5.2.1.4	The MPS shall be designed to pre-pressurize the Core Stage LOX Tank prior to engine start by using ground-supplied helium.	2.3, 3.5	7.6		7.10		
3.5.2.1.4	The Core Stage LOX pressurization system shall maintain LOX Tank ullage pressure as specified in ICD-TBD.	2.3, 3.5	7.6		7.10		
3.5.2.1.4	The LOX pre-pressurization and ascent pressurization shall be performed to pressure levels to satisfy the LOX Tank structural requirements as specified in MSFC-SFBE-TBD (CSCEI) and engine LOX inlet pressure requirements as specified in ICD-TBD (STME/NLS).	2.3, 3.5	7.6		7.10		
3.5.2.1.6	The pneumatic system shall be capable of interfacing with the ground system to allow compartment purges with gaseous Nitrogen on the launch pad.	3.5, 2.4			5.4		
3.5.2.1.7	During ascent, there shall be no propellant tank venting under nominal conditions.	2.4				5.4	
3.5.2.1.7.2	3.5.2.1.7.2 H2 Venting	0					
3.5.2.1.7.2	The H2 vent system shall be connected to a facility line for safe disposal.				5.4		
3.5.2.1.7.2	Facility back pressure at the Facility/Core Stage interface shall not exceed the values specified in ICD-TBD (1.5/MLP) and ICD-TBD (HLLV/MLP).	2.4			5.4, 7.17		
3.5.2.1.7.2	The vent valves shall be capable of being opened and closed by ground command prior to				5.4, 7.15		
3.5.2.1.9	3.5.2.1.9 Thrust Vector Control (TVC) System	0					

NLS LEVEL III SRD  
 VERIFICATION REQUIREMENTS MATRIX

MSFC-HDBK-2221  
 February 1994

Paragraph Number	Requirement Statement	Verification By Phase and Method					
		A	B	C	D	E	F
3.5.2.1.9	A. The TVC actuation system shall provide the capability for independent motion of each engine about the pitch and yaw axes.	2.2					
3.5.2.1.9	B. The TVC actuation system shall provide an engine gimbal angle of +/- TBD deg. square pattern with TBD maximum diagonal gimbal angle in either or both pitch and yaw axes simultaneously.	2.2	7.6, 7.18				
3.5.2.1.9	C. No single failure within the TVC system shall affect the operability of the system.	2.2					
3.5.2.21.	3.5.2.2 1.5 Stage LV	0					
3.5.2.2.1	The 1.5 Stage LV MPS shall be capable of providing the impulse required of the Core Stage by the mission trajectory.	3.5, 2.2					
3.5.2.2.2	The LV designs shall ensure that when the engines are staged, propellants are not released which would create a hazard to any element of the LV, payload, and crew.	3.5, 2.4					
3.5.2.2.3	A. Engine-out roll control from staging through MECO.	3.5, 2.4					
3.5.2.2.3	B. Three axis attitude control during the coast and de-orbit thruster burn.	3.5, 2.4					
3.5.2.2.3	C. De-orbit of the Core from an 80 n. mi. x 150 n. mi. orbit to a safe disposal zone as defined in Section 3.3.2.4.	2.2					
3.5.3.1	3.5.3.1 Vehicle & Data Management	0					
3.5.3.1.2	The Core Stage avionics shall initiate and control the CS/ASRB separation sequence.	3.5					

NLS LEVEL III SRD  
VERIFICATION REQUIREMENTS MATRIX

MSFC-HDBK-2221  
February 1994

Paragraph Number	Requirement Statement	Verification By Phase and Method					
		A	B	C	D	E	F
3.5.3.1.2	In preparation for and during ASRB separation, the Core Stage avionics shall: A. Provide for separation sequencing for each ASRB, including arming and firing the separation pyrotechnics and safing the ASRB range safety system. B. Provide for ASRB automatic TVC (ATVC) power deadfacing and fixed positioning of the ASRB exhaust nozzles. C. Issue ASRB separation command at a time from separation sequence initiation which assures that the thrust of each ASRB does not exceed the values in Table TBD.	3.5					
3.5.3.2	3.5.3.2 Telemetry & Command	0					
3.5.3.2	The LV Core Stage telemetry & command function shall interface with the ground system.	3.5					
3.5.3.2	It shall be capable of accepting data loads and commands generated in the ground system and transmitted via ground cable.	3.5					
3.5.3.2	The LV avionics telemetry shall support Ground Spaceflight Tracking and Data Network (GSTDN) operation.	3.5					
3.5.3.2	The LV ascent telemetry data shall be transmitted in real time to a GSTDN ground station with no on-board capability provided for recording or subsequent playback.	3.5					
3.5.3.2	The LV ascent telemetry data rate shall not exceed 1024 kbps including encoding/encryption.	3.5					
3.5.3.3	3.5.3.3 Guidance, Navigation, and Control (GN&C)	0					
3.5.3.3.1	A GN&C subsystem shall be provided for each launch vehicle configuration to achieve desired targeted conditions, as specified in Section 3.1.1.4.1, while adhering to system constraints in the presence of allowable variations in the vehicle and its environment as defined in NLS-DOC-TBD (GN&C).	3.5					
3.5.3.3.1	The GN&C subsystem shall be operational prior to initiation and execution of the lift-off sequence and shall function until payload separation.	3.5			5.4	5.4	

NLS LEVEL III SRD  
VERIFICATION REQUIREMENTS MATRIX

MSFC-HDBK-2221  
February 1994

Paragraph Number	Requirement Statement	Verification By Phase and Method					
		A	B	C	D	E	F
3.5.3.3.1	The GN&C shall provide the command to jettison the payload fairing.	3.5					
3.5.3.3.1	A guidance function shall be provided to generate flight steering commands and targeting parameters.	3.5					
3.5.3.3.1	Guidance shall generate alerts regarding the ability of the vehicle to achieve the targeted orbit.	3.5					
3.5.3.3.1	Faults in redundant sensor processing and aiding sensor processing due to specific sensor hardware or software failures shall not adversely affect the stand alone performance of the inertial navigation system (INS).	3.5					
3.5.3.3.1	A flight control function shall be provided to command control effectors to execute steering commands generated by the guidance function and to maintain vehicle stability.	3.5, 2.2					
3.5.3.4	3.5.3.4 Propulsion Control						
3.5.3.4	The Propulsion Control avionics shall be able to command STME throttling over the range of nominal thrust minus TBD percent and plus TBD percent.	2.2	7.6				
3.5.4	The 1.5 Stage LV and HL LV shall be free of instabilities resulting from dynamic coupling of the structure, propulsion, and flight control subsystems during all phases of powered flight with all payload variations.	2.4					
3.5.7	3.5.7 Separation	0					
3.5.7.1	All separation systems shall provide for separation without damage or re-contact of separated components.	3.5, 2.2	7.6, 3.1				
3.5.7.1	The separation systems shall not release any debris or contaminants which would cause damage to any system or subsystem of the Core Stage or payload.	3.5	7.6, 3.1				
3.5.7.21.	3.5.7.2 1.5 Stage LV	0					

NLS LEVEL III SRD  
 VERIFICATION REQUIREMENTS MATRIX

MSFC-HDBK-2221  
 February 1994

Paragraph Number	Requirement Statement	Verification By Phase and Method					
		A	B	C	D	E	F
3.5.7.2.1	The BPM separation system shall provide for separation for both the nominal and the one sustainer STME-failed cases.	3.5					
3.5.7.2.1	The launch vehicle body rates shall be no greater than TBD deg/sec roll, TBD deg/sec pitch, and TBD deg/sec yaw at the time of separation.	2.4					
3.5.7.2.1	The crew and ground control shall have the capability to manually override the automatic inhibit command.	3.5					
3.5.7.2.2	3.5.7.2.2 Trisector Fairing Separation	0					
3.5.7.2.2	The launch vehicle body rates shall be no greater than TBD deg/sec roll, TBD deg/sec pitch, and TBD deg/sec yaw at the time of separation.	2.4				7.15	
3.5.7.3.3	3.5.7.3.3 Fairing Separation	0					
3.5.7.3.3	The initiation and control of the Fairing separation shall be the responsibility of the Core Stage.	2.5					
3.5.7.3.3	The Core Stage body rates shall be no greater than TBD deg/sec roll, TBD deg/sec pitch, and TBD deg/sec yaw at the time of separation.	2.4				7.15	
3.5.7.3.3	The separation velocity of the Fairing relative to the Core Stage shall be at least TBD ft/sec.	2.4					
3.5.7.3.4	3.5.7.3.4 Payload Carrier Separation From the Core Stage	0					
3.5.7.3.4	The Payload Carrier shall be deployed in the forward direction within TBD degrees fly-away angle with respect to the Core Stage body axis (Figure 4).	2.4					
3.5.7.3.4	The Core Stage body rates shall be no greater than TBD deg/sec roll, TBD deg/sec pitch, and TBD deg/sec yaw at the time of separation.	2.4				7.15	
3.5.7.3.4	The separation velocity of the Payload Carrier relative to the Core Stage shall be TBD ft/sec.	2.4					
3.11	3.11 STME DESIGN/PERFORMANCE REQUIREMENTS	0					

NLS LEVEL III SRD  
 VERIFICATION REQUIREMENTS MATRIX

MSFC-HDBK-2221  
 February 1994

Paragraph Number	Requirement Statement	Verification By Phase and Method					
		A	B	C	D	E	F
3.11	The STMEs shall provide the required propulsion to achieve the 1.5 Stage Launch Vehicle performance and, in conjunction with the ASRBs, the HLLV performance.	2.3, 3.5					
3.11.1	The following single-engine performance shall be provided by the STME: PARAMETER VACUUM* SEA LEVEL** Thrust (Klbs) 650 +/- 2% TBD Mixture Ratio 6:1 +/- 1.5% TBD Isp (lb-sec/lbm) 431.0 +/- 2.5% TBD * Vacuum defined as 3.6 x 10 <sup>-5</sup> deg. R, 0.6243 x 10 <sup>-21</sup> lb/ft <sup>3</sup> density, and 10-10 Torr pressure. ** Sea Level defined as 518.4 deg. R, 0.07647 lb/ft <sup>3</sup> density, and 14.696 psi of pressure.	2.3	7.18				
3.11.2	A. A LOX bleed shall be provided by the STME at 0.5 lbm/sec at prestart pressure	3.5	7.18				
3.11.2	B. Step throttlable to 70 percent	3.5	7.18				
3.12	3.12 LAUNCH VEHICLE INTERFACES	0					
3.12.1.2	The Core Stage shall interface with the Ground Spaceflight Tracking and Data Network, and detailed requirements shall be as defined in ICD-TBD (CS/GSTDN).	2.4			7.17		
3.12.2.31	3.12.2.3 1.5 Stage Launch Vehicle/Mobile Launch Platform	0					
3.12.2.31	The 1.5 Stage V shall interface with the Mobile Launch Platform, and detailed requirements shall be as defined in ICD-TBD (1.5/MLP).	2.4			5.4		
3.12.3	3.12.3 HLLV Interface Requirements	0					
3.12.3.1	The ASRBs shall interface with the Core Stage, and detailed requirements shall be as defined in ICD-TBD (CS/ASRB).	2.3, 3.5			7.17		
3.12.3.4	3.12.3.4 CTV/Payload Carrier	0					
3.12.3.10	3.12.3.10 HLLV/Mobile Launch Platform	0					
3.12.3.10	The HLLV shall interface with the Mobile Launch Platform, and detailed requirements shall be as defined in ICD-TBD (HLLV/MLP).	2.4			5.4		
3.13	3.13 ENVIRONMENTS	0					

NLS LEVEL III SRD  
 VERIFICATION REQUIREMENTS MATRIX

MSFC-HDBK-2221  
 February 1994

Paragraph Number	Requirement Statement	Verification By Phase and Method					
		A	B	C	D	E	F
3.13.1	The Launch Vehicles shall be designed to meet the requirements of MSFC-DOC-TBD (NE). This capability or protection shall be provided while on or in transit to/from the launch pad and in flight.	2.4, 3.5					
3.14	The 1.5 Stage LV and HLLV elements shall be environmentally acceptable, by meeting the requirements of all applicable federal and state laws.	2.4					
3.15	3.15 SAFETY REQUIREMENTS	0					
3.15.1	3.15.1 Ground Safety	0					
3.15.1.1	Launch vehicle safing shall be provided by GSE during ground turnaround, maintenance, and refurbishment operations.	3.15					
3.15.2	3.15.2 Flight Safety	0					
3.15.2.1	The LVs shall have capability to provide early warning of hazardous conditions and provisions for corrective action, abort action, and mission termination.	3.15		7.15			
3.15.2.2	The LV materials shall be selected with characteristics which do not present hazards to personnel or equipment in their intended use or environment.	2.1, 3.5					
3.15.2.3	Provisions shall be made to physically isolate or separate hazardous incompatible subsystems, materials, and environments.	3.5					
3.15.2.6	Flight vehicle subsystems shall be designed to prevent accidental activation/deactivation of safety-critical functions or equipment which would be hazardous to personnel or vehicles during flight or ground operations.	3.5					
3.15.2.7	Flight vehicle batteries shall be isolated and surrounding equipment protected against battery explosion.	3.5					
3.15.2.9	Pressure vessels shall be protected against overpressurization or underpressurization which could be hazardous to personnel or flight vehicle.	3.5	7.6				



NLS LEVEL III SRD  
 VERIFICATION REQUIREMENTS MATRIX

MSFC-HDBK-2221  
 February 1994

Paragraph Number	Requirement Statement	Verification By Phase and Method					
		A	B	C	D	E	F
3.15.2.10	The 1.5 Stage LV and HLLV shall comply with the applicable launch site range safety requirements (i.e., ESMCR 127-1 for the Eastern Launch Site and WSMCR 127-1 for the Western Launch Site).	3.5					
3.15.2.11	The flight vehicles shall be designed to preclude the concentration of flammable gases in critical areas and closed compartments from exceeding the lower flammable limit for the combination of gases that may be present both pre-launch and during flight.	3.5					
3.15.2.11	The flight vehicles shall provide a sampling of the concentrations of Hydrogen and Oxygen where these fluids could exist.	3.5					
3.15.2.12	A hazardous gas detection system capable of periodic sampling of concentrations of Hydrogen and Oxygen in the Core Stage critical areas and closed compartments during ascent shall be provided.	3.5					
3.16	3.16 RELIABILITY REQUIREMENTS	0					
3.16	The 1.5 Stage LV and HLLV shall have mission reliabilities as defined in Section 3.1.2.	2.4					
3.16.1.1	The design reliability of the 1.5 Stage LV shall be 0.99	2.4					
3.16.2	3.16.2 Redundancy	0					
3.16.2	The redundancy requirements for critical flight vehicle subsystems (except structure, thermal protective system, individual subsystem basis but shall not be less than fail-safe during all mission phases. The fail-safe requirement does not apply to the premature firing mode of pyrotechnic devices and functional systems except associated avionics and circuitry.	2.2, 3.5					
3.16.2	Flight hardware will be designed to sustain a failure of a single item of hardware and software in any subsystem without loss of life or vehicle.	3.5, 2.4					

NLS LEVEL III SRD  
 VERIFICATION REQUIREMENTS MATRIX

MSFC-HDBK-2221  
 February 1994

Paragraph Number	Requirement Statement	Verification By Phase and Method					
		A	B	C	D	E	F
3.16.2.1	Redundant systems, redundant subsystems, and redundant major elements of subsystems (such as assemblies, panels, power supplies, tanks, controls, and associated interconnecting wiring and fluid lines) shall be separated, or otherwise protected, to ensure that an unexpected event that damages one is not likely to prevent the other from performing that function.	3.5					
3.16.2.2	Electrical wiring of redundant systems, redundant subsystems, or redundant major elements of subsystems shall not be routed in the same bundle or through the same connector with wiring of the other system, subsystem, or subsystem element.	3.5					
3.16.2.3	Redundant functional paths or subsystems shall be designed so that their operational status can be verified during ground operations without removal of LRUs.	3.5					
3.16.2.3	Exceptions to the in-flight verification requirement of redundant functional paths include: A. Standby Redundancy (redundant paths where only one path is operational at any given time). B. All functional paths of any subsystem which is inoperative during such inoperative periods). C. Pyrotechnic devices. D. Mechanical linkages.	3.5					
3.16.2.3	Redundancies within a functional path shall be so designed that their operational status can be verified prior to each installation into the vehicle.	3.5					
3.17	<b>3.17 QUALITY ASSURANCE REQUIREMENTS</b>	0					
3.17	The LV designs and manufacturing shall comply with quality assurance provisions in MSFC-HDBK-TBD (QA).	3.5					
3.18	<b>3.18 MAINTAINABILITY REQUIREMENTS</b>	0					
3.18.1	The 1.5 Stage LV and HLLV should be designed to minimize required maintenance and post-failure stand-down time.	2.4					

NLS LEVEL III SRD  
 VERIFICATION REQUIREMENTS MATRIX

MSFC-HDBK-2221  
 February 1994

Verification By Phase and Method

Paragraph Number	Requirement Statement	A	B	C	D	E	F
3.18.1	Hardware designs should consider human factors, interchangeability and accessibility of components and parts, use of on-board fault detection and isolation systems, maintenance personnel and skill requirements, and facility and GSE requirements.	0					
3.18.2	<b>MAINTENANCE MEASUREMENT REQUIREMENT</b> Fault Detection and Isolation to LRU level Time TBD hours Maximum LRU Access Time TBD hours Maximum LRU Replacement Time (including disassembly, removal, repair and replace, re-assembly, align and calibrate, and checkout) TBD hours Average LRU Replacement Time (including disassembly, removal, repair and replace, re-assembly, align and calibrate, and checkout) TBD hours Vehicle Close Out TBD hours	2.4					
3.18.3	3.18.3 Accessibility	0					
3.18.3	Flight systems, subsystems, equipments and components should be designed with features that contribute to the ease and rapidity of maintenance.	0					
3.18.3.1	3.18.3.1 Location	0					
3.18.3.1	The vehicle subsystems should be designed so that equipment is located in areas that minimize the requirements for GSE and facility support equipment (e.g. platforms, swingarms).	0					
3.18.3.2	3.18.3.2 Arrangement	0					
3.18.3.2	The vehicle subsystem components should be arranged to permit close proximity of units relating to a particular subsystem for convenience in testing and troubleshooting.	0					
3.18.4.1	The flight vehicle interfaces shall allow interchangeability between any production vehicle element or encapsulated payload that may be selected to be mated or installed.	3.5			5.4		
3.18.4.2	The flight vehicle hardware shall be interchangeable except for those selected items which will be replaceable.	3.5					

NLS LEVEL III SRD  
 VERIFICATION REQUIREMENTS MATRIX

MSFC-HDBK-2221  
 February 1994

Paragraph Number	Requirement Statement	Verification By Phase and Method					
		A	B	C	D	E	F
3.19.5	The LVs shall meet the requirements of NHB 6000.1.	3.5					
3.20.1	The selection of specifications shall be in accordance with MM8070.2, except for approved tailored specifications.	0					
3.20.2	Engineering drawings, electrical diagrams, schematics and associated lists for in-house drawings shall be in accordance with MSFC-STD-555.	0					
3.20.2	Contractor drawings shall be in accordance with MIL-STD-100.	0					
3.20.5	Electrical power shall be supplied independently by each LV element with the exception of the ASRB.	3.5					
3.20.5	Electrical power returns from all loads shall not use the structure for power return.	3.5					
3.20.5.1	Crimp and wire wrap electrical connections shall be in accordance with NHB 5300.4(3H).			4.1			
3.20.5.2	Soldered electrical connections shall be in accordance with NHB 5300.4(3A-F).			4.1			
3.20.5.3	Printed wiring boards shall be in accordance with NHB 5300.4(3I) and NHB 5300.4(3K).	4.1					
3.20.5.4	Requirements for conformal coating and staking of printed wiring boards and electronic assemblies shall be in accordance with NHB 5300.4(3J).	4.1					
3.20.5.5	Requirements for interconnecting cables, harnesses, and wiring shall be in accordance with NHB 5300.4(3G).			4.1			
3.20.5.6	3.20.5.6 Grounding	0					
3.20.5.6.1	The DC power grounding shall be in accordance with MSFC-SPEC-TBD (EME).	3.5					
3.20.5.6.1	The DC power circuit returns shall be isolated from structure except at a Single Point Ground (SPG).	3.5					

NLS LEVEL III SRD  
 VERIFICATION REQUIREMENTS MATRIX

MSFC-HDBK-2221  
 February 1994

Verification By Phase and Method

Paragraph Number	Requirement Statement	A	B	C	D	E	F
3.20.5.6.1	Power returns to and within each box/unit shall have a one megohm minimum resistance to the box/unit case or structure.			7.5			
3.20.5.6.1	Secondary power returns shall be isolated from primary power returns by one megohm dc resistance.	3.5		7.9, 7.14	7.17		
3.20.5.6.1	Secondary power shall use individual SPGs.	3.5		7.9, 7.14	7.17		
3.20.5.6.1	The SPGs shall not be utilized as a normal current-carrying path.	3.5					
3.20.5.6.2	Signal returns and control circuits referenced to LV power shall be isolated from box/unit case or structure.	3.5		7.3	7.17		
3.20.5.7	Electrical bonding shall be in accordance with MIL-B-5087 and MSFC-SPEC-TBD (EME).	3.5		7.5, 7.9, 7.13	7.17		
3.20.5.8	3.20.5.8 Shielding						
3.20.5.8.1	Individual circuit shielding shall be in accordance with MSFC-SPEC-TBD (EME).	3.5					
3.20.5.8.1	Circuit shielding shall be used to protect low level/sensitive circuits and to reduce radiation from potential high nose level circuits.	3.5					
3.20.5.8.1	Individual circuit shields shall cover twisted pairs, triplets, etc.	3.5					
3.20.5.8.1	All the return current shall be contained within the same shield as the outgoing current.	3.5					
3.20.5.8.2	3.20.5.8.2 Overall Shields	0					
3.20.5.8.2	Overall Shields shall be in accordance with MSFC-SPEC-TBD (EME) as modified by the element EME Control Plan.	3.5					
3.20.5.8.2	The overall shield shall be isolated from individual shields by TBD megohms dc resistance and connected to structure ground at each harness connector.			7.5			

NLS LEVEL III SRD  
 VERIFICATION REQUIREMENTS MATRIX

MSFC-HDBK-2221  
 February 1994

Paragraph Number	Requirement Statement	Verification By Phase and Method					
		A	B	C	D	E	F
3.20.5.9	Electrical fault protection shall be in accordance with TBD.	2.4, 3.5					
3.20.5.10	The LV shall be designed to be compatible within itself and with other interfacing systems in accordance with MSFC-SPEC-TBD (EME).	2.4, 3.5					
3.20.5.10	The electrical and electronic components shall meet the requirements of MSFC-SPEC-TBD (EME) and MIL-STD-462, as modified by the EME Control Plan.	3.5	7.3	7.3			
3.20.5.11	The LV flight systems, subsystems, elements, equipment, components, and materials shall be selected and designed to prevent electrostatic buildup and discharge.	3.5, 4.0(all )					
3.20.5.11	Electronic equipment and components shall be designed to withstand ESDs equal to or less than 4000 volts to the case or to any pin on exposed external connectors.	3.5, 2.4					
3.20.5.12	High voltage design shall be in accordance with the criteria specified in MSFC-STD-531.	2.4, 3.5					
3.20.5.12	Corona suppression shall be in accordance with MSFC-SPEC-TBD (EME) as modified by the element EME Control Plan.	2.4					
3.20.5.13	The LV system and elements shall be designed in accordance with MSFC-SPEC-TBD (EME) and MSFC-SPEC-TBD (LPR), as modified by the EME Control Plan for each element. The specifications shall be used for verification that the flight vehicle, facilities, and shipping and handling equipment design meet requirements and specifically identify the analysis and test methods to be used.	2.4					
3.20.5.13	Lightning protection for payloads shall be in accordance with MSFC-SPEC-TBD (EME) as modified by the element EME Control Plan.	2.4					
3.20.5.14	Electrical, electronic, and electromechanical parts shall be in accordance with NHB 5300.4(1F) and MIL-STD-975. Grade 1 EEE parts are not mandatory.			4.1			
3.20.6	3.20.6 Mechanical Fasteners	0					

NLS LEVEL III SRD  
VERIFICATION REQUIREMENTS MATRIX

MSFC-HDBK-2221  
February 1994

Verification By Phase and Method

Paragraph Number	Requirement Statement	A	B	C	D	E	F
3.20.6	Fastener allowable strength shall be in accordance with MIL-HDBK-5.			4.1			
3.20.6	Installation torque values for threaded fasteners shall be per MSFC-STD-486.			3.1			
3.20.6	Threaded fasteners used on safety-critical flight hardware shall be in accordance with MSFC-STD-561.			4.1			
3.20.8.1	All materials of construction shall meet the applicable requirements of MSFC-STD-506.						
3.20.8.1	All metallic materials used shall meet the requirements of MSFC-SPEC-522.			4.1			
3.20.8.1	A material usage agreement shall be submitted for each material required for use in all cases where the material does not meet the applicable requirements of MSFC-STD-506.			4.1			
3.20.8.2	All materials which are exposed to space vacuum and/or used near critical surfaces shall meet the outgassing requirements of JSC-SP-10022.			4.1			
3.20.8.3	All metallic materials used in structures, attachment hardware, and support bracketry shall meet the stress corrosion requirements of MSFC-SPEC-522.			4.1			
3.20.8.4	Dissimilar metals shall not be used in combination unless they are suitably coated to prevent electrolytic corrosion (see MSFC-SPEC-250).			4.1			
3.20.8.5	Finishes shall be in accordance with MSFC-SPEC-250. Cadmium plating shall not be used as a finish material.			4.1			
3.20.8.6	Materials used shall meet the flammability requirements of NHB 8060.1.			4.1			
3.20.8.7	Brazing shall be in accordance with Specification MIL-B-7883.			4.1			
3.20.9	Automatic identification and marking shall be in accordance with TBD.			3.1			

NLS LEVEL III SRD  
 VERIFICATION REQUIREMENTS MATRIX

MSFC-HDBK-2221  
 February 1994

Paragraph Number	Requirement Statement	Verification By Phase and Method					
		A	B	C	D	E	F
3.20.10	The hardware and software should be free of defects which could result in hazardous or unsafe conditions or which could result in failure of the system or materially reduce the usability of the system for its intended purpose.	0					
3.20.11	Equipment, structures, and components shall be designed to preclude hazard to personnel and damage to equipment through handling and inadvertent contact by ground personnel.	3.5					
3.20.12	The LV coordinate systems shall be as defined in Appendix B of this document.	3.5					

**EXAMPLE**



## **2.2**

# **VERIFICATION PLAN**

## 2.2.1 INTRODUCTION

The Verification Plan documents and describes the overall verification program that is planned for a project. The Verification Plan example provided in this section describes both a protoflight verification program and a verification program that utilizes qualification hardware. However, a project does not normally have a protoflight verification program and also utilize qualification hardware at the integrated payload level.

The example for the Verification Plan has been developed using sections of the following documents: (1) the Hubble Space Telescope, Assembly and Verification Plan, AV-05, SAV-1000 - prepared by the Lockheed Missiles and Space Company, Space Systems Division, for the Hubble Space Telescope Program; (2) the Orbital Maneuvering Vehicle (OMV) Verification Plan, D08942 - prepared by TRW, Electronics and Defense Sector for the OMV Program; (3) the Advanced X-Ray Astrophysics Facility (AXAF) Verification Plan, VR01 - prepared by TRW for the AXAF Program; (4) the Hubble Space Telescope Phase III Safety Report, Volumes I and II, for JSC, ST/SE-28 - prepared by the Lockheed Missiles and Space Company, Space Systems Division, for the Hubble Space Telescope Program; and (5) the Hubble Space Telescope Phase III Safety Report for KSC, ST/SE-28 - prepared by the Lockheed Missiles and Space Company, Space Systems Division, for the Hubble Space Telescope Program. The example provides visibility of the type and depth of information required in a Verification Plan.

## **2.2.2**

# **VERIFICATION PLAN**

## **EXAMPLE**

**THIS PAGE INTENTIONALLY LEFT BLANK**

**TABLE OF CONTENTS**

1.0	INTRODUCTION.....	2.2-16
1.1	Scope.....	2.2-16
1.2	Applicable Documents.....	2.2-16
1.3	Document Maintenance And Control.....	2.2-18
2.0	DESCRIPTION OF THE HUBBLE SPACE TELESCOPE.....	2.2-19
2.1	Deployment Mission.....	2.2-19
2.2	Systems Description.....	2.2-19
2.2.1	Support Systems Module.....	2.2-21
2.2.2	Optical Telescope Assembly.....	2.2-22
2.2.2.1	Optical Telescope Assembly Equipment Section.....	2.2-23
2.2.3	Fine Guidance System.....	2.2-23
2.2.4	Scientific Instruments.....	2.2-23
2.2.4.1	Faint Object Camera.....	2.2-23
2.2.4.2	High Resolution Spectrograph.....	2.2-24
2.2.4.3	High Speed Photometer.....	2.2-24
2.2.4.4	Faint Object Spectrograph.....	2.2-24
2.2.4.5	Wide Field/Planetary Camera.....	2.2-25
2.2.4.6	Scientific Instrument Control and Data Handling Module.....	2.2-25
2.2.5	Solar Array.....	2.2-25
2.3	Subsystems.....	2.2-25
2.3.1	Electrical Power Subsystem.....	2.2-25
2.3.1.1	Batteries.....	2.2-26
2.3.1.2	Battery Protection and Reconditioning Circuit.....	2.2-26
2.3.1.3	Charge Current Controller.....	2.2-26
2.3.1.4	Power Distribution Unit.....	2.2-26
2.3.1.5	Power Control Unit.....	2.2-26
2.3.2	Instrumentation and Communications Subsystem.....	2.2-27
2.3.2.1	Instrumentation Control Unit.....	2.2-27
2.3.2.2	Multiple Access Transponder.....	2.2-27
2.3.2.3	S-Band Single Access Transmitter.....	2.2-27
2.3.2.4	Antennas and Pointing System.....	2.2-27
2.3.2.5	Circulator Switch.....	2.2-28
2.3.2.6	RF Multiplexer.....	2.2-28
2.3.2.7	RF Switches.....	2.2-28
2.3.2.8	RF Transfer Switches.....	2.2-28
2.3.2.9	Diplexers.....	2.2-28
2.3.2.10	Coaxial Cables and Waveguides.....	2.2-28
2.3.3	Structures.....	2.2-28
2.3.3.1	SSM Equipment Section.....	2.2-29
2.3.3.2	Forward Shell.....	2.2-29
2.3.3.3	Light Shield.....	2.2-29
2.3.3.4	Aft Shroud.....	2.2-30
2.3.4	Mechanisms.....	2.2-30
2.3.4.1	Mechanism Control Unit.....	2.2-30
2.3.4.2	Aperture Door Assembly.....	2.2-30
2.3.4.3	High Gain Antennas.....	2.2-31
2.3.4.4	Latch Mechanisms.....	2.2-31
2.3.4.5	Bi-directional Rotary Drive Actuator.....	2.2-31
2.3.5	Pointing Control Subsystem.....	2.2-31
2.3.5.1	Reaction Wheel Assembly.....	2.2-32

2.3.5.2	Coarse Sun Sensor.....	2.2-32
2.3.5.3	Rate Gyro Assembly.....	2.2-33
2.3.5.4	Fine Guidance Sensor.....	2.2-33
2.3.5.5	Fixed Head Star Tracker.....	2.2-33
2.3.5.6	Fixed Head Star Tracker Light Shade.....	2.2-33
2.3.5.7	Magnetic Torquer Bars.....	2.2-33
2.3.5.8	Pointing Safe Mode Electronic Assembly.....	2.2-34
2.3.5.9	Magnetic Sensing System.....	2.2-34
2.3.5.10	Retrieval Mode Gyro Assembly.....	2.2-34
2.3.6	Data Management Subsystem.....	2.2-34
2.3.6.1	Digital Computer.....	2.2-35
2.3.6.2	Data Management Unit.....	2.2-35
2.3.6.3	Data Interface Unit.....	2.2-35
2.3.6.4	Engineering/Science Tape Recorders.....	2.2-36
2.3.6.5	Oven-Controlled Crystal Oscillators.....	2.2-36
3.0	SYSTEMS QUALIFICATION VERIFICATION.....	2.2-37
3.1	Modal Survey Test.....	2.2-38
3.2	Thermal Vacuum Test.....	2.2-38
3.3	Vibration Qualification Test.....	2.2-40
3.3.1	Random Vibration Qualification Tests.....	2.2-40
3.3.1.1	Pre-Vibration Testing.....	2.2-41
3.3.1.2	Power-On Vibration Test.....	2.2-41
3.3.1.3	Post-Vibration Functional Test.....	2.2-41
3.3.2	Sinusoidal Vibration Test.....	2.2-41
3.3.3	Pressure Qualification Test.....	2.2-41
3.3.3.1	Proof Pressure Testing.....	2.2-42
3.3.4	Acoustic Test.....	2.2-42
3.3.5	Analysis.....	2.2-42
3.3.5.1	Structures and Mechanisms Analyses.....	2.2-42
3.3.5.1.1	Dynamic Loads Stiffness and Deflection Analysis.....	2.2-43
3.3.5.1.2	Stress, Thermal Distortion, Fracture Mechanics and Venting Analyses.....	2.2-43
3.3.5.1.3	Appendage Deployment Analysis.....	2.2-43
3.3.5.1.4	Avoidance Angle Analysis.....	2.2-43
3.3.5.1.5	AXAF-I On-Orbit Control Weight Analysis.....	2.2-44
3.3.5.1.6	Center of Gravity Analysis.....	2.2-44
3.3.5.2	Thermal Control Subsystem Analysis.....	2.2-44
3.3.5.2.1	Thermal Control Design Analysis.....	2.2-44
3.3.5.2.2	Venting Analysis.....	2.2-44
3.3.5.3	Electrical Power Subsystem.....	2.2-45
3.3.5.3.1	EPS Analyses.....	2.2-45
3.3.5.3.2	Solar Array Analyses of Mechanical and Electrical Adequacy.....	2.2-45
3.3.5.3.3	Battery Analyses.....	2.2-45
3.3.5.4	Communication, Command and Data Management Verification Analyses.....	2.2-45
3.3.5.4.1	Communications Link Margins.....	2.2-45
3.3.5.4.2	Computer/Data Bus Usage Analyses.....	2.2-46
3.3.5.4.3	Data Management Analyses.....	2.2-46
3.3.5.4.4	False/Hazardous Command Probabilities.....	2.2-46
3.3.5.4.5	Safety Analyses.....	2.2-46
3.3.5.4.6	Time Correlation Analysis.....	2.2-46
3.3.5.5	EMC/EMI Analysis.....	2.2-46
4.0	SYSTEMS ACCEPTANCE VERIFICATION.....	2.2-47
4.1	Installation and Prepower Tasks.....	2.2-48

4.2	SSM/ES Functional Test	2.2-48
4.3	Solar Array Receiving and Inspection	2.2-49
4.4	Scientific Instrument Control and Data Handling R&I	2.2-50
4.5	Scientific Instruments R&I	2.2-51
4.6	SSM/ES-SI Assembly and Prepower Tasks	2.2-52
4.7	Non-Powered Optical Telescope Assembly and OTA-Equipment Section R&I	2.2-53
4.8	SSM/ES-SI Systems Integration	2.2-55
4.9	Weight and Center of Gravity	2.2-55
4.10	ST Assembly	2.2-56
4.11	ST Pre-Power Tasks	2.2-57
4.12	ST Hardware/Software System Functional Verification	2.2-57
4.13	Fine Guidance Sensor #3 Installation and Functional Checkout	2.2-59
4.14	ST Hardware/Software System Functional Verification No. 2	2.2-59
4.15	ST Systems End-to-End Test	2.2-59
4.16	ST Modal Survey	2.2-60
4.17	ST EMC Verification	2.2-61
4.18	Mechanisms Installation and Checkout	2.2-62
4.19	FGS Engineering Model Change Out	2.2-63
4.20	ST Acoustic Verification	2.2-63
4.21	ST Post Acoustic Functional and Thermal Vacuum Preparations	2.2-66
4.22	ST Thermal Vacuum/Thermal Balance Verification	2.2-68
4.23	Compatibility Test	2.2-71
4.24	ST Preliminary Shipping Preparations	2.2-72
4.25	ST Pre-Ship Functional Verification, Launch and Orbital Verification Dress Rehearsal	2.2-72
4.26	ST Final Shipping Preparations	2.2-74
4.27	Analysis	2.2-75
4.27.1	Structural Analysis	2.2-75
4.27.1.1	Dynamic Analysis	2.2-75
4.27.1.2	Stress Analysis	2.2-75
4.27.1.3	Mass Properties Analysis	2.2-76
4.27.1.4	Thermal Analysis	2.2-76
4.27.1.5	Fracture Analysis	2.2-76
4.27.2	Optical Analysis	2.2-76
4.27.2.1	X-Ray Optical Analysis	2.2-76
4.27.2.1	Standard Optical Analysis	2.2-77
4.27.3	Environmental Analysis	2.2-77
4.27.3.1	Thermal Environment	2.2-77
4.27.3.2	Radiation Environment	2.2-77
4.27.3.3	Contamination Environment	2.2-77
4.27.3.4	Transportation and Handling	2.2-78
4.27.4	Electrical Analysis	2.2-78
4.28	Inspection	2.2-78
4.29	Verification of Records	2.2-79
4.30	Demonstrations	2.2-79
4.31	Launch Site Verification	2.2-79
4.31.1	Abbreviated Functional Test	2.2-79
4.31.2	Fuel Propulsion System	2.2-79
4.31.3	AXAF-I/Upper Stage Interface Tests	2.2-80
4.31.4	AXAF-I/OCC/DSN Compatibility Checks	2.2-80
4.31.5	Orbiter Mechanical/Electrical Interface Verification Using CITE	2.2-80
4.31.6	Orbiter Interface Verification	2.2-80
4.31.7	End-to-End Data Test	2.2-80
4.31.8	Countdown	2.2-80

4.31.9	Launch .....	2.2-80
4.32	On-Orbit Verification .....	2.2-80
5.0	<b>ST ASSEMBLY AND VERIFICATION ORGANIZATION AND STAFFING</b> .....	2.2-82
5.1	ST Program Management .....	2.2-82
5.2	ST Program Office Management .....	2.2-83
5.2.1	Resident Manager's Office .....	2.2-83
5.2.2	Systems Engineering Office .....	2.2-83
5.3	MSFC Science And Engineering .....	2.2-83
5.3.1	Space Telescope, Chief Engineer's Office .....	2.2-83
5.3.2	Science And Engineering Laboratories .....	2.2-83
5.4	LMSC ST Assembly And Verification Organization .....	2.2-84
5.4.1	ST Verification Team (STVT) .....	2.2-84
5.4.2	SSM/ST Integration Contractor Support .....	2.2-84
5.5	European Space Agency .....	2.2-85
5.5.1	Solar Array .....	2.2-85
5.5.2	Faint Object Camera .....	2.2-86
5.6	Associate Contractors .....	2.2-86
5.6.1	Perkin-Elmer (OTA) .....	2.2-86
5.6.2	Scientific Instruments .....	2.2-86
5.7	SSM/ST Contractor Organization (LSMC) .....	2.2-86
5.7.1	Test Engineering And Data Analysis Organization .....	2.2-87
5.7.1.1	Verification Team .....	2.2-87
5.7.1.2	Test Design and Data Analysis Team .....	2.2-87
5.7.2	Test Operations And GSE/STE Engineering Organization .....	2.2-87
5.7.2.1	Test Operations .....	2.2-88
5.7.2.2	Support Engineering And Control Center .....	2.2-89
5.7.3	ST Support Organizations .....	2.2-89
5.7.3.1	Systems Engineering .....	2.2-90
5.7.3.2	Design Engineering .....	2.2-91
5.7.3.3	Product Assurance .....	2.2-91
5.7.3.4	Mission Operations Contractor .....	2.2-92
5.7.3.5	Flight Software Validation .....	2.2-92
6.0	<b>ST OPERATIONAL RELATIONSHIPS</b> .....	2.2-94
6.1	STVT Scheduling And Review Meetings .....	2.2-94
6.1.1	Timeline Development .....	2.2-95
6.1.2	Daily Work Scheduling .....	2.2-95
6.1.3	Pretest Readiness Meeting .....	2.2-95
6.2	Test Certification Board (TCB) .....	2.2-96
6.3	Data Discrepancy (DD) Reporting And Resolution Procedures .....	2.2-97
6.4	Data Discrepancy (DD) .....	2.2-97
6.5	Non Conformance Report (NCR) .....	2.2-98
7.0	<b>TEST DOCUMENTATION</b> .....	2.2-100
7.1	SSM/ST Documentation .....	2.2-100
7.1.1	Manual and Automated Test Procedures .....	2.2-100
7.1.2	Technical Instruction .....	2.2-102
7.1.3	Operations Order .....	2.2-103
7.1.4	Master Procedure List .....	2.2-104
7.1.5	Test Procedure (TP), Technical Instruction (TI), And Supplemental Technical Instruction (STI) Logs .....	2.2-104
7.1.6	Log Of Operations (LOO) .....	2.2-104
7.1.7	Operations Order (OPO) Section .....	2.2-104



8.0	AUTOMATED TEST METHODOLOGY.....	2.2-106
8.1	Glossary.....	2.2-106
8.2	Power-On Test.....	2.2-112
8.3	Functional Test.....	2.2-113
8.4	Confidence Tests.....	2.2-113
8.5	Environmental Tests.....	2.2-114
8.6	Health And Status Checks.....	2.2-114
8.7	Special Tests.....	2.2-114
8.8	Science Data Processing.....	2.2-115
8.9	Real-time Software.....	2.2-115
8.10	Test Control.....	2.2-115
8.11	Data Compression.....	2.2-116
8.12	Data Analysis.....	2.2-116
9.0	SUPPORT EQUIPMENT.....	2.2-118
9.1	SSM/ST Contractor GSE/STE.....	2.2-118
9.1.1	SSM/ST Contractor Electrical GSE/STE.....	2.2-118
9.3	Multi-use Mission Support Equipment (MMSE).....	2.2-118
9.3.1	Payload Canister.....	2.2-118
9.3.2	Canister Transporter.....	2.2-119
9.3.3	Transporter Instrumentation Set.....	2.2-119
9.3.4	Environmental Conditioning Unit.....	2.2-119
9.4	Logistics.....	2.2-119
9.5	TDRSS/NASCOM Support.....	2.2-119
9.6	Space Support Equipment (SSE).....	2.2-120
9.7	Support Equipment Verification.....	2.2-120
10.0	FACILITIES.....	2.2-122
10.1	STAVF.....	2.2-122
10.1.1	VATA.....	2.2-122
10.1.2	SI Receiving And Inspection (R&I) Depot.....	2.2-122
10.1.3	Acoustic Test Cell.....	2.2-123
10.1.4	Thermal Vacuum (TV) Chamber.....	2.2-123
10.1.5	Staging Area.....	2.2-123

REPLACEMENT

**LIST OF FIGURES**

<b><u>Figure</u></b>	<b><u>Title</u></b>	<b><u>Page</u></b>
1-1	Verification Schedule and Sequence of Events.....	2.2-17
2-1	HST Physical Relationships.....	2.2-0

**EXAMPLE**

LIST OF ACRONYMS

A&V	Assembly and Verification
ACE	Actuator Control Electronics
AD	Aperture Door
ADP	Acceptance Data Package
AFQA	Air Force Quality Assurance
AFPRO	Air Force Plant Representative Office
AS	Aft Shroud
ATP	Automated Test Procedure
AWI	Assembly Work Instruction
BAe	British Aerospace
BASD	Ball Aerospace Systems Division
BER	Bit Error Rate
BOB	Break Out Box ,
CAB	Corrective Action Board
CART	Condition of Assembly for Release and Transfer
CCA	Configuration Control Article
CCB	Configuration Control Board
CCC	Charge Current Controller
CDU	Command Data Unit
CEI	Contract End Item (Specification)
CF	Control File
CFE	Control Functional Equipment
CG	Center-of-Gravity
CI	Configuration Inspection
CITE	Cargo Integration Test Equipment
CLF	Control and Limit File
CN	Change Notice (Contractual)
CPU	Central Processing Unit
CRT	Cathode Ray Tube
CSS	Course Star Sensor
CTV	Compatibility Test Van
D/A	Digital-to-Analog
DCB	Design Change Board
DCE	Deployment Control Electronics
DD	Data Discrepancy
DF-224	ST On-Board Computer
DIU	Data Interface Unit
DMA	Direct Memory Access
DMS	Data Management System
DMU	Data Management Unit
D-Model	Development Model (SA Wing)
DPC	Digital Processing Console
DR	Data Requirement
DSN	Deep Space Network
DT	Data Team
DTL	Data Team Leader
ECA	Electronic Control Assembly
ECP	Engineering Change Proposal
EDB	Engineering Data Base
EJRT	Engineering Job Release Ticket
EM	Engineering Model

EMC	Electromagnetic Compatibility
EO	Engineering Order
EPS	Electrical Power Subsystem
ES	Equipment Section
ESA	European Space Agency
ESD	Electro Static Discharge
ESTE	Electrical Special Test Equipment
ESTR	Engineering/Science Data Tape Recorder
EVA	Extra Vehicular Activity
FGE	Fine Guidance Electronics
FGS	Fine Guidance Sensor
FHST	Fixed Head Star Tracker
FOC	Faint Object Camera
FOS	Faint Object Spectrograph
FOSR	Flexible Optical Solar Reflector
FPA	Focal Plane Assembly
FPS	Focal Plane Structure
FRR	Flight Readiness Review
FS	Forward Shell
FSS	Flight Support System
GFE	Government-Furnished Equipment
GSE	Ground Support Equipment
GSFC	Goddard Space Flight Center
GSTDN	Ground Space Flight Tracking and Data Network
HEPA	High Efficiency Particulate Air (Filter)
HGA	High Gain Antenna
HGAS	High Gain Antenna System
HRS	High Resolution Spectrograph
HSP	High Speed Photometer
IBM	International Business Machines Corporation
I&C	Instrumentation and Communication Subsystem
ICD	Interface Control Document
I/F	Interface
IR	Infrared
ISS	OTA/SSM Integration Support Stand
JI	Job Instruction
JPA	Job Package Authorization
JPL	Jet Propulsion Laboratory
JSC	Johnson Space Center
KA	Keep Alive
KSC	Kennedy Space Center
LAC	Lockheed Aircraft Corporation
LAPSS	Large Area Pulsed Solar Simulator
LB	Log Book
LBCR	Log Book Change Request
LCC	Launch Control Center (KSC)
LEO	Liaison Engineering Order
LGA	Low Gain Antenna
LMSC	Lockheed Missiles & Space Company, Inc.
LOO	Log of Operations
LS	Light Shield
LSA	Light Shield Assembly
MA	Multiple Access
MCC	Mission Control Center (Houston)

MCE	Monitor and Control Electronics
MGSE	Mechanical Ground Support Equipment
MLI	Multi-Layer Insulation
MMSE	Multi-Use Mission Support Equipment
MPL	Master Procedure List
MRB	Material Review Board
MRBSR	Material Review Board Standard Repair
MSFC	Marshall Space Flight Center
MSS	Magnetic Sensing System
MSTE	Mechanical Special Test Equipment
MTP	Master Test Procedure
N/A	Not Applicable
NASCOM	NASA Communications Network
NCR	Non-Conformance Report
NCRS	Non-Conformance Report Supplement
NOCC	Network Operations Control Center (GSFC)
OBC	On-Board Computer (DF-224)
OBSW	On-Board Software
OCE	Optical Control Electronics
OCS	Optical Control Subsystem
OEXO	Oven Controlled Crystal Oscillator
OPF	Orbiter Processing Facility
OPO	Operations Order
ORI	Operational Readiness Inspection
ORR	Operational Readiness Review
ORU	Orbit Replaceable Unit
OTA	Optical Telescope Assembly
OV	Orbital Verification
PA	Product Assurance
PAMSCO	Program Article Master Schedule Commitment
PBM	Power Bus Module
PCR	Payload Changeout Room
PCS	Pointing Control Subsystem
PCSS	PCS Simulator
PCU	Power Control Unit
PDM	Primary Deployment Mechanism (SA)
P-E	Perkin-Elmer
PGHM	Payload Ground Handling Mechanism
PI	Principal Investigator
PIP	Payload Integration Plan
PIT	Processor Interface Table
POCC	Payload Operations Control Center (Part of STOCC)
PRCS	Primary Reaction Control System
PSEA	Pointing and Safe Mode Assembly
QA	Quality Assurance
QE	Quality Engineering
REE	Responsible Equipment Engineer
RF	Radio Frequency
RIU	Remote Interface Unit
RMGA	Retrieval Mode Gyro Assembly
RMS	Remote Manipulator System
RSS	Rotating Service Structure
RSU	Rate Sensing Unit
RTC	Real-Time Command

RWA	Reaction Wheel Assembly
R&I	Receiving and Inspection
SA	Solar Array
SADA	Solar Array Drive Adapter
SADE	Solar Array Drive Electronics
SASCOE	Solar Array Special Checkout Equipment
SATS	Spacecraft Automated Test System
SCAMA	Switch, Conferencing and Monitoring Arrangement
SCCER	System Command and Control Equipment Rack
SDR	Software Discrepancy Report
Sci	Science Institute
SDM	Secondary Deployment Mechanism
SI	Scientific Instruments
SI C&DH	Scientific Instrument Control and Data Handling
SIFIG	SI&FGS Installation GSE
SIVS	Spacecraft Integrated Verification SET
SMC	Safe Mode Computer
SMI	Safe Mode Interface
SMRB	Senior Material Review Board
SOIB	SCCER to OTA Interface Box
SPA	Solar Panel Assembly
SPG	Single Point Ground
SSA	S-Band Single Access
SSC	Science Support Center (part of STOCC)
SSE	Space Support Equipment
SSM	Support Systems Module
ST	Space Telescope
STS	Space Transportation System
STAVF	ST Assembly and Verification Facility
STE	Special Test Equipment
STI	Supplemental Technical Instruction
STOCC	ST Operations Control Center (GSFC)
STOL	System Test Operations Language
STPOCC	ST Payload Operations Control Center
STVT	ST Verification Team
STVTL	ST Verification Team Leader
SWAD	Shop Work Authorizing Document
TAG	Two Axis Gimbal
TBD	To Be Determined
TBR	To Be Resolved
T/C	Test Conductor
TCB	Test Certification Board
TCC	Test Control Center (LMSC)
TCS	Thermal Control Subsystem
TDRS	Tracking and Data Relay Satellite
TDRSS	Tracking and Data Relay Satellite System
TDT	Test Data Team ,
TDTL	Test Data Team Leader
TELB	Test Engineering Log Book
TI	Technical Instruction
TOY	Time-of-Year
TP	Test Procedure
TPCN	Test Procedure Change Notice
T/S	Troubleshooting

TV	Thermal Vacuum
UAI	Use-As-Is
UAS	Urgent Action Survey
VAB	Vehicle Assembly Building
VAP	Verification and Acceptance Program
VAPCS	VAP Computer System
VATA	Vertical Assembly and Test Area
VATS	Vertical Assembly Test Stand
VAX	Virtual Address Extension
VDS	Vehicle Dynamics Simulator
VICT	Verification and Interface Compatibility Test
VMS	Virtual Memory System
VPF	Vertical Processing Facility
VPHD	Vertical Payload Handling Device
VRCS	Vernier Reaction Control System
VRSD	Verification Requirements and Specifications Document
VSWR	Voltage Standing Wave Ratio
VIDA	Verification Team Data Analyst
VTOT	Verification Team Operating Instructions
WBR	Wideband Recorder
WF/PC	Wide Field/Planetary Camera

**EXAMPLE**

## 1.0 INTRODUCTION

This document is a Verification Plan which describes how the flight hardware and software will be qualified and tested in compliance with the Verification Requirements and Specifications Document (VRSD). Embodied within this plan will be a narrative of how several NASA centers and Associated Contractors will have to interact in order to produce an effectively managed Verification operation.

This document is further intended to be an overall Verification Plan. It is not intended to be:

1. As detailed as test procedures,
2. A contractual change document,
3. A scheduling instrument,
4. Timelines and manloading document,
5. An ICD (Interface Control Document),
6. An organizational control document.

Therefore, block diagrams, layouts, tables, lists, etc., will be as up to date as possible in nature and updated, if required.

The Verification schedule in Figure 1-1 will be updated as required.

Test Procedures/details, instrumentation lists, software details, facility power and wiring, facility detailed layouts, timelines, schedules, and other necessary detailed information that has to be maintained in a current status will exist in other documentation as referenced herein.

### 1.1 Scope

This plan defines the activity for the hardware qualification and acceptance testing. Involved in this total verification cycle will be the demonstration of the ground test software's ability to interface with the flight software through a highly automated (computer controlled) test complex.

This process is also intended to achieve compatibility between the flight software directives and the flight hardware responses, thus providing a completely integrated spacecraft. These activities will take place at the Assembly and Verification (A&V) Facility, and at the Operations Control Center.

This plan also describes the A&V organizations, support organizations, the Verification Team, the Test Certification Board (TCB), the participation of the Associate Contractors, Launch Site and the Operations Control Center. The Ground Support Equipment (GSE), Special Test Equipment (STE) and the facilities to support the A&V activities are also described. The methods, procedures and controls for performing the A&V are outlined to provide the Customer and Associate Contractors an overview of how the Contractor will integrate all elements into a Verification program.

### 1.2 Applicable Documents

The following documents are specifically referenced herein and are applicable to the extent referenced:

AV-01	Verification Plan
AV-02	SSM VRSD



MONTHS

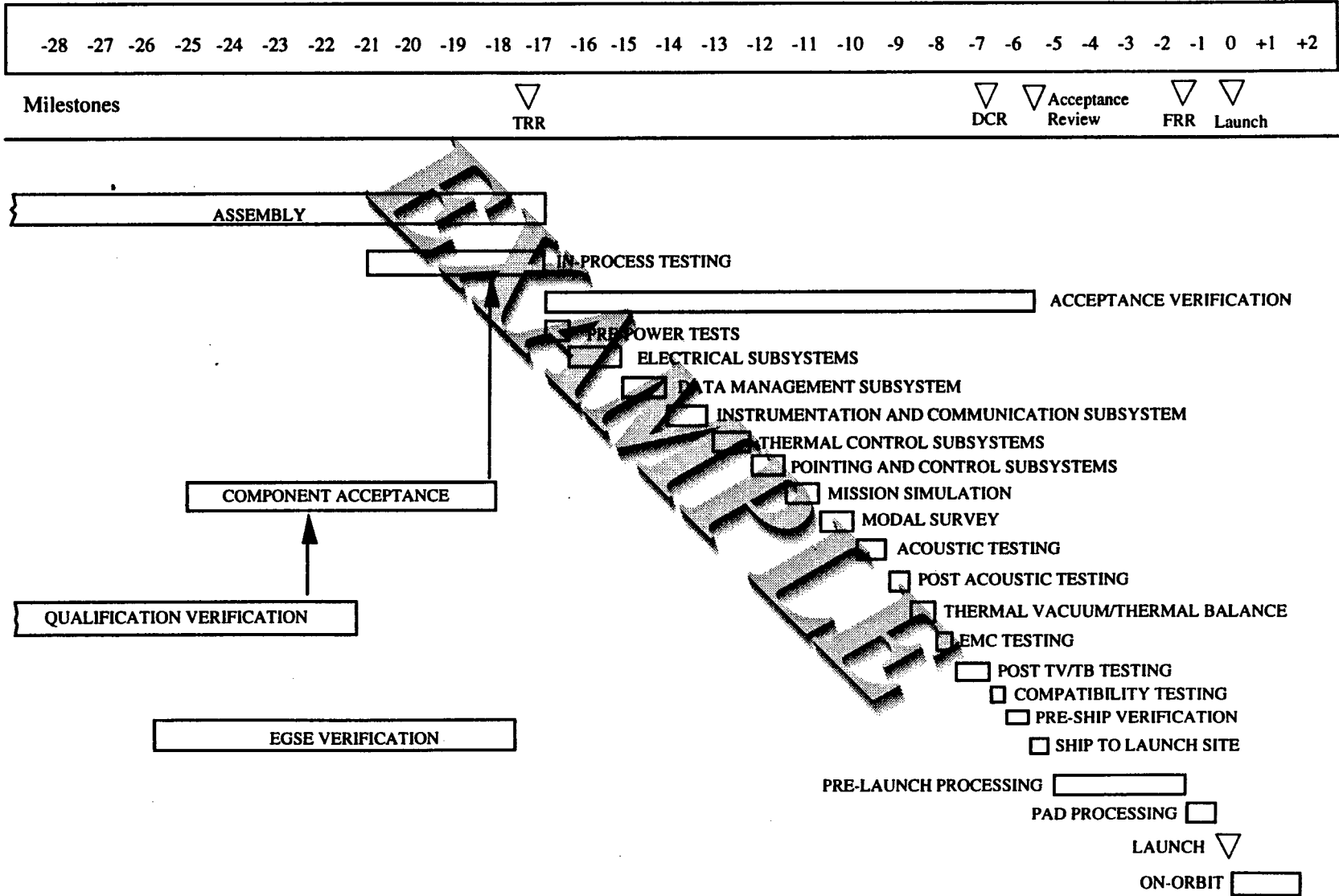

Figure 1-1 Verification Schedule and Sequence of Events  
2.2 - 17

MSFC/SAV1020	ST Verification Requirements and Specifications, Vol. I, ST Integration Site
SAV1021	ST Ambient Functional Test, VRSD
SAV1022	SI System Integration (SSM/ES-SI) Test, VRSD
SAV1023	ST Assembly Prepower, VRSD
SAV1024	ST Systems End-to-End, VRSD
SAV1025	ST Modal Survey, VRSD
SAV1026	ST EMC Test, VRSD
SAV1027	ST Acoustic Test, VRSD
SAV1028	ST TV/TB Test, VRSD
SAV1029	ST Pre-Ship Preparation, VRSD
SAV1040	ST Launch Site, VRSD
AV-07	ST Test Procedures
AV-08	ST Verification Report
CM-05	Acceptance Data Package
DM-01	ST Command List
DM-02	ST Instrumentation Program and Component List
DM-03	SSM/ST Ground Test Software
DM-04, Vol IV	ST Flight Software Verification Plan
DM-11	SSM/ST C&DH Software Interface Plan
DM-14	ST Engineering Telemetry Calibration List
LAC3605	Electrostatic Sensitive Hardware
LS-01	Logistics Plan
LS-03	ST Government Furnished Equipment Management Plan
OP-01, Vol I	ST Launch Site Operations Requirements
OP-04	ST Launch Site Operations Procedures (Off-line)
OP-05, Vol I	ST Launch Site Operation Procedures Input (On-line)
OP-05, Vol IV	ST Operations at STOCC Procedures Input
PA-01	ST Product Assurance Plan
PA-02	ST Contamination Control Plan
SE-09	Electromagnetic Compatibility Plan
LMSC/D796518	GSE/STE Instrumentation Schedule
ST ICD-01	OTA/SSM Interface Control Document
ST ICD-IOA	ST to SSE Interface Control Document
LMSC/D801396	GSE/STE Command List
LMSC/D801358	Engineering Data Base User's Guide
LMSC 4175751	GSE/STE Requirements Specification
LMSC/D792999	ST Environmental Test Instrumentation Plan
JSC 14009	Payload Integration Plan (Annex 8) - ST Launch Site Support Plan (K-DPM-11.5)

### 1.3 Document Maintenance And Control

This SAV1000B plan is a Level II document under MSFC control and maintained by LMSC. The project manager will control any changes to this document should they be required. Updates will be made on a page substitution basis and approved by the Level II Configuration Control Board (CCB).

## **2.0 DESCRIPTION OF THE HUBBLE SPACE TELESCOPE**

### **2.1 Deployment Mission**

The Hubble Space Telescope (HST) is a high quality optical 2.4 meter telescope system operating in earth orbit. The Space Shuttle will launch the HST into an approximate circular orbit of 320 nautical miles altitude.

HST removal from the payload bay begins with transfer of vehicle power and umbilical disconnect. The HST Operations Control Center, will configure the vehicle to minimize the battery Depth of Discharge (DOD) when the HST is switched to internal power. The vehicle is grappled using the RMS, the HST is switched on internal power, and external power is turned off, both controlled by the Standard Switch Panel. The umbilical and Payload Retention Latch Assemblies (PRLA) are disconnected remotely and the vehicle is removed from the cargo bay and oriented to allow crew observation of the Solar Array (SA) Deployment.

Solar Array Deployment activities are begun when the MCU and DCE power are turned on after RMS positioning of the HST for appendage deployment. The SA forward latches are released, and then the aft latches. The primary deployment mechanisms are actuated and both booms are deployed. After primary deployment is accomplished the initiation of secondary deployment is delayed for ten minutes to allow the arrays to warm. After secondary deployment is complete the arrays will be commanded to perform a series of small slews. Following verification of the SA slew capability, the High Gain Antenna (HGA) deployment begins. Gimbal Electronics Assembly (GEAs) are activated to a stable configuration thus providing positive control of the HGA slewing. Then the plus and minus HGA latches are released and the HGA masts deployed. The Reaction Wheel Assembly (RWAs) will be turned on, but no torque commands sent. The release of the HST occurs after Pointing Control System (PCS) initialization of draft mode (zero torque commands to RWA, MTE).

### **2.2 Systems Description**

The HST system consists of the Support Systems Module (SSM), the Optical Telescope Assembly (OTA), Solar Arrays (SA), Scientific Instruments (SI), and OTA equipment section. Various subsystems are an integral part of the HST and govern electrical power, pointing control, Instrumentation and Communications (I&C), solar array wings and control electronics, and thermal control. The physical relationships of the HST are shown in Figure 2-1.

The SSM will provide structural support, thermal control, electrical power, communications, data management, and pointing control in support of the OTA, OTA equipment section, SI, and SI Control and Data Handling (SI C&DH) module. The primary mode of communication for the HST will be through the Tracking and Data Relay Satellite System (TDRSS) to the HST Operations Control Center (STOCC).

The HST uses a Pointing Control Subsystem (PCS) to provide vehicle maneuvering during on-orbit operations, attitude-reference signaling, and attitude control and stabilization. These capabilities are implemented through PCS sensors, actuators and associated electronics, the On-Board Computer (OBC: DF-224), Fine Guidance Sensors (FGS), and support from other vehicle subsystems.

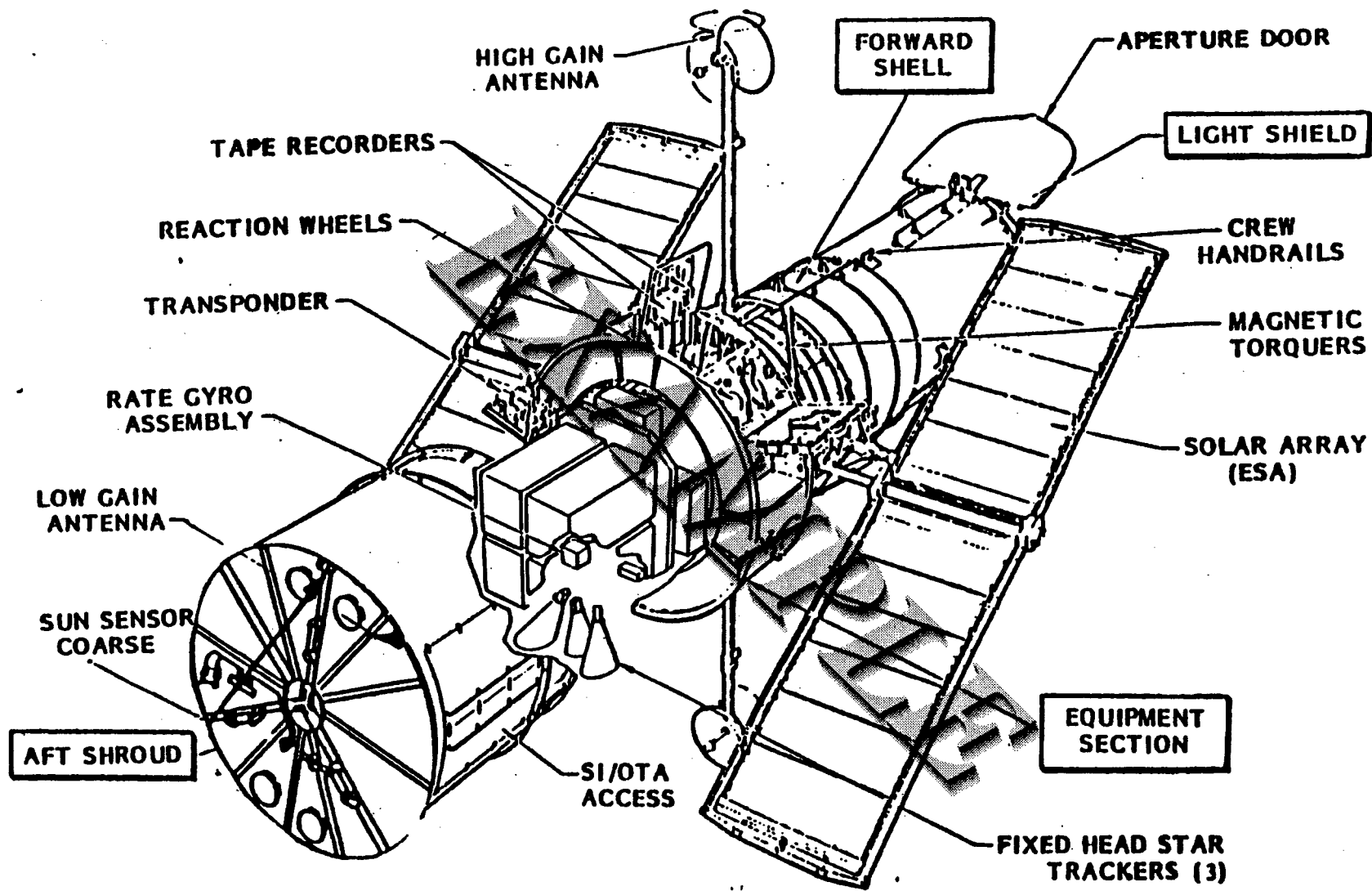

Figure 2-1 HST Physical Relationships

### 2.2.1 Support Systems Module (SSM)

The SSM provides structural support, thermal control, pointing control, data management, communications, and electrical power to support the OTA and SIs with associated control and data handling.

The structure consists of aluminum semi-monocoque cylinders which house the telescope and Scientific Instruments, annular box sections which house the spacecraft electronics and an Aperture Door (AD) for light and contamination control.

The Support Systems Module Equipment Section (SSM-ES) is an annular section containing the spacecraft electronic and control equipment. This section serves as the structural support for the Optical Telescope and Scientific Instrument assembly. It also transfers launch loads from the Hubble Space Telescope to the Shuttle Orbiter via the main trunnions and the keel fitting. A 150° toroidal equipment section just forward of the main equipment section houses Optical Telescope Assembly electronics. Both the Support Systems module and Optical Telescope Assembly equipment sections have compartment doors to allow ready access for ground and on-orbit maintenance. Many spacecraft electronic boxes are designed for on-orbit replacement.

The Scientific Instruments, located behind the Telescope's primary mirror, are protected from sunlight and its thermal effects by a cylindrical shroud and an bulkhead. Large doors in the Aft Shroud (AS) provide maintenance access to the Scientific Instruments and pointing control subsystem sensors for ground and orbital replacement.

The axially-mounted SI's are each retained by one passive and two active latches. The radial SI (WF/PC) is retained by two guide pins, an active latch, and an active cable harness connector mechanism. The Fine Guidance Sensor (FGS) Modules are each retained by three guide pins and an active latch. All active latches and connectors are driven by long threaded shafts, which are automatically locked by a spring-loaded spline latch. Proper latch positions and shaft locks are verified prior to shipment.

Thermal control is accomplished mostly by passive means, utilizing selective thermal coatings, and multi-layer insulation. Supplemental heaters are required for the primary mirror, focal plane structure, the Scientific Instruments, and where close temperature control is required. Heat pipes are utilized by two instruments (FOS, WF/PC). Each heat pipe contains about a teaspoonful of ammonia. Analysis shows no toxic or corrosive hazards.

Space Telescope's Pointing Control System is an operationally critical design element since it must slew the spacecraft from one target region of the sky to the next and maintain stability of .007 arc-sec for period of up to 24 hours. To do this, the spacecraft computer calculates required torque from optical and inertial sensor error signals and commands four large reaction wheels, to slew the spacecraft and to point it at selected objects. Four magnetic torquers are commanded by the computer to react against the Earth's magnetic field to provide torque's necessary to keep reaction wheel speed within operating limits.

Two fine guidance sensors provide pitch, yaw and roll error signals as they "guide" on two reference stars of known magnitude and posit on. A third fine guidance sensor is a redundant element for pointing control and will be used as a Scientific Instrument for astrometric observations. Other essential elements of the pointing control subsystem include rate gyros, fixed head star trackers, sun sensors and the electronics associated with each sensor element. The rate gyros provide inertial reference guidance error signals during slew maneuvers and also assist the

Line guidance sensors during guide star acquisition. Fixed head star trackers are used for initial acquisition of large star fields and re-acquisition whenever guide star references are lost.

The Data Management Subsystem and its central computer serve as the nervous system and brain for Hubble Space Telescope. The computer is a triply redundant device which processes and controls all software subroutines required for operation of spacecraft systems. Most commands are routed through or stored in and executed from the computer. A data-bus transmits these commands to the user subsystems and returns data to the computer, recorders, and transmitters.

Science data is processed through a Scientific Instrument Control and Data Handling (SIC & DH) Unit. This unit has its own computer which accepts, decodes and distributes unique Scientific Instrument commands. It also serves as the central point for formatting scientific data to be recorded or directly transmitted to the ground. The Science Instrument output data represents the principal product of each observation. These data go to the ground station and are then transmitted to the observer for evaluation.

The Instrumentation and Communications (I&C) Subsystem acquires on-board engineering data, transmits it to the ground and receives up-linked commands which are then processed and executed by the data management subsystem. Communications between the ground and the spacecraft will be relayed via two synchronous orbit Tracking and Data Relay Satellite Systems (TDRSS). A multiple access mode communicates engineering data, commands, and tracking data for about 70 minutes of the spacecraft's orbital period. Twenty minutes of single access mode capability per orbit down-links scientific information and recorded engineering data.

The Electrical Power Subsystem (EPS) provides power generation, energy storage, conditioning, control, and distribution. The spacecraft's four kilowatts of energy come from two flexible unfurled Solar Arrays (SA) supplied by the European Space Agency (ESA). The arrays are unfurled while the HST is on the Remote Manipulator System (RMS) just prior to deployment from the Orbiter and are retracted prior to retrieval. Both arrays rotate about the pitch axis during slew maneuvers to maintain solar cell surface normal to the Sun during observations. The Space Telescope utilizes an average of 2.3 kW for operation of all subsystems and instruments. Energy is stored in six 60 amp-hour nickel-cadmium batteries and "bus regulated" power is supplied to all users at a nominal 28 volts.

Subsystems that are safety-critical for operations at KSC are the Electrical Power Subsystem (EPS), the Instrumentation and Communication Subsystem (I&C), and the Structures and Mechanisms Subsystem (S&M).

### **2.2.2 Optical Telescope Assembly (OTA)**

The OTA system consists of a 2.4m Ritchey-Chretien Optical System, its associated support and baffle structures, and a focal plane assembly consisting of fine guidance and wavefront quality sensors. It also includes a precision structure that maintains OTA alignment to the  $f/24$  image as well as providing support for five SIs. The OTA operates in a spectral range from  $1.2 \times 10^3$  angstroms to  $1.0 \times 10^7$  angstroms, and can detect stellar objects of a visual magnitude ( $m_v$ ) of 27 or brighter. The primary mirror is mounted in a titanium cell by an all-mechanical, positive registration constraint system. Glass-to-metal interface stresses are compressive regardless of the loading direction. Strip heaters are located behind and around the edges of the mirror, on the focal plane structure, and on the Fine Guidance/Optical Control subsystems to maintain the temperature at  $70^\circ\text{F} + 2^\circ\text{F}$ . This precludes any optically significant thermal effects between laboratory and on-orbit environments.

The secondary mirror, located 193 inches forward of the primary mirror, is 14 inches in diameter. The secondary mirror mount has a five-axis adjustment capability for establishing alignment after on-orbit deployment and for periodic realignment if required.

### **2.2.2.1 Optical Telescope Assembly Equipment Section (OTA-ES)**

Electronics for the fine guidance sensors, Optical Telescope Assembly thermal control and power distribution are located in the 150° toroidal Equipment Section attached to the forward shell (FS) and the forward face of the Support Systems Module's Equipment Section on the -V<sub>3</sub> (cold) side of the spacecraft. This section is slotted at the forward end for the HGA attachment to the FS.

### **2.2.3 Fine Guidance System**

The Fine Guidance System includes the Fine Guidance Sensor (FGS) and the associated Fine Guidance Electronics (FGE) necessary to provide error signals to the HST PCS. The three FGSs are located radially around the outside edge of the OTA. Starting with an initial error as large as +30 arc sec, the FGS generates attitude error signals during fine pointing about two orthogonal axes contained in a plane normal to the HST V1 axis. The PCS then controls torques on the HST to null the pointing error and thus stabilize the target image, to within 0.007 arc sec about the selected Line of Sight (LOS). The sensor is also used to make repeatable measurements of the angular distance between stars within its Field of View (FOV) with an accuracy within +0.002 arc sec.

The FGS receives light from a pair of stellar sources (13 m<sub>v</sub> or brighter) and detects motions about three axes relative to these sources. The FGS is the most accurate and the most complicated of the sensors, and measures the angular position of a star. It uses the principle of interferometry to obtain an error signal that is accurate to fractions of an arcsecond. Two of the three FGSs are used by the PCS to perform stellar pointing or low-rate scanning. These sensors are used for attitude correction of the telescope Line-of-Sight (LOS). The sensor that is not used for telescope pointing, which can be any one of the three FGS sensors, will be available for astrometric measurement.

The FGS can be used in three astrometric modes: primary astrometric targets stationary with respect to the FOV; primary targets moving with respect to the FOV; and a scan to obtain the transfer function for each object in the FOV.

### **2.2.4 Scientific Instruments (SI)**

Five independent SIs are employed on the HST to achieve a set of specified scientific objectives. The SIs consist of a number of interconnected subsystems and components, including standardized enclosures. None of the SIs contain significant stored energy. The SIs assigned to the HST include:

- Faint Object Camera (FOC)
- High Resolution Spectrograph (HRS)
- High Speed Photometer (HSP)
- Faint Object Spectrograph (FOS)
- Wide Field/Planetary Camera (WF/PC)

#### **2.2.4.1 Faint Object Camera (FOC)**

The FOC was designed to utilize the full optical performance of the HST, reaching the faintest limiting magnitudes (as faint as 28th magnitude) and highest angular resolution possible.

Two detectors are provided, each consisting of an image intensifier tube coupled to a camera tube by a lens. The detectors are supported by a Carbon Fiber Reinforced Epoxy (CFRP) optical bench which also supports the shutter mechanism, filter wheels, folding mirrors, and spectrograph. The video signals are amplified to logic levels and are analyzed in a pattern recognition circuit intended to discriminate between ionic noise and photon events. Accepted events are accumulated in a data store in time periods up to 10 hr. and then telemetered to ground on demand. Close thermal control with active heating is necessary to limit image drift during the exposure time. Electronic counters are provided to connect the 2&V supply bus to 28Vac for internal distribution. The detectors use 40kV and 12kV supplies and a permanent magnet to provide the required electro-optical gain. An on-board computer, redundant data handling units [SI Control and Data Handling (SI C&DH)], and additional electronic boxes are provided to operate the mechanisms and thermal control.

#### **2.2.4.2 High Resolution Spectrograph (HRS)**

The HRS is designed to take high resolution spectral images in the ultraviolet region (105 NM to 320 NM) with spectral resolving powers  $R = 2 \times 10^5$  (equivalent to velocities of 15 km/sec), and in the region 110 NM to 320 NM with  $R = 1.2 \times 10^5$  (corresponding to 2.5 km/sec). These characteristics represent a major improvement over the performance of previous generations of ultraviolet space observatories such as Copernicus and the International Ultraviolet Explorer (IUE). Objects one thousand times fainter than those detectable by these observatories will be observable. The high spectral resolution will enable sharp-lined spectra to be studied.

The HRS is installed in a standard SI axial module; Heat pipes are used between the two Digicon detectors to isothermalize them, thus allowing a rapid change in detectors between successive observations. The overall thermal control system uses a combination of heaters, insulated walls facing other SIs, and radiating walls facing the aft shroud.

#### **2.2.4.3 High Speed Photometer (HSP)**

The HSP consists of a number of image dissectors, their associated electronics, and a focal plane aperture mask and filter plate. The operating principle is that the face plate in the focal plane contains a number of filter strips, each having a pair of three different aperture stops. Portions of some strips are coated with a polarizing film in four orientations at 45 deg, enabling linear polarization to be measured. The image dissector aperture is determined by the largest field stop (0.8 mm diameter, corresponding to 2.9 arc sec diameter). The other apertures are 1.4 arc sec and 0.7 arc sec in diameter. Changing from one aperture to another is effected by moving the HST as a whole. The image dissectors can be commanded to receive photoelectrons from any one of the filter-diaphragm-polarizer combinations available.

The HSP is designed to operate in a temperature range of -15°C to +35°C (5°F to 95°F). Thermal control is passive; i.e., operating power is dissipated by radiation to the HST aft shroud.

#### **2.2.4.4 Faint Object Spectrograph (FOS)**

The FOS is designed to obtain spectra of astronomical objects at the faintest possible limiting magnitude in the ultraviolet and visible wavelengths. The spectrograph covers a broad spectral range and is intended for spectroscopy primarily at modest spectral resolution. The spectral profiles of broad emission and absorption features, and continuum flux distributions are to be observed in both extended and point sources.

The FOS is installed in a standard axial SI module. Heat pipes carrying heat away from the Digicon detectors to radiators on the FOS module surface satisfy the thermal control requirements. The heat



is radiated to the HST aft shroud and dissipated into space. The system is cold-biased, and thermostatically-controlled heaters maintain the optical bench within operational temperature limits.

#### **2.2.4.5 Wide Field/Planetary Camera (WF/PC)**

The WF/PC is a high resolution imaging system that incorporates both wide field and planetary cameras. The detectors provide a spectral range into the far ultraviolet ( $1.160 \times 10^3$  angstroms) as well as into the near infrared ( $1.150 \times 10$  angstroms). Also included is a filter carousel carrying up to 50 spectral filters, polarizers, or transmission gratings.

The WF/PC is the only radial SI and is installed in a different envelope than the other four SIs. Thermal control of the WF/PC includes heat pipes that conduct heat from the image detectors to an external radiator that forms part of the external surface of the aft shroud. An annular gap around the radiator (with a light seal) provides a pressure vent for the aft shroud during ascent and reentry.

#### **2.2.4.6 Scientific Instrument Control and Data Handling (SI C&DH) Module**

The SI C&DH module provides the command and data interface between the SIs and the SSM. The SI C&DH module is an end item consisting of components that interface with the individual SIs for operational control, monitoring, and formatting SI engineering and scientific data.

#### **2.2.5 Solar Array (SA)**

The SA consists of two wings each comprising two flexible solar cell blankets deployed/retracted by mechanisms. The Primary Deployment Mechanism (PDM) deploys the array wing from its stowed position at the side of the SSM to a position perpendicular to the spacecraft body. The Secondary Deployment Mechanism (SDM) deploys the blankets from a rolled up configuration after the PDM has deployed the wings. Motor drive power for deployment or retraction and for orientation of the array is supplied by electronic boxes within the SSM via a harness in the SA system. The boxes are: the Deployment Control Electronics (DCE) which deploy the PDM and SDM, and the Solar Array Drive (SAD) Electronics (SADE) which orients the array as required. Power is generated in 20 subassemblies of solar cells known as Solar Panel Assemblies (SPA), and is fed via 20 separate circuits through isolating diodes in the diode boxes (one for each wing) and then to the SSM power system. To prevent bearing damage by brinelling during launch, the SAD Mechanism (SADM) bearings are off-loaded. Before operation of the SADM, it is necessary to release this load, which is accomplished by a one-shot device known as the Off Load Device (OLD). Redundant drive circuits are provided and, as a last resort, provision is made for astronaut intervention to enable release of the CLD, orientation and locking of the array, deployment or retraction of the blankets, deployment or retraction of the arm, and jettison of one or both wings.

### **2.3 Subsystems**

#### **2.3.1 Electrical Power Subsystem (EPS)**

Electrical power is provided to the various HST systems by the EPS. The EPS consists of six type-44 nickel-cadmium batteries, Charge Current Controllers (CCC), two solar array wings and associated electronics control assemblies, one power control unit and four power distribution units, cabling and connectors, two umbilical connectors, and two test connectors. Electrical power is generated by the solar arrays and stored in the batteries for use during non-sunlight on-orbit operations.

### **2.3.1.1 Batteries**

The batteries selected for use in the HST electrical systems are type-44 nickel-cadmium battery assemblies. They are comprised of sealed cells, and are long-life, rechargeable batteries requiring no maintenance. The battery configuration consists of 23 series-connected rectangular cells. Each cell is enclosed in a type-304L (corrosion resistant) steel case that is 0.025-inch thick. The electrolyte is a limited quantity solution of 30 percent potassium hydroxide (KOH) and 70 percent distilled water, resulting in a specific gravity of 1.30.

Sealed cells are designed to operate under normal conditions at low gas pressures from 0 psig to 100 psig. Each cell is provided with a resealable safety vent. The safety vent is designed to open (if such pressures were to occur), release this pressure within the battery case, and then automatically close. The vent system protects the cell by opening if the pressure reaches 200 psig  $\pm$  25 psig, and reseals at 100 psig. The battery case is designed with a pressure relief valve set to relieve pressures at 15 psig  $\pm$  5 psig.

The batteries will be located in the SSM equipment section. Three batteries will be installed on the access door of Bay 3 and three batteries will be installed on the access door Bay 2. Each battery has internal heaters to maintain the battery temperature within a range of 20°F to 60°F.

### **2.3.1.2 Battery Protection and Reconditioning Circuit (BPRC)**

The BPRC shall be capable of providing protection to the battery by ensuring that no cell reverses polarity during reconditioning. During normal operation the BPRC circuit is isolated from the cells by reverse biasing diodes. When the battery discharges, cells at the lower state of charge allow Schottky diodes to become forward biased and the BPRC for that cell begins to support the battery output voltage. If a cell fails to maintain a charge (collapsed cell) the BPRC supports that cell's voltage and provides the path for the battery current so that the battery will continue to provide its share of the vehicle load.

### **2.3.1.3 Charge Current Controller (CCC)**

HST battery charging, both on-orbit and for test of the charging system at KSC, is controlled by solid-state CCCs. There are six CCCs, each dedicated to a specific battery. Each CCC is essentially a multi-level voltage-temperature control of battery charging through two independent channels. Each can connect or disconnect either a portion or all of its solar array (or GSE) charging source by energizing or de-energizing its dedicated relays in the Power Control Unit (PCU). No charging will occur above 87°F.

### **2.3.1.4 Power Distribution Unit (PDU)**

The PDU controls the power going from the main buses to the using equipment. The large number of electrical circuits needed for the SSM, including complete redundancy, requires that the power distribution be segregated into four separate units. The PDU design includes diode blocking to provide power isolation, fusing to protect against fault current in one subsystem propagating a failure into another, and instrumentation necessary to monitor the health of the EPS. Fuses for orbital replaceable equipment are contained in three replaceable fuse plugs on each PDU.

### **2.3.1.5 Power Control Unit (PCU)**

The PCU provides the power interface between the solar arrays, the six flight batteries, and the four PDUs. The PCU provides redundant, unregulated power buses with switching capability for

isolating the A, B, and C diode buses in the event of a short circuit. Switching is also provided for reconditioning the batteries on-orbit. It also provides an interface between the test plug (located in +V<sub>2</sub> trunnion bay of the SSM equipment section) and the batteries for trickle-charging during ground testing. The interface between the umbilical power wiring and the main bus is in the PCU.

### **2.3.2 Instrumentation and Communications (I&C) Subsystem**

The I&C subsystem provides the HST SSM with a capability to receive commands from the ground and transmit data through TDRSS. All RF-commandable functions (including RF transmission or appendage deployment) require a predetermined series of multiple-bit digital commands for activation. This precludes inadvertent activation of any function. A capability to interface directly with the NASA Ground Spaceflight Tracking and Data Network (GSTDN) is also provided. The I&C subsystem includes all onboard equipment required to complete the communication loop with the HST.

Hardware in the instrumentation subsystem includes the Instrumentation Control Unit (ICU), temperature sensors, and signal conditioning electronics not incorporated in other subsystem equipment units. Communications hardware includes Multiple Access (MA) transponders, S-band Single-Access (SSA) transmitters, antennas and pointing system, coaxial cables and waveguides, a circulator switch, RF multiplexers, RF transfer switches, diplexers, and RF switches.

#### **2.3.2.1 Instrumentation Control Unit (ICU)**

The ICU provides electrical power control and signal conditioning for the numerous temperature sensors. Temperature sensors are mounted within the ST to provide continuous monitoring of vehicle health. The ICU is located in bay 8 of the SSM equipment section.

#### **2.3.2.2 Multiple Access (MA) Transponder**

The MA transponder consists of an S-band receiver, command detector, and a 5W transmitter capable of TDRSS service at the TDRSS forward link (TDRSS-to-HST) frequency of 2106.4 MHz (nominal) and a return link (HST-to-TDRSS) frequency of 2287.5 MHz (nominal). The MA transponder is also compatible with the NASA GSTDN. Diplexers are included as part of the MA transponder system. The two MA transponders are located on the comm tray in bay 5 of the SSM equipment section.

#### **2.3.2.3 S-Band Single Access (SSA) Transmitter**

Two SSA transmitters provide a communication return link from the HST to TDRSS. The transmitter operates at a frequency of 2255.5 MHz (nominal) with a power output of more than 13W. The SSA transmitters are located on the comm tray in bay 5 of the SSM equipment section.

#### **2.3.2.4 Antennas and Pointing System**

Two High Gain Antennas (HGAs) transmit science data and engineering telemetry to TDRSS. The HGAs are of a paraboloidal design, mounted on retractable masts, and installed on the +V<sub>3</sub> and -V<sub>3</sub> vehicle axes. A two-axis gimbal pointing system is located at the ends of each deployable mast and is controlled by the antenna pointing system gimbal electronics. The HGA pointing system can accept orientation commands from the STOCC with the SSM in the safe mode.

Two conical spiral Low Gain Antennas (LGA) receive specified ground commands and transmit specified engineering telemetry during deployment, retrieval (outside Orbiter bay), and contingency

operations. The LGAs are used with the MA transponder for a forward link, but are not used as transmitters during normal operations. The two LGAs are mounted at opposite ends of the SSM, approximately 180 deg apart. The LGAs operate in the 2100 MHz to 2300 MHz frequency range.

### **2.3.2.5 Circulator Switch**

The circulator switch allows the communications subsystem to switch between either MA transponder receivers. The RF circulator switch is activated by STOCC commands. The circulator switch is located on the comm tray in bay 5 of the SSM equipment section.

### **2.3.2.6 RF Multiplexer**

The RF Multiplexer combines the RF output of one MA transmitter (engineering data) through transfer switch H11 and either RF switch, with the RF output of one SSA transmitter (science data), through transfer switch H12, and routes the combined RF signal to one of the HGA. There are two RF multiplexers, which are redundant, as each multiplexer can receive inputs from any one of the two MA transmitters and from any one of the two SSA transmitters, through the two transfer switches. Both RF multiplexers are located on the comm tray in bay 5 of the SSM equipment section.

### **2.3.2.7 RF Switches**

Each RF switch receives the RF output of transfer switch H11. Each RF switch routes the signal to a Diplexer (LGAs) or to a multiplexer (HGAs). The two RF switches are located on the comm tray in bay 5 of the SSM equipment section.

### **2.3.2.8 RF Transfer Switches**

The RF transfer switch will route the signal from either MA transmitter to either RF switch. No. H12 RF transfer switch will route the signal from either SSA transmitter to either HGA Multiplexer. The two RF transfer switches are located on the comm tray in bay No. 5 of the SSM equipment section.

### **2.3.2.9 Diplexers**

Diplexers are part of the MA transponder units but are mounted separately on the comm tray in bay 5. Each routes incoming signals from the LGAs to a common RF circulator switch, and routes outgoing signals from either RF switch to the respective LGA, and may do both simultaneously.

### **2.3.2.10 Coaxial Cables and Waveguides**

Standard coaxial cables and waveguides interconnect the various communications hardware.

## **2.3.3 Structures**

The HST SSM provides the structural support to mount components of the SSM subsystems and other structural elements. Major structural elements of the SSI include the SSM Equipment Section (SSM-ES), the Forward Shell (FS), the Light Shield (LS), and the Aft Shroud (AS). The aft shroud includes the Aft Bulkhead (AS/AB).

### 2.3.3.1 SSM Equipment Section

The SSM Equipment Section (SSM-ES) is a hollow cylinder 61.25 inches long and 168 inches in outer diameter. Inner diameter is 120 inches, to accommodate the OTA. The basic structure is aluminum with four annular rings (two outer and two inner rings). The rings and connecting structural members are either bolted or riveted together.

The SSM-ES is the primary support structure for the HST. The FS is bolted to the front annular ring, and the AS is bolted to the rear annular ring. The HST is supported in the Orbiter cargo bay by three trunnions and a keel fitting. The two aft main trunnions and the keel fitting are part of the SSM-ES.

### 2.3.3.2 Forward Shell (FS)

The FS is a 121.2-inch diameter and 156.1 in. long structure that surrounds the OTA but is not attached to it. A series of external forged aluminum alloy rings provide stiffness to the integrally stiffened sheet aluminum shell skin, and attachment points for accessory hardware mounting. Accessory hardware includes the following:

- Solar array wing supports (2)
- Solar array aft latch supports (2)
- Forward trunnion
- Magnetic torquer supports (4)
- High Gain Antenna (HGA) supports (2)
- EVA handrails
- Foot restraint support sockets (8)

The FS is the primary structural support for the forward trunnion used for HST ground handling and for HST mounting in the Orbiter cargo bay.

The conservative design of the structure and fittings (Factor of Safety of 1.25 yield, 2.0 ultimate) and a proof test of the trunnions (1.2 times the design limit loads) provides assurance that trunnion failure is not a likely failure mode.

### 2.3.3.3 Light Shield

The light shield is a cylindrical structure 120 inches in diameter and 157.5 inches long. The complete light shield assembly is attached to the ST Forward Shell. The LS has integrally stiffened, machined aluminum/magnesium skin with longitudinal ribs, and internal annular rings with optical baffles attached.

The Light Shield provides:

- Stray light shielding for the OTA protective envelope
- Structural mounting for the
  - Aperture door
  - Forward LGA
  - LGA Waveguide
  - Forward scuff plates.

The Light Shield includes:

- Latches for both HGAs and AD
- Two forward latches for the solar arrays
- Two magnetometers
- Two sun sensors
- EVA handrails
- Three foot restraint support sockets.

### **2.3.3.4 Aft Shroud**

The Aft Shroud is a cylindrical structure with an inside diameter of 168.0 inches at the inside of the outer skin and a length of 138.0 inches. The assembly is closed at the aft end with a flat honeycomb bulkhead (attached through ring segments), and the front end of the assembly is attached to the SSM Equipment Section. The structure provides protection for and access to the SIs, FHSTs, WF/PC, RSUs, and FGSs. Access doors are provided for EVA astronauts for axial SI, WF/PC, and FGS changeout, and access to FHSTs and rate sensing units.

The Aft Shroud provides structural support for attaching the aft LGA and waveguide, EVA handrails, foot restraint sockets, three attach pins for the Flight Support System, and electrical umbilical disconnect mounts for deployment and orbital maintenance missions.

Two pairs of double access doors are provided for axial SI access, one centered on the  $+V_2$  axis and the other centered on the  $-V_2$  axis. A double access door is provided for FHST and RSU access centered on the  $-V_3$  axis.

## **2.3.4 Mechanisms**

### **2.3.4.1 Mechanism Control Unit (MCU)**

The MCU contains internally redundant electronics to control the deploy/retract actuators of the following mechanisms:

- Aperture door latch
- Aperture door drive hinge - open/close
- HGA latches
- HGA drive hinge
- Solar array latches.

The commands to the MCU are provided by the Data Management System (DMS). In addition to controlling routine deploy/retract functions, the MCU will initiate Aperture Door (AD) closure in response to bright object detector sensors and safe mode system signals. The MCU is installed in the SSM Equipment Section Bay 7.

### **2.3.4.2 Aperture Door Assembly**

The function of the Aperture Door (AD) is to preclude direct sunlight from entering the viewing aperture and to control stray reflected light. It also provides environmental contamination protection for the OTA during ground handling operations, ascent, orbit, and re-entry.

The Aperture Door assembly consists of the structural assembly, two hinges

(active and slave), a latching mechanism, and two electrically operated rotary drive actuators (one for the active hinge and one for the latch).

### **2.3.4.3 High Gain Antennas (HGA)**

Mechanisms for two HGA systems are provided. Each antenna subsystem consists of a 51-inch-diameter parabolic dish and feed, a two-axis gimbal drive, a mast, the deploy/retract/jettison system, and latches. The HGAs are stowed against the SSM (FS and LS) structure (one on the +V<sub>3</sub> and the other on the -V<sub>3</sub> side of the HST) while in the Orbiter cargo bay and are deployed or retracted upon command by a reversible motor-driven hinge mechanism.

The HGA hinges are mounted on the aft end of the Forward Shell structure; the stowage latching mechanism is mounted on the aft end of the Light Shield structure, with the mast approximately parallel to the V axis. The preload value for the HGA latches are 865 lb., +120, -0.

### **2.3.4.4 Latch Mechanisms**

The latch mechanisms are designed to secure the Solar Array wings, the HGAs, and the Aperture Door until each is to be deployed and then re-secure them at the time of HST retrieval. They all are similar in design and construction and have been developed by LMSC specifically for the HST program. The latch operates in three configurations: open with the appendage free to deploy or to return to the stowed position; closed and ready to preload; and closed-and-preloaded position. When in the preloaded position, the latch cannot release the load until the stepper motor operates the crankshaft spur gear about 160 degrees to the open position. The latch mechanisms are driven by the bi-directional rotary drive actuators. A protective housing is provided for the latching mechanism. All latches can be manually disengaged or re-engaged through EVA.

### **2.3.4.5 Bi-directional Rotary Drive Actuator**

Securing latches and deployment mechanisms are normally operated by compact bi-directional rotary drive actuators. This brushless motor is a three-phase, six-state wye-connected 1.5-deg permanent magnet stepper containing two physically and electrically isolated redundant windings. Each of the three-phase winding configurations is coded into six discrete operating states. Reversing the code sequence reverses the direction of motor rotation.

### **2.3.5 Pointing Control Subsystem (PCS)**

The PCS provides the HST with the capability of pointing at designated targets with sufficient accuracy and for the necessary period of time to achieve mission objectives.

The primary PCS functions provide attitude reference, attitude control and stabilization, and vehicle maneuvering during HST orbit operations. These functions have been implemented by using PCS sensors, actuators and associated electronics. Functional control is provided by an on-board computer in the Data Management System (DMS), and other support from vehicle subsystems. A limited amount of ground support consistent with Tracking and Data Relay Satellite (TDRS) coverage will be required for data updates and commands. In the event of two major PCS failures, a backup system provides vehicle control and stabilization for HST retrieval by the Orbiter.

The secondary functions of the PCS provides: momentum desaturation, equipment calibration, health status determination, failure detection, isolation, and safemode attitude control.

The PCS operates in a digital mode, uses software modules resident in the flight computer (DF-224), and hardware items physically located throughout the HST.

There are five different types of sensors that record HST attitude and rate measurements. These sensors are: Fine Guidance Sensor (FGS), Fixed Head Star Tracker (FHST), Coarse Sun Sensor (CSS), Magnetic Sensing System (MSS), and the Rate Gyro Assembly (RGA).

The DMS DF-224 computer calculates the control law, attitude updates, momentum management law and the command generators. To limit structural mode acceleration, the command generators shape the acceleration and incremental angle commands to the control systems in an accelerate, coast and decelerate pattern (DF-224 and Software).

Finally, actuators turn the control signal into torques that move the vehicle. There are two kinds of actuators: the Reaction Wheel Assemblies (RWA), and the Magnetic Torquers (MTs). Redundant hardware elements are provided to allow a timely resumption of science operations following a detected anomaly in system behavior.

The HST PCS is designed to meet the fine pointing performance of 0.007 arc sec stability, to maneuver the telescope 90 deg in 20 min. or less, and to provide the capability for deployment from, and retrieval by, the Orbiter. The PCS provides the capability for autonomous maneuvering, acquisition, and fine pointing based on time-tagged stored program commands as well as the ability for realtime interactive commands from the STOCC. Redundancy is provided in the PCS to the extent that one failure permits the mission to be continued, and two failures will not preclude recovery by the Orbiter.

The PCS is made up of the following components:

- Reaction Wheel Assembly (RWA) (4 provided, 3 required)
- Coarse Sun Sensor (CSS) (5)
- Rate Gyro Assembly (RGA) (6 gyro channels provided, 3 required)
- Fine Guidance Sensor (FGS)
- Fixed Head Star Tracker (FHST) (3 provided, 2 required)
- FHST Light Shade (3)
- Magnetic Torquers (4 provided, 3 required)
- Pointing Safe Mode Electronic Assembly (PSEA) (1, Internally Redundant)
- Magnetometer Sensor System (2 provided, 1 required)
- Retrieval Mode Gyro Assembly (RMGA) (1)

### **2.3.5.1 Reaction Wheel Assembly (RWA)**

Four RWAs are provided to generate control torques. The system can operate with three RWAs, should one fail. The input axes of both the rate gyros and the torque-producing axes of the RWAs are skewed relative to the HST LOS coordinates to provide system redundancy. Each reaction wheel has a 0.82 Newton-meter torque capability, +5,500 rpm maximum speed with 34 Vdc power and 0.84 Kg-m rotor inertia. The RWAs are installed in Bays 6 and 9 of the SSM equipment section. Each RWA spin axis is oriented at 45 deg to the  $V_2$  and  $V_3$  axes, and 20 deg above the  $V_2$ - $V_3$  plane.

### **2.3.5.2 Coarse Sun Sensor (CSS)**

Four analog sun sensor units are provided to detect incident solar radiation within their FOV and convert this information to sun presence signals and to sun direction signals. Each unit contains three monitor sensors that provide the presence signals and a dual redundant control sensor that



provides the direction signals. Zero sun angle, or null of the unit, occurs when the +z axis is aligned with the sun vector. The null accuracy is less than +1.5 deg for each axis.

### **2.3.5.3 Rate Gyro Assembly (RGA)**

Three of six onboard gyro channels are required to provide rate and attitude information used in controlling the HST. Four rate gyro channels are normally used. The gyros have a dual-rate range. The high-rate scale range is 0.5 deg/sec with a pulse weight of 0.015 arc sec. The low-rate scale is 20 arc sec/sec with a 0.00025 arc sec pulse weight.

### **2.3.5.4 Fine Guidance Sensor (FGS)**

The three FGS are located radially around the outside edge of the OTA. Each FGS is about five feet long and weighs 486 lb. The FGS generates attitude error signals during fine pointing about two orthogonal axes contained in a plane normal to the HST VI axis. The PCS then controls torques on the HST to null the pointing error and thus stabilize the target image.

### **2.3.5.5 Fixed Head Star Tracker (FHST)**

The FHST is an electro-optical device that uses an image dissector to search for and track stars in a large FOV. The FHST detects stars and provides star position and star magnitude data. The star tracker searches for and acquires +5.7  $m_v$  to +2  $m_v$  stars in an 8 by 8-deg FOV.

The unit tracks the acquired star with a small tracking pattern, following the star throughout the FOV. The tracker provides accurate two-axis position signals indicating the position of the star in the FOV. Upon command, the search mode is restarted, and the next star encountered in the FOV is acquired. The star tracker uses a 1-inch magnetically focused and deflected image dissector tube, a 70-mm f/1.2 optical lens, and associated signal processing electronics.

### **2.3.5.6 Fixed Head Star Tracker (FHST) Light Shade**

The primary function of the light shade is to reduce and control the degradation of FHST performance because of stray (unwanted) light sources not within the FOV of the star tracker. Stray light interferes with the ability of the star tracker to acquire (detect), track, and measure the LOS angles to selected reference stars. The unit is also a light-tight enclosure to protect the HST SIs and an integral part of the PCS for the FHST. The heat generated by the star tracker electronics is conductively coupled through the mounting interface plate to the light shade from where it is radiated to the aft shroud that surrounds it.

### **2.3.5.7 Magnetic Torquer Bars**

Four Magnetic Torquer Bars are used to dissipate and unload the energy buildup of the reaction wheels. The gravity gradient and magnetic torques are equal to the change in the reaction wheel momentum vector. The magnetic torquer coils are wound on a cylindrical iron core approximately 100 inches long by 3.0 inches in diameter and produce a magnetic moment of 2800 A-m (Ampere-meters) at rated current. The units have a capability of 100 percent duty cycle, require 16W at peak power, and weigh 97 LB each. They are mounted external to the forward shell with the axes oriented at 45 deg to the  $V_2$ - $V_3$  axes, and 35.26 deg above the  $V_2$ - $V_3$  plane. One redundant Magnetic Torquing Electronics Unit controls all four torquers.

### 2.3.5.8 Pointing Safe Mode Electronic Assembly (PSEA)

The PSEA monitors the keep-alive discrete pulses sent every 250 ms from the Data Management Subsystem (DMS). Upon failure to receive these pulses, the PSEA switches operation of the HST from DF-224 control to either the Sun Point Mode (SPM) or the Gravity-Gradient Mode (GGM).

In the SPM of the PSEA:

- SPM software is active to point a preselected axis to the sun.
- High Level Discrete (HLD) commands are issued to safe the HST.
- Solar Arrays are positioned properly.
- SPM software computes and provides torque commands to the RWAs to position and hold the HST to a predetermined orientation with the sun.
- Magnetic moment commands are issued to the magnetic torquers to desaturate the reaction wheel subsystem.

In the GGM of the PSEA:

- GGM software is active to point the VI axis to the local vertical.
- GGM is entered until failure to acquire or maintain the sun line when in the Sun Point Mode (SPM), or upon receipt of a sequence of commands while the PSEA computer is active.
- Solar Arrays are positioned to ensure adequate power.
- HLD commands are issued to safe the HST.
- Magnetic moment commands are issued to the magnetic torquers to rate-damp any vehicle motion.

### 2.3.5.9 Magnetic Sensing System

The Magnetic Sensing System consists of two 3-axis magnetometers (one redundant) to sense the earth's magnetic field. Outputs proportional to the field strength along each axis are used to calculate the required torquing currents for the magnetic torquer coils.

### 2.3.5.10 Retrieval Mode Gyro Assembly (RMGA)

The PCS contains an autonomous back-up system for attitude stabilization in the gravity-gradient and analog sun point modes. The system uses the PSEA and a dedicated RMGA to command control torque to the magnetic torquers. The RMGA can be activated either through the Safe Mode Electronics Assembly (SMEA) or by ground command by means of the command decoder. The RMGA is a nonredundant 3-axis rate sensor capable of providing analog output signals proportional to input rates about its three orthogonal axes. The RMGA is used also to provide vehicle rate signals for rate-damping during emergency retrieval of the HST or for analog sun point in the event of two rate gyro failures.

### 2.3.6 Data Management Subsystem (DMS)

The DMS provides for the acquisition, processing, storage, and dissemination of all data/commands between the communications subsystem and other subsystems on the HST. Major components of the DMS include a DF-224 computer, a Data Management Unit (DMU), four Data Interface Units (DIU) (three in the SSM and one in the OTA), three Engineering/Science Tape Recorders, and two Oven-Controlled Crystal Oscillators (OCXO).

The DMS provides the capability to accept, decode, and distribute forward link messages received via the HST communications subsystem; store time-tagged commands for subsequent distribution and execution; distribute and execute real time commands; gather, format and record/transmit HST engineering telemetry data; record/transmit science data, and perform PCS computations.

The DMS has the capability to provide realtime or stored scientific and engineering data to the communication subsystem for transmission to the TDRSS. In addition, the DMS provides elapsed time word and required clock frequencies for the SSM, SI C&DH module, and GTA (at a constant frequency, stable to within 10- 9 Hz in 24 hr.). The DMS also provides a master timing pulse to the SI C&DH module relative to a specific bit transition of a 32-bit DMS master clock to within 1 microsecond. The timing delay uncertainty for any path through the SSM is fixed and known to within 5 microsecond.

### **2.3.6.1 Digital Computer**

The DMS digital computer, a DF-224, consists of three identical central processing units, each having the capability to perform computations, format data, and transfer data; three identical input/output units; six power converters, and six identical memory units. The initial HST program is stored within the On-Board Computer (OBC) in a nonvolatile storage device. Software algorithms (required to perform planet tracking, velocity aberration corrections, parallax, and scan generation, and to initiate astrometry measurements) are stored within the computer. The capability to reload the computer upon ground command is also provided.

### **2.3.6.2 Data Management Unit (DMU)**

The DMU performs the central functions of the DMS. The DMU collects DMS functions into a single hardware package and provides interface between the DF-224 computer and all other subsystems and the HST modules.

The DMS is configured as a star or spoked-wheel data network. In this architecture, the DMU is the central controlling node (hub), with all the other units making up the outer nodes (spokes). Paths in the network pass through the DMU; i.e., there are no direct connections between the outer nodes except between the OCXO and WF/PC. The DIU is responsible for transferring data to the proper units. This is different from a data bus network, in which there is no closed loop and data placed on the bus are available to all units.

The external units that interface with the DMU are functionally redundant and most are cross-strapped (i.e., either one of a functional module pair can operate in combination with the other functional modules to form a complete operating DMU). Data are transferred serially between the DMU and the external units with the exception of the DMU/DF-224 computer interface, which has data transferred in parallel.

### **2.3.6.3 Data Interface Unit (DIU)**

The four DIUs on board the HST act as a remote extension of the DMU. The DIU interfaces with the SSM equipment, the SI C&DH module, the GTA and the Solar Arrays. The DIU decodes and issues High Level Descretes (HLD) commands, Low Level Descrete (LLD) commands (the GTA DIU only), and serial digital commands. It collects and processes bi-level, analog, and serial digital data. The DIU contains an 8-bit Analog-to-Digital (A/D) converter.

#### **2.3.6.4 Engineering/Science Tape Recorders (ESTR)**

Three tape recorders are provided to store engineering and science data. The input or record rates are 4 kbps (E/S data), 32 kbps (E/S data), or 1.024 Mbps (science data only). The output or reproduce rate is 1.024 Mbps. The input/output format is Non-return to Zero-L (NRZ-L) and the maximum bit error rate is 1 bit in  $10^6$  bits. The tape recorders convert the 4 kbps input data to a 32-kbps rate before recording. The three tape recorders are identical and are designed with a hermetically sealed enclosure.

#### **2.3.6.5 Oven-Controlled Crystal Oscillators (OCXO)**

The timing requirement for stability of  $10^{-9}$  in 24 hours shall be met with an OCXO. The SSM contains two units that provide the clock source for the DMS. Each unit contains a crystal oscillator with two 6.144-MHz sine wave outputs and has inner and outer temperature-controlled ovens. The constant 6.144-MHz sine wave output of the oscillator is supplied to the WF/PC and the DMU. The short-term, cycle-to-cycle stability of this sine wave output will be equal to or less than 0.007 percent. The oscillators conform to the detailed requirements of LMSC Specification 4171400 and are installed in bay 2 of the SSM Equipment Section.

**EXAMPLE**

### 3.0 SYSTEMS QUALIFICATION VERIFICATION

Systems qualification verification verifies that selected flight-type items meet the performance and design requirements under anticipated operational regimes and environments. Associated procedures shall be available for eliminating hazards during all mission phases. The following general rules apply to these verification tests/assessments:

- a. All environments of qualification tests shall be below design safety factor level and time exposure based on use cycle/type of flight item.
- b. Operational environments shall be simulated as practical during conduct of tests.
- c. All Qualification hardware shall be representative of flight hardware and software of known configuration. Any difference between the qualification and flight hardware or software configuration shall be documented and justified. To the extent feasible, dedicated test articles shall be minimized;
- d. Qualification verification may be conducted on subassemblies or assemblies.
- e. Life-cycle capability of moving mechanical items to end-of-life shall be demonstrated by test and/or assessment justified by analysis and documented as such. Consideration shall be given to all functional and environmental requirements.
- f. Any failures of hardware and software occurring during formal qualification testing shall be a basis for test stoppage. A complete analysis must be made of a failure and corrective action documented by a nonconformance report before qualification can be restarted. Retest shall be performed to establish the adequacy of the corrective action and restore the validity of previous testing. All unusual phenomena, difficulty, or questionable condition occurring in the conduct of the test shall be immediately reported to NASA.
- g. When the same hardware is scheduled for both qualification testing and flight purposes, the total life capability remaining after qualification (including retests) shall be assessed and justified as sufficient to complete checkout and flight mission requirements.
- h. Qualification tests generally should be sequential (e.g., one environment at a time) and nondestructive. Combined environments, plus functional test, may be performed when appropriate.
- i. A comprehensive acceptance functional test shall be conducted prior to the first environmental test to establish a performance baseline and at the end of the test series for final acceptance. Abbreviated functional tests, adequate to determine environmental effects, shall be performed after each environmental test. Life and thermal vacuum environmental tests shall include a functional test.
- j. Qualification verification shall be completed prior to start of AXAF-I system qualification/acceptance verification.
- k. Certification of Qualification (reference DR PA15) is required for each component, regardless of qualification method, test or assessment.

### 3.1 Modal Survey Test

A modal survey test of the AXAF-I system in the stowed condition is performed for verification of all modes up to 50 Hz. The STA is mounted on a support fixture simulating the upper stage interface. The flight optical bench with a HRMA simulator is supported off the STA. Mass simulations of the science instrument module (SIM), and AXAF-I equipment are installed. Multipoint random modal survey techniques are employed to determine the natural frequencies, mode shapes, and modal damping characteristics. Pretest analysis results are used to identify attachment locations and orientation for the shakers and accelerometers.

The modal survey results are used to update the analytical finite element model in the test configuration. The mass simulators are then replaced with the flight hardware analytic models in the finite element model representation. The Verification Craig-Bampton modal model is generated with the flight boundary conditions at the upper stage interface. The AXAF Observatory Craig-Bampton modal model is used by NASA to perform the Verification Coupled Loads Cycle analysis.

Separately, the deployed solar array and sunshade door analytical models will be verified by analysis and component test. The previously verified AXAF-I Observatory analytical model will then be modified to the on-orbit configuration and the deployed solar array and sunshade door models will be attached to obtain the verified AXAF-I Observatory On-orbit Model.

### 3.2 Thermal Vacuum Test

The Thermal Vacuum (TV) test verifies the flight-line hardware operates as designed and within the performance requirements when exposed to a simulated space environment. The TV simulated space environments will be at qualification levels. The TV testing demonstrates the ability of the thermal control system to maintain the system thermal excursions within defined thermal limits and to validate the thermal model and update, if required, to enhance the flight prediction capability. This also verifies that heaters have functioned for the temperature ranges experienced. The test also detects latent material and workmanship defects that respond to thermal vacuum environment stresses and simulated hot/cold orbit conditions.

The thermal vacuum test will be the first time at a systems level that the hardware will be in this environment. This will be a 28 day (24 hour day) test.

Thermal Vacuum testing will be performed with qualification modules installed except SA Wings, HGA (boom and two-axis gimbal) and AD. The AD opaque simulator will be installed. All thermal surfaces will be installed in flight configuration. The location of test instrumentation (removable or flyaway) that will be used to support the thermal vacuum test will be documented in the MOUs. The Instrumentation Plan will define the interface requirements that are necessary to control the compatibility between the instrumentation and monitoring equipment. Each Associate Contractor will be responsible for the installation, checkout, removal and/or termination, as appropriate, on his equipment. Correspondingly, each Associate Contractor will evaluate his own thermal data to assess his equipment performance, recognizing that collaboration and data sharing may be necessary to develop the complete understanding of the thermal characteristics. Temperature limits for the test instrumentation will be established pretest by each Associate Contractor and supplied to the systems engineering organization. Assurance that thermal limits are not exceeded during real-time test is by adjustment of the infrared (IR) lamps and/or by turning components/heater busses on or off. All data, real time and/or recorded, will be available and supplied to each Associate Contractor and NASA for review periodically during the test span. Data will be available on magnetic tape in a format readable by general scientific equipment such as IBM, PE3230, etc.

The thermocouples used by LMSC for thermal vacuum testing are copper/constantan. Lead wire for thermocouples will be cleaned to meet ST contamination requirements and can be either bonded or taped to the surface being monitored. Monitoring the ST environmental pressure is critical especially because of corona discharge effects. The thermal vacuum facility chamber has pressure instrumentation to verify the vacuum level external to the hardware.

A pressure transducer will be installed within the aft shroud to monitor internal pressure during TV/TB testing.

A contamination monitor will be installed within the aft shroud to monitor internally for contamination.

Prior to moving the qualification hardware to the TV chamber, an ORI will be conducted on the test facility. The ORI will include review of the chamber certification to the Contamination Control Plan and unique STE required for this test.

The qualification hardware, placed horizontally on the handling dolly, will be moved from the VATA to the clean room entry of the TV chamber. The test article will be raised from the handling dolly and supported from the monorail at the flight trunnions. The GSE/STE electrical and instrumentation cables will be connected gas purge to the ST's contacts. The TV chamber heat flux simulator lamps (a forward and an aft portion) are brought out from the chamber and placed around the hardware. Adjustments of the heat flux simulator are made and GSE thermal sensors circuits are verified at this time. The forward portion of the heat flux simulator and the hardware are moved into the chamber. After configuration is established in the TV chamber, an ambient checkout of the TV test configuration, consisting of a confidence test (ref. Section 9), remote monitoring of TLM, and GSE/STE checks will be conducted to assure that no anomalous conditions have developed since the last test and to verify the GSE/STE to hardware interface. Air conditioning ducts and test cables are connected and a confidence test performed, including verification of the GSE/STE to hardware interface, and remote monitoring of TLM. Air conditioning ducts are then removed, the aft portion of the heat flux simulator placed around the next to the forward portion. The hardware and the heat flux simulator are then positioned in the TV chamber. Purging will be maintained throughout the installation task with minimum interruption and terminated before the start of chamber pump-down. Interruptions are limited to one hour within a four hour period and no more than three hours of outages in a twenty-four hour period.

Witness samples and contamination deposition monitors will be installed in the chamber to obtain outgassing characteristics. The chamber door will be closed and power applied to the systems, which will then be functionally configured to the ascent power configuration. GN2 will be disconnected prior to pump-down. During chamber pump-down, continuous monitoring of selected TM points will be performed. Arrays of infrared (IR) lamps will surround the hardware and the TV chamber cold walls will be flooded with liquid nitrogen to simulate space sink. The thermal environment to the hardware will be controlled by adjusting voltages to various IR lamp zones. The initial voltage settings will be predetermined, based upon the thermal control surface and IR lamp characteristics at each location. The settings will be adjusted during the test according to test instrumentation readings and compared with the expected hot and cold case orbit predictions. At no time would any defined critical temperature be allowed to exceed a predetermined limit.

The main power busses will be on continuously throughout the TV test. Telemetry will be ON during all Functional testing at the hot and cold environments and during transition and soak periods. The GSE/STE temperature readouts will be monitored continuously. Continuous TLM may be interrupted if there is a priority situation requiring tape recorder dump and wideband recorder (WBR) playback. In addition, all telemetry data which is received via the ST test plugs

will be recorded as a permanent test record, to be used in reviewing events which occurred during soak periods. The total test span from the start of chamber evacuation to repressurization to ambient is anticipated to require 28 calendar days. The hot orbit conditions will simulate an orbit beta angle of 52.3 deg., low orbit altitude sun on the +V3, and the high absorbed fluxes considering the end-of-life optical properties. High duty cycle and maximum power dissipation rates will be maintained during hot orbit simulation. In this way, the various heater functions will be tested as well as the affect upon operating component temperatures. Circuits normally operated during maintenance mode shall be exercised. Cold condition will have cold orbit low power (component) dissipation configuration.

Functional testing at hot and cold orbit conditions will be supplemented by previously run simulated mission operations sequences. All primary and redundant systems operation will be scheduled to assure equal time at environmental conditions.

OTA stability is based on a 24-hour cold to hot or hot to cold slew requirement. Therefore, a representative slew test will be performed. The high to low tests are more severe than a slew test and too slow. The slew test temperature changes in the SSM environment would be accomplished over a shorter period of time going from cold to hot (about 20 minutes) and the response of the OTA will be observed over the following 24-hour period of time. Appropriate OTA equipment will be operational throughout this test.

When the chamber is pumped down and stabilized, the STVT will evaluate health and status based on test constraints to determine when the Confidence test will be performed. After the Confidence test is completed, the first cycle to be run will be optimum for achieving thermal stability and aft shroud/SI pressure stability as rapidly as possible. Heater checks will be performed during this initial high temperature stabilization period, to develop heater power profiles and determine the efficiency of that portion of the thermal design. A high-temperature Functional test will be conducted. After transition to low temperature, the systems will then be configured for low temperature and subjected to the lowest low-temperature environment during the TV verification cycle. The next phase is a safing test followed by a high and low temperature simulated mission operation followed by another low temperature functional test. The test will conclude with a final high-temperature Functional test. The test batteries will be programmed through various charge and discharge cycles during the test activities. Systems performance testing will consist of system tests simulating mission mode operations, functional tests, and SI detector dark count tests.

Upon completion of TV testing, the chamber and hardware will be prepared for repressurization.

The purge system will be reconnected within one hour after the chamber door is opened. An ambient Post-Thermal Vacuum Confidence test will then be performed to verify that the systems have not sustained any damage during repressurization.

Immediately after the Post-Thermal Vacuum Confidence test, the main chamber door will be opened, and the hardware will be placed on the handling dolly. Witness samples and contamination deposition monitors will be removed from the chamber for analysis and data will be made available.

### **3.3 Vibration Qualification Test**

#### **3.3.1 Random Vibration Qualification Tests**

Random vibration is performed at ambient test station pressure and temperature. Random Vibration testing verifies design operation in the vibration environment encountered during ground



transportation/handling, integration, checkout, prelaunch, launch, on-orbit, descent and post-mission activities.

Random vibration is composed of vibration exposures in three orthogonal axes in any convenient sequence. Mounting to the vibration test fixture is as closely approximate to FV mounting as practical. The component is powered on and in an operational state. All pertinent functional, performance, and safety critical parameters as defined in the particular specification are instrumented and monitored for the duration of vibration testing. A single axis vibration sequence is defined as follows:

- (1) Pre-Vibrational Functional Test
- (2) Power-On Vibration Test
- (3) Post-Vibration Functional Test.

### **3.3.1.1 Pre-Vibration Testing**

Pre-Vibration testing is performed prior to any axis vibration exposure or after a power cycle between vibration exposures. Pre-Vibration testing consists of executing power on functional/tests as identified in the particular specification. The results of pre-vibration functional testing provides a baseline of function, performance, and safety critical parameters, in determining the shift of these parameters across the vibration environment.

### **3.3.1.2 Power-On Vibration Test**

Vibration testing is performed with power on and in an operational state. The hardware is exposed to the vibration environment as defined in EV2-69 and the particular specification. During vibration exposure a systems power on functional/performance test is executed to test all power on redundant hardware, operational modes, and functions. Where insufficient time is available to complete power on functional testing at vibration qualification levels, extended testing at 6dB lower is conducted to complete functional testing.

### **3.3.1.3 Post-Vibration Functional Test**

Post-Vibration, power on functional testing is performed at the completion of vibration test and prior to power removal. The post-vibration function test is used as the pre-vibration power on functional test for subsequent axis vibration when power is not removed in the reorientation of the test article. After completion of post-vibration power on functional testing and power removal, a visual inspection of the component is performed to verify that no damage as a result of vibration has occurred.

### **3.3.2 Sinusoidal Vibration Test**

A sinusoidal vibration test is performed prior to random vibration testing to determine component natural frequencies.

### **3.3.3 Pressure Qualification Test**

Pressure testing verifies that design and fabrication provide sufficient margin to insure that structural failure or deformation does not occur over the maximum operating pressure and temperature. Pressure qualification is composed of proof pressure and burst pressure testing.

### 3.3.3.1 Proof Pressure Testing

Proof pressure testing is performed on FV components at the critical use temperature, as defined in the particular EQ specification. Proof pressure testing consists of:

- (a) Internal pressure is raised to proof levels as defined in the particular EQ specification operating pressure.
- (b) Proof pressure is maintained as defined in EV2-69 and then reduced to ambient.

At completion of proof pressure cycle the hardware is subjected to a complete visual and physical examination for deformation and to a functional test.

### 3.3.4 Acoustic Test

The FV acoustic test verifies the FV satisfies the CEI dynamic launch environment. Prior to conducting the acoustic vibration test an abbreviated function system test is performed to establish a FV status baseline. During the acoustic vibration test the FV is in a power off operational state with deployables in the stowed position. Keep-alive power is provided to the OBC.

The FV is subjected to an overall sound pressure level and duration as specified in EV 2-69. Test data provided from accelerometers mounted on the FV is collected and compared to expected values to verify response spectrum and correct input levels to FV hardware. At completion of the acoustic vibration test the FV is subjected to the following:

- (a) Complete physical inspection and examination to verify structural, electrical and mechanical integrity;
- (b) RCS and PM leak test to verify propulsion hardware integrity
- (c) An abbreviated functional system test to verify that no unacceptable shifts or degradation of FV functions has occurred as a result of acoustic exposure. The abbreviated EST includes exercising mechanical control functions to include deployment, latch, unlatch, and stow of FV mechanisms. Pre-acoustic deployment and mechanical control test of FV mechanisms are performed at ORU level testing.

### 3.3.5 ANALYSIS

Analyses are performed to verify the spacecraft and its subsystem level requirements. The analyses are discussed by subsystem in the following paragraphs. For those analyses which are later verified by test, the tests are described in Section 11, Subsystem Verification or 12, Spacecraft System Qualification/Acceptance Verification.

#### 3.3.5.1 Structures and Mechanisms Analyses

AXAF-I structures and mechanisms are analyzed for dynamic loads, stiffness, deflections, stress, thermal distortion, fracture mechanics and venting stresses as described below and shown in Figure 10.1.1-1 Spacecraft Structure/Mechanisms Analysis/Test Verification Process.

### **3.3.5.1.1 Dynamic Loads Stiffness and Deflection Analysis**

Coupled dynamic loads analyses of the combined AXAF-I/upper stage in the STS are performed to determine the dynamic loads in the spacecraft, telescope, and instruments. For each loads cycle, a dynamic finite element model of the AXAF-I Observatory is generated by coupling the Telescope System and SIM models to the spacecraft model. MSFC combines the AXAF-I model with the upper stage model and performs transient loads analyses for lift-off and landing flight events. Transportation and other flight events such as maximum  $q$ , maximum accelerations, on-orbit thrusting, and attitude changes are assessed using quasi-static load factors. Output from the dynamic analyses include STS Orbiter/AXAF-I/upper stage interface reactions, spacecraft/telescope interface reactions, SIM/telescope interface reactions, loads in instruments, internal loads and deflections in critical structural members, and deflections for assessment of Orbiter/AXAF-I clearances and accelerations of all significant items.

The dynamic analyses are performed at three intervals to ensure that updates due to changes in weight, equipment configuration, structural characteristics, or other modifications are included in the analyses.

### **3.3.5.1.2 Stress, Thermal Distortion, Fracture Mechanics and Venting Analyses**

Stress analysis of each structural member and joint is based on internal loads generated from quasi-static accelerations developed from the coupled-loads analyses. The elements are sized to preclude yielding, buckling, and/or failure conditions under the load spectrums specified by the STS ICD and including the AXAF-I factors of safety. Fracture mechanics analysis on metallic components is performed to meet the requirement of four complete lives. Protection against meteoroid and space debris is verified by analysis where required.

Temperature distributions from all significant coast, on-orbit, and landing conditions are assessed to determine thermally induced stresses and on-orbit distortions appropriate to operational pointing analysis. Thermally induced stresses are combined with stresses due to flight events in the structural element strength analysis. Output of the thermal distortion analysis is used to assess on-orbit distortion budgets.

The spacecraft components are designed to assure adequate venting to minimize differential pressure loads. Stresses due to these loads are included in the strength evaluation.

### **3.3.5.1.3 Appendage Deployment Analysis**

Sunshade door deployment analyses are performed to assess the dynamic motion of the door and determine latch-up and deployment loads. Results are used to establish the high and low temperature deployment test conditions and success criteria for the sunshade door mechanism verification tests.

### **3.3.5.1.4 Avoidance Angle Analysis**

The AXAF-I deployed configuration will be described by the master dimension layout (DWG #L301162). Sun blockage, plus the telescope and stray light shade field of view will be described by the field of view and observation layout (DWG #L301163).

The low gain antenna field of view, blockage and communication with the payload interrogator will also be described by the field of view and observation layout (DWG #L301163).

### **3.3.5.1.5 AXAF-I On-Orbit Control Weight Analysis**

Mass properties will analyze, control and verify spacecraft weight data. This includes: creating, publishing and updating a mass properties report (SE09); monitoring subcontract and government furnished equipment weight; and performing weight measurements on units as part of a weight measurement log.

### **3.3.5.1.6 Center of Gravity Analysis**

The AXAF-I facility weight data is analyzed with every update to the mass properties report (SE09). A section of this report verifies the AXAF-I CG compatibility with the shuttle upper stage and space transportation system (STS) capability.

### **3.3.5.2 Thermal Control Subsystem Analysis**

The spacecraft and AXAF-I level thermal control subsystem analyses verify thermal design and venting features as described in the following paragraphs:

#### **3.3.5.2.1 Thermal Control Design Analysis**

The primary analytical tools used for the spacecraft and facility level thermal analyses are the TRASYS II orbit environment and thermal radiation interchange analyzer computer program and the SINDA steady state and transient thermal analysis computer program.

Detailed geometric math models (TRASYS) and thermal math models (SINDA) of the spacecraft are used for accomplishing the spacecraft detailed thermal control design. The reduced math models (geometric and thermal) of the spacecraft are combined with reduced math models of the other modules or major assemblies (telescope system, aspect camera assembly, science instrument module and science instruments) comprising the facility to provide facility level math models (geometric and thermal) for evaluation of the integrated thermal design.

Thermal analyses are performed to establish the normal and worst case conditions for all on-orbit mission phases and equipment operating scenarios as well as for prelaunch, launch, shuttle abort contingency and transfer orbit.

The thermal models will be updated as appropriate following system level thermal vacuum testing of the AXAF-I facility. The models correlated to the test data permit final analytical verification of all environmental conditions and operating scenarios .

#### **3.3.5.2.2 Venting Analysis**

Verification of the design of the spacecraft and AXAF-I level venting provisions will be accomplished by a combination of analysis and test. Verification of the design for the high rate venting that occurs in the first few minutes of the launch will be accomplished by analysis at the box, module and facility level. Thermal vacuum testing at the facility level in conjunction with venting analyses will provide venting design verification for the low rate venting regime of the launch and subsequent on-orbit molecular regime venting design capability.

Venting design capability to accommodate the repressurization associated with air transport or a contingency shuttle abort will be verified by analysis as well as the venting design capability to

accommodate a potential shuttle emergency landing. For the latter case, the venting design shall not create a safety hazard to the astronauts or result in damage to the shuttle.

### **3.3.5.3 Electrical Power Subsystem (EPS)**

#### **3.3.5.3.1 EPS Analyses**

Subsystem analyses will verify the inclusion of the necessary equipment to generate, regulate, store and control primary power and to verify that protective devices of proper ratings (in accordance with TA-92-038 "Protection of Payload Electrical Power Circuits" dated 22 Feb. 1993) are included for all main bus power users. A model of the EPS components will be generated for use in EMI analyses of bus ripple, noise effects and bus transient studies. Energy balance analyses to verify solar array sizing adequacy will be made. Power distribution, bus voltage levels, power conditioning and ground isolation/return analyses will be made and verification by test at the spacecraft level will be included.

#### **3.3.5.3.2 Solar Array Analyses of Mechanical and Electrical Adequacy**

Electrical analyses, in conjunction with component level test data and subsystem requirements, will be made to verify the adequacy of the solar array sizing. This analysis will include the radiation effects as modified by the array materials themselves and will be included in a solar array power analysis computer program that has been developed and proven on several prior programs. Materials analyses will document the effects of short term exposure to atomic oxygen and will result in selection of appropriate coatings if required. Mechanical analyses supported by panel and wing level testing will verify that the array meets the spacecraft imposed stiffness/configuration requirements and along with test data will also verify the deployment and deployment redundancy requirements.

#### **3.3.5.3.3 Battery Analyses**

Battery analyses will be made to verify energy storage and recharge capability including the effects of loss of a battery. These analyses will incorporate data obtained during various cell level and battery level tests. Reconditioning capability will be verified at the spacecraft level since the controls (relays) are included in CCDM equipment.

### **3.3.5.4 Communication, Command and Data Management Verification Analyses**

The following analyses will be performed for the AXAF-I CCDM Subsystem. A brief description of each analysis is included.

#### **3.3.5.4.1 Communications Link Margins**

Communications analyses are defined by DR SE11. Communications link margin analyses will be performed to assure that the bit error rate and link margin meet AXAF-I requirements for all operating modes. The analyses will take into account all sources of transmit and receive losses and gains. These include transmit power, antenna gains, and passive losses in cabling and passive components. Other factors in the analyses include transmission path losses, data rates, error correction coding, modulation parameters, and antenna parameters. Ground station interface

parameters will also be included in the analyses. SE11 requires that these analyses include nominal and worst case conditions.

#### **3.3.5.4.2 Computer/Data Bus Usage Analyses**

These analyses will be performed in accordance with DM06 Volume 1 to show peak and average computer utilization of memory and throughput. In addition, analyses will be made to show peak and average CCDM data bus traffic.

#### **3.3.5.4.3 Data Management Analyses**

Data management analyses are required by SE11 to determine and quantify sources of bit errors for both engineering and science data. This DR also requires the definition of latencies/ staleness for data flows.

#### **3.3.5.4.4 False/Hazardous Command Probabilities**

An analysis will be made to determine the probability of false commands as a result of bit errors in the forward command link. The analysis will take into account the forward link bit error rate, error detection coding, and the command verification process. An analysis of all commands will be performed to verify that no command can change to a hazardous command due to a single bit error.

#### **3.3.5.4.5 Safety Analyses**

Communications safety analyses will be performed to show compliance with safety requirements for inadvertent RF radiation while in the STS cargo bay or while in the vicinity of the STS.

#### **3.3.5.4.6 Time Correlation Analysis**

Analyses will be performed to show compliance with the requirement for a 100 microsecond maximum time correlation error between the spacecraft and ground clocks. The analysis will account for path ranging accuracy's and known transmission delays in the spacecraft and ground systems. The delays and uncertainties associated with onboard data acquisition and onboard commands will be included in these analyses.

#### **3.3.5.5 EMC/EMI Analysis**

Electromagnetic compatibility will be verified by EMC engineering using TRW SEMCAP program. The objective of this analysis is to calculate the coupled interference levels of selected circuit interfaces from internal and external sources and to compare the total coupled interference level to the sensitivity of the particular interface circuit. The SEMCAP will be used to perform electromagnetic coupling analysis and to verify adequate electromagnetic interference margin at selected signal interfaces.

## 4.0 SYSTEMS ACCEPTANCE VERIFICATION

The activity described in this section reflects the requirements of CN250, Reduced Risk Program in addition to other coordinated changes. The Acceptance Verification begins with the Equipment Section installations and prepower tests and concludes with the stack and destack operations.

ST level of operations begin at the completion of the SSM stack/destack function milestones. The SSM will be disassembled at this time into its major sections and prepared for reassembly into the ST configuration.

Each major section will be properly protected to maintain cleanliness while awaiting the start of ST assembly. The ST assembly will begin with the availability of all the major elements of SSM and Associate Contractor hardware, including the NASA Compatibility Test Van (CTV) as scheduled. Reference Figure 3-1 for the required time phasing of the ST hardware as it relates to the reduced risk A&V program needs. Figure 3-2 defines the SSM/ST Assembly and Verification Flow. These two figures provide an overview of the SSM/ST A&V cycle from its initial assembly through final shipping preparations.

During and after assembly, the ST enters the verification cycle which involves a series of tests, inspections and demonstrations, both ambient and environmental, that will be designed to exercise the ST to verify requirements established in ST Verification Requirements and Specifications Document (VRSD), SAV1020. During all A&V activities involving the STAVF, GSE/STE and flight hardware will be maintained at a high level of cleanliness as defined in the PA-02 ST Contamination Control Plan. The experience gained from all contractor activity will be used to correct and enhance the test documentation in preparation or subsequent ST A&V activities. Also during this time span, all equipment and facilities to be utilized will be subjected to an Operational Readiness Inspection (ORI) as defined in the PA-01 Product Assurance Plan and as shown on Figure 3-1.

Two kinds of constraints have been identified in conjunction with the SSM/ST A&V. (1) Constraints that address the handling or configuring of the hardware for test (i.e., contamination control, appendage deployment, etc.) will be documented in the appropriate section of this plan and (2) operational constraints involved with the ST verification will be defined in the ST Verification Requirements and Specifications Document (VRSD), SAV1020.

Section 7.0 of this document introduces automated testing and provides descriptions of the major types of tests that will be performed during the ST verification cycle. Flight type batteries will be used for testing (ref. SAV1020, para. 3.3.1.4), Emergency Power Shutdown and Power Down Sequence, with preconditioning of subsystems, will be detailed in test procedures (ref. SAV1020, para. 3.3.2.5). Facilities and GSE/STE utilized during the ST A&V activities are described in sections 9.0 and 10.0. The figures in section 9.0 show GSE/STE utilization during each phase of assembly and verification. All activities described in section 3.0 are the responsibility of the SSM/ST Contractor, unless otherwise stated.

Environmental tests, modal, acoustic, TV/TB, conditioning, requirements, and instrumentation, are documented in SAV1020, SAV1025, SAV1026, and SAV1027, and in detail in the ST Environmental Test Instrumentation Plan, LMSC/D792999.

Purging requirements per SAV1020 state that limit outages of Nitrogen Purge is one hour within a four-hour span and no more than three one-hour outages within twenty-four hours.

## 4.1 Installation And Prepower Tasks

### OBJECTIVE

- a. Verify power interface between the SSM/ES and its interfaces by performing power bus continuity, isolation, and single point ground measurements.

Once the equipment section arrives in VATA, it will be installed in the test stand, trunnion test doors will be installed, and cable installations performed. Interface verification will consist of performing bus isolation, continuity, and grounding testing. Single point ground tests will be conducted. Once all interface testing has been completed, SSM/ES internal circuitry will be configured for the SSM/ES Functional Test.

## 4.2 SSM/ES Functional Test

### OBJECTIVES

- a. Assure satisfactory hardware and software functions of flight systems, including all interfaces, in accordance with the VRSD, AV-02.
- b. Exercise all commands and telemetry and functionally operate all redundant and backup equipment including redundant and cross-strapped paths where possible and practical.
- c. Perform negative mode testing to verify hardware/software functions perform as designed and invalid functions do not occur.
- d. Continue the reverification of component critical parameters and recording of component run-time (operating cycle) to insure no (1) degradation, (2) undesirable system interaction, and (3) workmanship failures.
- e. Verify SSM communications subsystem using the NASA CTV.
- f. Verify the SSM/ES to SIC&DH, OTA, SFS, SA, Shuttle Orbiter and SSE interface.
- g. Verify RF VSWR and Insertion Losses in all RF passive components, waveguide, and coax cabling.
- h. Verify shutdown sequences and safing procedures.

The SSM Equipment Section is to be functionally tested using SATS commanding and data retrieval in this configuration to every extent possible with appropriate test aids and simulators connected. VSWR and Insertion Loss measurements will be performed to determine RF system gains and losses. The charging and conditioning of the batteries will be conducted as required to make certain complete system power is available and within specification. Confidence tests of the DMS, I&C, SA, EPS, and Structures and Mechanisms (S&M) will be performed prior to the total SSM/ES Functional Test. A Single Point Ground (SPG) verification will be conducted also.

During this test span, the NASA CTV will be connected to GSE/STE for an interface test and SSM Communications Subsystem verifications.



### 4.3 Solar Array Receiving And Inspection

#### OBJECTIVES

- a. Verify that the SA and associated Ground Support Equipment (GSE) have not suffered physical damage or been exposed to excessive environments during shipping or handling.
- b. Verify that the specified cleanliness level has been maintained during shipping and handling.
- c. Verify that the GSE demonstrates continued functional integrity.
- d. Verify that the Acceptance Data Package (ADP) properly documents the hardware delivered.
- e. Verify functional operation of the SA Electronics Control Assembly (ECA) before installation into the SSM.

Prior to the start of the actual SA R&I, a team comprised of the SSM/ST Contractor, NASA, and ESA (as appropriate), will perform an Operations Readiness Inspection (ORI) against the depot and handling equipment. This ORI will assess the compliance of the facility and support equipment to meet contract requirement for safety (personnel and hardware), cleanliness, operating procedures and any other aspects relating to SA interface requirements (ref. PA-01, Product Assurance Plan).

Some Solar Array (SA) equipment R&I will be accomplished prior to SSM/ES testing. The remainder will be accomplished during ST testing, as shown in Figure 3-1. SA GSE is identified in Section 9.0. The SA R&I will be performed in the VATA.

SA equipment will be delivered to the SSM/ST Contractor in three phases. The first delivery will consist of the SA electronics, including Deployment Control Electronics (DCE), Solar Array Drive Electronics (SADE) and Diode Boxes and their associated GSE. The second delivery will include one Development Model Solar Array (D-Model SA) Wing and the associated GSE to handle the wing. The third delivery will include the two flight SA wings and its associated GSE.

The R&I performed on the SA will be the responsibility of the British Aerospace (BAe) Verification Team under direction of the ESA with SSM/ST Contractor Product Assurance (PA) personnel observing the activity. The BAe/ESA Verification Team will provide a detailed work schedule covering the R&I for inclusion into the ST A&V master work schedule.

Problems or anomalies detected during R&I will be reported to the ST Verification Team Leader (STVTL) (ref. Para. 4.1) on a timely basis to assure implementation of necessary contingency plans. Discrepancies identified during R&I will be recorded by the Associate Contractor QA personnel in their own documentation system; the SSM/ST Contractor Non-Conformance Reports (NCRs) (ref. Para. 6.1.5) will be used after start of installation of the SA on the SSM. Assistance in the categories of facility operation and support services will be furnished by the SSM/ST Contractor. In addition, the SSM/ST Contractor is responsible for unloading the SA and associated GSE from the transportation vehicle, and moving the equipment to the VATA. The external surfaces of all shipping containers moved into the VATA will be vacuum cleaned and wiped down. This service and materials will be provided by the SSM/ST Contractor.

Each flight wing will be removed from its transport container for visual inspection. This inspection activity will be performed either on laminate-covered work tables or on the Large Area Pulsed Solar Simulator (LAPSS) inspection rig. In either case, the length-compensation mechanisms will be disconnected from the ends of the bi-stems so that the blankets can be unwound from the

Secondary Deployment Mechanism (SDM) without deploying the bi-stems. In addition, a continuity check will be performed from the SSM interface connections. Electrical performance measurements, blanket and cell inspection, will be performed. Finally the SDM drums will be adjusted to launch-tension and the length compensation mechanisms will be reconnected.

After exterior and pin-to-pin visual inspection, the DCE and SADEs will be coupled to the checkout equipment and a complete functional test performed using the BAe Wing simulations in the checkout equipment as loads. Included also will be an electrical performance test using the ESA flasher. The diode boxes will be subjected to visual inspection and continuity checks.

The D-Model Wing blankets will not be unrolled during the visual inspection.

#### **4.4 Scientific Instrument Control And Data Handling R&I**

##### **OBJECTIVES**

- a. Verify that the flight SI C&DH and associated GSE have not suffered physical damage or been exposed to excessive environments during shipping or handling.
- b. Verify that the specified cleanliness level has been maintained during shipment and handling.
- c. Verify that the GSE and its associated software demonstrates continued functional integrity.
- d. Verify that the Acceptance Data package (ADP) properly documents the hardware and software delivered.
- e. Demonstrate that the functional integrity of the SI C&DH hardware remains unchanged since its pre-ship functional tests at GSFC.

Prior to the start of the actual SI C&DH R&I, a team comprised of the SSM/ST Contractor, NASA, and SI C&DH Associate will perform an Operations Readiness Inspection (ORI) against the depot and handling equipment. This ORI will assess the compliance of the facility and support equipment to meet contract requirements for safety (personnel and hardware), cleanliness, operating procedures and any other aspects relating to SI C&DH interface requirements (ref. PA-01, Product Assurance Plan).

The SI C&DH GSE are identified in Section 9. The SI C&DH R&I will be performed in Bldg. 156F.

Assistance in the categories of facility operation and support services will be furnished by the SSM/ST Contractor. In addition, the SSM/ST Contractor is responsible for unloading the SI C&DH and associated GSE from the transportation vehicle, and moving the equipment to the R&I area in the VATA. The external surfaces of all shipping containers moved into the VATA will be vacuum cleaned and wiped down. This service will be provided by the SSM/ST Contractor.

The R&I performed on the SI C&DH will be the responsibility of the SI C&DH Verification Team with the SSM/ST Contractor PA and AFQA observing the activity. The SI C&DH Contractor Verification Team will provide a detailed work schedule covering the R&I for inclusion into the ST A&V master work schedule.

Problems or anomalies detected during R&I will be reported to the STVTL on a timely basis to assure implementation of necessary contingency plans. Discrepancies identified during R&I will be

recorded in the Associate Contractor documentation system; the SSM/ST Contractor NCRs will be used after start of installation of the SI C&DH on the ST.

The SI C&DH Associate Contractor will also verify that the single string SI C&DH has not suffered physical damage or been exposed to any excessive environments during shipping or handling, the cleanliness has been maintained, and the ADP completely documents the equipment delivered.

During the SSM/ES Functional Test span, the VAPCS and flight SI C&DH are currently scheduled to be delivered to LMSC. After the VAPCS has been installed and checked out, the flight SI C&DH will be subjected to a R&I and installed in the SSM/ES.

## 4.5 Scientific Instruments (SI) R&I

### OBJECTIVES

- a. Verify that each SI and associated GSE have not suffered physical damage or been exposed to excessive environments during shipping or handling.
- b. Verify that the specified cleanliness level has been maintained during shipment and handling.
- c. Verify that the GSE and its associated software demonstrates continued functional integrity.
- d. Verify that the Acceptance Data Package (ADP) properly documents the hardware and software delivered.
- e. Demonstrate that the functional integrity of each SI remains unchanged since its pre-ship functional tests at GSFC.

The R&I performed on the SIs will be the responsibility of the SI Contractor's Verification Team with the SSM/ST Contractor and PA and AFQA observing the activity.

This section describes the activities that a SI Contractor can expect to experience during the delivery and R&I of his instrument and support equipment at STAVF. The SSM/ST Contractor has provided an area designated as the R&I depot in Bldg. 156F. This area will have GSE/STE power and environmental controls to meet the hardware temperature, relative humidity and cleanliness requirements. The SSM/ST Contractor will supply personnel to offload the SIs and move them into the R&I. Each Associate Contractor will provide the documentation, personnel, GSE/STE and expertise to perform the actual R&I. The R&I performed on the SIs will be the responsibility of the SI Contractors' verification team with the SSM/ST Contractor's PA and AFQA observing the activity. The SSM/ST Contractor PA organization will verify that the SI and GSE hardware and acceptance data package are in compliance with the shipping documentation.

Prior to the start of the actual R&I, a team comprised of the SSM/ST Contractor, SI Contractor, NASA, ESA (as appropriate), will perform an Operations Readiness Inspection (ORI) against the depot and handling equipment. This ORI will assess the compliance of the facility and support equipment to meet contract requirement for safety (personnel and hardware), cleanliness, operating procedures and any other aspects relating to SI interface requirements (ref. PA-01, Product Assurance Plan).

Each SI Contractor is required to satisfy his instruments purge requirements when the instrument is in the R&I depot, or in transit to/from the R&I depot and Bldg. 156F. The purge handoff to the

SSM/ST Contractor occurs at the time the SI is moved into the VATA; either in its shipping container, on a handling dolly, or installed in the ST.

Additionally, it remains the SSM/ST Contractor's responsibility to provide purge to the SI at test stations other than VATA as long as the SI remains installed in the ST.

The STAVF certified nitrogen gas purge supplies will be sampled for moisture content and hydrocarbon levels when the gas supply is replaced or replenished, or if the purge system has been contaminated. All GN2 purge supply systems will be recharged/filled with certified GN2 provided by the SSM/ST Contractor (ref. ST Contamination Control Plan, PA-02).

The external surfaces of all shipping containers moved into the R&I depot will be vacuum cleaned and wiped down. This service will be provided by the SSM/ST Contractor. Here the shipping containers will be opened and the equipment transferred to GSE handling dollies, using the SI handling equipment and facility overhead crane by LMSC personnel. The outer protective wrap will be inspected, cleaned and the equipment will then be moved into the R&I depot's 10K enclosure. Here the outer protective wrap will be removed. Then additional cleaning will be performed by Associate Contractor personnel.

The SI GSE is identified in Section 9 of this document.

The SI Contractor verification team will provide a detailed work schedule covering the R&I and for inclusion into the ST A&V work schedule.

Problems or anomalies detected during R&I will be reported to the ST Verification Team Leader (STVTL) in a timely manner to assure implementation of necessary contingency plans. These anomalies will be recorded by the Associate Contractor QA personnel in their own paper work system. Resolution and sell off to NASA and AFOA will be the SI Contractor's responsibility.

Upon completion of the R&I activity, the SI will be moved to the VATA in proximity of the VATS and laminar flow HEPA filter wall. The handoff of purge responsibility between the SSM/ST Contractor and the SI Contractor will occur immediately after the SI is transferred into the VATA. Purging will occur with previously sampled and tested GN2.

## **4.6 SSM/ES-SI Assembly And Prepower Tasks**

### **OBJECTIVE**

- a. Verify power interface between the SSM/ES and the SI hardware by performing power bus continuity, isolation, and single point ground measurements.

This activity includes those tasks necessary to verify that all interfaces are correct and ready for the EGSE/STE and SI's to be interconnected using VAPSCC cabling in preparation for the SSM/ES-SI Functional testing.

Test preparations and set ups will be described in the details of test procedures and enhanced by layout drawings.

All SSM/ES interfaces will be verified using LMSC furnished BOB's. All SI equipment interfaces will be verified using GSFC furnished BOB's.

All GSE/STE will be connected and configured for SSM/ES-SI Functional testing. The batteries will be charged and conditioned as necessary.

Purging and purging equipment will be furnished by each SI Associate Contractor as required. SSM/ST Contractors will provide purging during testing.

#### **4.7 Non-Powered Optical Telescope Assembly (OTA) And OTA-Equipment Section Receiving And Inspection**

##### **OBJECTIVES**

- a. Verify that the OTA including the OTA ES and associated GSE have not suffered physical damage or been exposed to excessive environments during shipping and handling.
- b. Verify that the specified cleanliness level has been maintained during shipment and handling.
- c. Verify that the GSE and its associated software demonstrates continued functional integrity.
- d. Verify that the Acceptance Data Package (ADP) properly documents the hardware and software delivered.
- e. Move OTA from shipping container with sling and crane to dolly and move into the VATA.
- f. Install the SSM RSU's and FHST's.
- g. Move OTA from dolly to ISS and remove OTA tooling ring.

The OTA and OTA-ES R&I is scheduled in two phases. The first phase will be prior to the start of preliminary ST assembly. The second phase will occur after the ST is partially assembled (ref. Para. 3.11). The R&I performed on the non-powered OTA and OTA ES will be the responsibility of the OTA verification team with the SSM/ST Contractor PA and AFQA in observance. The team will provide a detailed work schedule covering the R&I for inclusion into the integrated ST A&V master work schedule. The OTA GSE are identified in Section 9.

Prior to the start of OTA operations, OTA Product Assurance (PA) will participate in an Operational Readiness Inspection (ORI) of all facilities and equipment which will interface with the OTA and OTA-ES or be used during assembly operations to verify compliance with safety and handling requirements as specified in the ST Product Assurance Plan (DR PA-01). This inspection will include an assessment of facilities and handling equipment, cleanliness level, safety aspects of operational procedures and personnel capabilities. Since this inspection will be designated the preassembly ORI and be the first major ST utilization of the VATA facility, participation by all Associate Contractors and NASA will be scheduled.

The OTA and OTA-ES will be air-transported to the Moffett Field Naval Air Station. Related GSE will be packaged separately. The SSM/ST Contractor will transport the equipment from Moffett Field to the vicinity of the VATA. OTA personnel will visually inspect the OTA and OTA-ES shipping containers and the GSE. The SSM/ST Contractor PA will monitor all OTA R&I, as specified in the GFE Management Plan (DR LS-03).

The OTA recorded shipping environment data (e.g., shock, vibration, temperature and humidity conditions) will be analyzed by OTA personnel and evaluated for compliance with their transportation requirements and specifications. The OTA personnel will verify that the Acceptance Data Package is delivered and available.

Problems or anomalies detected during R&I will be reported to the STVTL on a timely basis to assure implementation of necessary contingency plans. Discrepancies identified during non-powered R&I will be recorded in the OTA documentation system by OTA personnel. The SSM/ST Contractor NCRs will be used to document anomalies after installation of the OTA into the SSM, except that during the OTA electrical R&I, anomalous conditions detected on the OTA side of the interface will be documented in the P-E system.

The external surfaces of all shipping containers will be vacuum cleaned and wiped down. This service will be provided by the SSM/ST Contractor in an area in Bldg. 156C adjacent to the SSM/ST Contractor, Bldg. 156F. The OTA and OTA-ES shipping containers will be moved into a limited environment control area outside the VATA large-equipment access doors. Here the shipping containers will be opened and the equipment transferred to GSE handling dollies, using the OTA handling fixture and facility overhead crane. The outer double-protective wrap will be inspected, cleaned and removed. The equipment will then be moved into the VATA and will remain at the end of the room nearest the large-equipment access door. After the VATA access doors are secured and the environment stabilized, the exposed OTA-Dolly external surfaces and the remaining protective wrap will be cleaned. The OTA and OTA-ES will then be moved to their designated areas in the VATA. Inner protective wraps of the OTA will be removed only after a 10K environment has been established so that OTA personnel can continue the OTA R&I. The OTA will remain in a horizontal attitude during this phase. (Note: An OTA protective cover will be installed as necessary to prevent the OTA from being exposed to a cleanliness level in excess of 10K in the event of VATA failure).

While the OTA is horizontal, for physical inspection, the OTA witness samples on the secondary mirror housing will be removed by OTA Contractor personnel and not replaced. Witness samples on the Focal Plane Structure (FPS) peripheral beam will be removed and replaced. All OTA witness samples will be analyzed by OTA personnel.

The OTA Contractor will then rotate the OTA in its dolly to the vertical position with +V1 axis up.

After the physical inspection has been completed, the three FHSTS without shades and the three RSUs will be installed by the OTA Contractor onto the SSM Equipment Shelf located on the OTA FPA. The electrical connectors for the FHSTS and RSUs will be mated to their respective cables by the OTA Contractor after each SI has been installed.

Bonding and isolation measurements will then be made by the SSM/ST Contractor and witnessed by the OTA Contractor.

As a prerequisite for the transfer of the OTA from the dolly to the Integration Support Stand (ISS), the OTA Contractor will have installed and aligned the ISS, and the SSM/ST Contractor will have aligned its guide rails in accordance with the ICD.

The first step of OTA transfer to the ISS includes the preparation of the OTA by the OTA Contractor by attaching the lift sling, attaching ISS guide rail followers, removing the trunnion and verifying that the OTA is ready for transfer. The SSM/ST Contractor will support the OTA Contractor by operating the facility hoisting and handling equipment as required.

The SSM/ST Contractor will transport the OTA in its tooling ring to the ISS and lower it into place on the ISS support fittings in accordance with OTA Contractor procedures. The OTA Contractor, after directing the above activity, will secure the OTA to the fittings, disconnect the tooling ring from the OTA, readjust the lifting slings, and direct the removal of the tooling ring from OTA by the SSM/ST Contractor in accordance with OTA Contractor procedures.

During this time period, the OTA electrical GSE (SCCER) will be shipped to the ST Integration Site.

The SCCER, in government furnished equipment, will be hooked up with the previously installed cabling in the ST facility. The other components, PBM, SOIB, and the auxiliary terminal, will be located and hooked up. The SCCER, installed in a government z furnished van, will be hooked up.

#### **4.8 SSM/ES-SI System Integration (SSM/ES-SI)**

##### **OBJECTIVES**

- a. Assure satisfactory hardware and software functions of flight systems, including all interfaces, in accordance with the VRSD, SAV1022.
- b. Exercise all commands and telemetry and functionally operate all redundant and backup equipment including redundant and cross-strapped path where possible and practical.
- c. Perform negative mode testing to verify hardware/ software functions perform as designed and invalid functions do not occur.
- d. Continue the reverification of component critical parameters and recording of component run-time (operating cycle) to insure no (1) degradation, (2) undesirable system interaction, and (3) workmanship.
- e. Verify SSM Communications Subsystem using the NASA CTV.
- f. Verify the SSM/ES to SI interface.
- g. Verify shutdown sequences and saving procedures.
- h. Monitor STOCC commanding compatibility.

Functional testing of the SSM/ES-SI interconnected system will be performed using the SATS commanding and data retrieval system. It will be verified that all SI's will function with the SSM/ES and its battery power according to the requirements in VRSDs SAV1020 and SAV1022.

#### **4.9 Weight and Center of Gravity**

##### **OBJECTIVES**

- a. Perform FS, LS, SSM/ES, and AS weight and CG measurements. Perform OTA weighing and CG measurements.
- b. Perform Light Leak Test.
- c. Perform Creak Tests.

The Forward Shroud (FS), Light Shield (LS), SSM/Equipment Section (SSM/ES), Aft Shroud (AS) and Optical Telescope Assembly (OTA) will be weighed and Center of Gravity (CG) measurements will be performed. A Light Leak Test and a Creak Test will be performed on the Aft Shroud.

## 4.10 ST Assembly

### OBJECTIVES

- a. Assemble the SSM ES to the OTA.
- b. Assemble the Forward Shell to the assembled ST elements.
- c. Assemble the OTA ES to the assembled ST elements.
- d. Install FGS/FGE #2 (Flight Unit No. 1).
- e. Demonstrate that the functional integrity of the OTA hardware remains unchanged since its preship functional tests at PE.
- f. Assemble the light shield to the assembled ST elements.
- g. Assemble the aft shroud to the assembled ST elements.
- h. Install the axial and radial SI's into the assembled ST elements.

Prior to the start of the actual R&I, a team comprised of the SSM/ST Contractor, OTA Contractor, SI Contractor, NASA, and ESA (as appropriate), will perform an Operations Readiness Inspection (ORI) against the depot and handling equipment. The ORI will assess the compliance of the facility and support equipment to meet contract requirements for safety (personnel and hardware), cleanliness, operating procedures and any other aspects relating to systems and equipment interface requirements (ref. PA-OI, Product Assurance Plan).

The ST assembly operations will be performed entirely within the class 10K cleanliness environment of the VATA. Prior to this, an ORI of the area/GSE will have been performed. Each major ST structural section, module or equipment which enters the VATA will be subjected to a thorough cleaning process. Shipping containers will be washed and dried, or vacuum cleaned and wiped down outside the VATA and moved behind a curtained-off area in front of the VATA door. This curtained-off area will be used to eliminate drafts of outside air from contaminating the VATA environment when the outer doors are open. In addition, the overhead crane inside the curtained area will be used to open the shipping containers and set the protective-wrapped equipment on their appropriate handling dollies or fixtures. The VATA doors will then be opened and the equipment moved inside. With the equipment at the entry end of the VATA, the protective wrappings will be cleaned and removed after the environment has stabilized. The environment air quality (contamination level) will be monitored and certified 10K or better before the final protective wraps are opened or removed. Details of operational space within VATA Will be addressed via MOU's and appropriate ICDs.

Preparations for ST assembly will have been completed prior to arrival of the OTA and OTA-ES. They are test documentation setup, e.g., Log Books, TP's, QA sections; planning area use; supplies and test support equipment procurement, facilities setup, etc. The SSM/ES and other SSM structures will be positioned in the VATA to support assembly operations in an area which will not hinder OTA activities.



## 4.11 ST Pre-Power Tasks

### OBJECTIVE

- a. Verify power interface between the SSM and the Associate Contractor hardware by performing power bus continuity, isolation, and single point ground measurements per SAV1023.

An ST Verification ORI will be conducted at this time on the computer complex of SATS and associated electrical GSE to include both SSM and ST requirements and any updating. The VAP Computer System (CS) configuration will be included in this ORI.

Shutdown sequences and safing procedures will be entered into SATS.

Several other tasks described below will also be completed in preparation for powering the ST.

GSE/STE cabling will be connected to the ST interface. ST Pre-Power checks will verify initial ST bus configuration, unregulated return isolation and bus resistance. The battery charge lines will also be checked for isolation from GSE and ST unregulated return, and all GSE returns connected to ST unregulated return will be verified. The air conditioning system ducts will be purged and connected to the OTA-ES and SSM/ES interfaces. Test batteries will then be recharged.

Connection of break-out boxes to associate contractor equipment will be performed by Associate Contractors with the SSM/ST Contractor observing, or the connection may be performed by the SSM/ST Contractor with procedure development and approval of the Associate Contractor.

## 4.12 ST Hardware/Software System Functional Verification

### OBJECTIVES

- a. Assure satisfactory hardware and software functions of flight systems, including all interfaces, in accordance with SAV1020 and SAV1021.
- b. Exercise all commands and telemetry and functionally operate all redundant and backup equipment including redundant and cross-strapped path where possible and practical.
- c. Perform negative mode testing to verify hardware/ software functions perform as designed and invalid functions do not occur.
- d. Continue the reverification of component critical parameters and recording of component run-time (operating cycle) to insure no (1) degradation, (2) undesirable system interaction, and (3) workmanship failures.
- e. Verify SSM communications subsystem using the NASA CTV.
- f. Verify operations of the ST system using mission mode criteria.
- g. Verify RF VSWR and insertion losses in all RF passive components, waveguide, and coax cabling.
- h. Verify shutdown sequences and safing procedures.

Prior to beginning the ST functional test, RF VSWR and insertion loss measurements will be performed on the ST waveguide and coax cable assemblies while they are connected into the system.

This test is to re-establish ground knowledge of the efficiency of the RF transmission elements of the I&C subsystem after ST assembly and to demonstrate the integrity of the interconnects within the ST. Subsequent RF continuity (open loop radiation) tests will verify the integrity of the antenna and RF equipment final connections. ST power will be applied using SATS automated power-on

and conditioning sequence to first configure the ST to minimum power configuration, and then powering each subsystem to its standard test configuration (ref. Section 7.2) observing any predetermined operational constraints. Each ST subsystem will remain powered in this configuration during all ST subsystem testing. with the OTA, SA, SI C~DH and SIs in the standard test configuration, tests of each of the SSM subsystems will be conducted. These confidence tests will be followed by detailed functional tests of the EPS, I&C, (manual) RF equipment, DMS, PCS, Safemode and SI C&DH systems.

After the SSM, OTA and SI C&DH subsystem functional tests are completed to SAV1020 and SAV1021 requirements, the functional interface between the SSM and the OTA and SIs will be verified. Each SI will then be tested with the other four SIs in various designated modes in the standard test configuration. The SI tests will be based on SI Contractor supplied test sequences and predicted telemetry responses.

After completion of the I/F Functional verification, a series of sequences designed to exercise the appendages (HGA, SA and AD) hinge and latch mechanisms will be performed. Each command and telemetry response (ref. DM-01 and DM-02), relative to the subsystem under test, will be verified by hardware performance. Since the SA flight wings will not be installed, the drive wing function interface resolvers will be tested by a GFE provided test set. This piece of ESTE will provide a simulated SA signal to the ST DMS for normal telemetry processing. This capability is derived from the design of the ESTE which responds to normal ST SA commands.

The ST Functional test will be designed to verify the functional performance parameters in SAV1020 and SAV1021. All primary and redundant commands will be executed and telemetry responses (ref. DM-02) verified. In some cases, only simulated responses or negative responses to commands may be verified due to hardware operational constraints or missing hardware. During SSM/ST verification, the thermal constraints of all electronic components will be observed by limit-checking both flight and/or test instrumentation, if applicable. In support of the development of test procedures to perform these test sequences, each Associate Contractor will have provided the SSM/ST Contractor with calibration data, constraints, logic model inputs, and telemetry response limits associated with their hardware. This test is also intended to verify the ST system using mission mode criteria.

A Light Leak test will be performed using the HSP. An exterior light source will be moved at various positions to cover 360 Degrees of the ST.

Any data anomalies will be reported using Data Discrepancies (DDs) or Non-Conformance Reports (NCRs).

Upon completion of the ST Hardware/Software Functional Verification and post-test data analysis, a meeting will be held by the STVTL and ST Systems Engineering to obtain the concurrence of all Associate Contractors and NASA to proceed with preparations for the FGS #3 installation and ST/FGS functional checkout. A similar meeting will be held after every A~V milestone test completion.

#### **4.13 Fine Guidance Sensor (FGS) #3 Installation And Functional Checkout**

##### **OBJECTIVE**

- a. Install and checkout FGS #3 and its FGE

FGS #3 will be installed into the ST by SSM Contractor personnel using SIFIG. OTA Contractor personnel will witness and upon completion of mechanical installation will hookup the FGS electrical cables. The OTA Contractor will then install the FGE #3 with assistance by SSM Contractor personnel and the SSM electronics installation tool. A functional confidence test will then be performed.

#### **4.14 ST Hardware/Software System Functional Verification #2**

##### **OBJECTIVE**

- a. Complete the objectives of the ST Function Test (see paragraph 3.13)

#### **4.15 ST Systems End-to-End Test**

##### **OBJECTIVES**

- a. Assure satisfactory hardware and software functions of flight systems, including all interfaces, in accordance with the VRSD SA W024 using flight mission sequences.
- b. Demonstrate ST/TDRSS with the TDRSS/STOCC compatibility using the NASA CTV.
- c. Conduct flight to ground interface compatibility verification which includes the STOCC via the TDRSS CTV (mission simulation sequences will be commanded by SATS and monitored by STOCC and then STOCC will command the ST with SATS monitoring. Selected data bases will be verified).
- d. Continue the reverification of component-critical parameters and recording of component run-time (operating cycle) to insure no (1) degradation, (2) undesirable system interaction, and (3) workmanship failures.
- e. Provide ST Verification Team (STVT) training/ familiarity with STOCC operations under simulated orbital verification conditions.

Prior to performing the STOCC compatibility test, selected members of the STVT will travel to the STOCC, to supplement ST Test Designers previously located there. STVT personnel required at the STOCC will include two Test Engineers and SSM, OTA, SI and SI C&DH Data Analysts. STVT will be responsible for all verification testing between the ST and the STOCC. Bit Error Rate (BER) tests will be performed for comparison of data between LMSC and STOCC.

The ST will be configured for this test phase with -the GSE/STE interfaces mated, including the appendage deployment simulation equipment. The ST will be powered using the standard power-on and conditioning sequence. Mission Simulation sequences will then be executed from the TCC in the VATA and the ST telemetry data will be monitored for correct responses.

This test will establish a baseline for STOCC I/F testing. The STVT at the STOCC will monitor the ST telemetry data via the CTV and TDRS/NASCOM as required during this operation. The STOCC will then take command of the ST, and the similar mission simulation sequences will be

repeated with the TCC monitoring the ST data. During execution of this phase, STVT Test Data Analysts will evaluate system performance to determine if the expected results were obtained. The ST will then be configured for ascent mode with power supplies through the Orbiter umbilical and extender cables from the deployment support equipment simulating the ascent mode configuration in the Orbiter cargo bay. Following ascent mode verification, the ST/SSE umbilical will be disconnected and the Simulated Mission Operations sequences will be executed by the STOCC to verify the capability of the ST to operate in an orbital configuration. Upon completion of this sequence, the ST will be powered off, the umbilical reconnected and data analysis completed. STOCC and SATS TLM data will be compared for uniformity and deficiencies. Installation of acoustic test instrumentation will be continued on a basis so as not to interfere with testing.

## 4.16 ST Modal Survey

### OBJECTIVES

- a. Provide information pertaining to the modal characteristics which is the basis for the system dynamic analyses. The modal survey provides the means for experimental determination of various modal parameters (i.e., resonant frequencies, damping behavior, and limited data on mode shapes per VRSD SAV1025.
- b. Provide information to support jitter evaluation, where feasible.

LMSC will supply, upon request, removable (non-flyaway) acceleration transducers to the ST Associate Contractors for support of the ST modal survey. However, each Associate Contractor will be responsible for the installation of the instrumentation on his equipment. The SSM/ST Contractor will provide assistance as needed. The transducers are sealed piezoelectric units, which will be bonded or mechanically attached to structural hardpoints. If the LMSC supplied instrumentation is not adequate or it must be "flyaway" because of access problems, the Associate Contractor will supply compatible instrumentation. Since much of the SSM Multi-Layer Insulation (MLI) thermal material will not yet be installed, problems associated with gaining access to the instruments will be minimized. The OTA will have its MLI already installed; therefore, most of the OTA instrumentation will be fly-away.

Upon completion of instrumentation installation, connection of the instrumentation cabling to the Modal Lab recorders and verification of the instrumentation channels, the ST and Modal Lab support equipment will be configured for the Modal Survey.

The ST will be configured to simulate, as closely as possible, the on-orbit physical configuration for the modal survey. ST assembly will be complete except for the SA wings, HGA boom and axis gimbals and dishes, and aperture door. Opaque protective covering will be installed over the end of the light shield to prevent contamination or damage to the OTA. Thermal control surfaces will not be in flight configuration and the SSM main power busses will not be powered. Nitrogen purge to the SIs will be maintained.

Prior to commencement of this test, an ORI will be conducted of the area and equipment involved in this test.

During the modal survey, the ST will be suspended vertically by three cables attached to Equipment Section Vertical Hoist Fittings at ST station 299. The cables will be attached to air suspension cylinders on a wye-shaped spreader bar assembly supported by the overhead crane. The ST will be excited with suspended shakers which will be frequency and phase correlated to define each mode with excitation in the 0 to 100 Hz range at a level of 0.01 to 0.1G.

Instrumentation for this test is detailed in the ST Environmental Test Instrumentation Plan, LMSC D792999.

It is planned to operate the RWA's, tape recorders and star selector servos in the FGS. During operation of these devices, acceleration is to be monitored at the primary mirror, secondary mirror, and optical benches of the FGS's in order to deduce over all line-of-sight jitter.

After the modal survey is completed, the ST will be repositioned on the support fixture, the related Modal Lab support equipment removed from the VATS, the transducer blocks removed from the structure, and residue of the bonding substance removed from ST surfaces.

## 4.17 ST EMC Verification

### OBJECTIVES

- a. Assure satisfactory hardware and software functions of flight systems, including all interfaces, in accordance with SAV1020 and SAV1026.
- b. Demonstrate electromagnetic compatibility of ST Systems by insuring that the system operates properly at critical test points when subject to internally generated sources.
- c. Continue the reverification of component-critical parameters and recording of component run-time (operating cycle) to insure no (1) degradation, (2) undesirable system interaction due to system environment, and (3) workmanship failures.
- d. Verify SSM communications subsystems using the NASA CTV Van.
- e. EMC verification will be performed while the ST system is in a mission mode.

The ST EMC test is to verify Electromagnetic Compatibility (reference the EMC Plan, SE-O9) at the ST level. EMI will be controlled at the component level and verified at the ST level in the EMC test. This test will basically consist of a series of functional test sequences, performed with altered ST configurations, which will demonstrate equipment EMC. A limited number of test points will be monitored including ST buses, single point ground and the power interface to one or more ST's as determined in the EMC test plan. EMC testing will also be performed while the ST is functioning in a mission mode.

EMC testing for worst case transfer from orbiter external power to ST internal power, shall be simulated with GSE power input to the SSE deployment umbilical.

EMC test equipment will be installed at various critical points within the spacecraft. These points will have been previously selected by analysis or by prior experience with the ST hardware. The EMC test equipment will be used to monitor the pre-determined critical interface circuits and power paths, and to verify safety margins for sensitivity and interference on these circuits. The two power sources which will be used during the EMC test are the ST test batteries and GSE/STE power supplies. During each phase of the EMC test, the power bus will be configured in a normal operating mode.

The ST will be powered up, 32K rate TLM mode will be selected for maximum sensitivity, and the special test sequence to establish EMC configuration will be run. When proper configuration, health and status have been verified, the EMC test sequence will be executed.

During the EMC test sequence, it is planned to:

- Measure conducted emissions, including transients on the unregulated 28-volt bus at two points:
  - In the Power Control Unit (PCU)
  - At one selected SI, RSU, FHST, Computer and DMU power connector.
- Measure structure skin currents:
  - At the ST SPG with current monitor
  - Between the DMU and one selected DIU
  - Between one selected DIU and PCU
  - Between the SI C&DH and PCU
- Radiated emissions of the ST will be measured during ST system EMC tests.
- Radiated susceptibility tests will be performed for S-band frequencies and KU band frequencies by separately irradiating the ST with an antenna scan vertically along the +V1 axis at 180 degree and 270 degree areas.
- Conduct susceptibility tests simulating shuttle power interface configured as on launch pad, with ST in orbiter.

The exact number of data points and circuits to be analyzed during the EMC test will be defined in SAV1020 and SAV1026, and the EMC Test Plan (SE-09).

After the EMC data are reviewed and approved, the EMC test equipment will be removed. The ST will be powered and a ST confidence test will be performed. The ST confidence test is a series of test segments verifying ST interfaces, but not all of the functional performance parameters. If an I/F connector has been disconnected to install test equipment during the EMC test, a Confidence test sequence will be performed as required to reverify that connector and/or component integrity.

#### **4.18 Mechanisms Installation And Checkout**

##### **OBJECTIVES**

- a. Install the SSM mechanisms.
- b. Perform fit/alignment verification.
- c. Verify mechanism unlatching, motor drives, and latching.

Flight mechanisms for AD, HGA, SA, and umbilical disconnect shall be installed, electrically connected, fit checked, and aligned. Harness routing shall be checked for non-interference of latching, unlatching actions. The mechanisms will be activated by commands from SATS. Angular indication and hinge switch positions will be verified by telemetry. Hinge preloads at deployed positions will be verified to specifications.

## 4.19 FGS Engineering Model (EM) Change Out

### OBJECTIVES

- a. Remove the FGS EM.
- b. Install and checkout FGS #4 and its FGE.

FGS #4 and its FGE will have arrived and be available for installation in the ST replacing the FGS EM thus making all FGS's flight hardware.

FGS #1 will be removed and FGS #4 will be installed into the ST by SSM Contractor personnel using SIFIG. OTA Contractor personnel will witness and, upon completion of mechanical installation, will hook up the FGS electrical cables. The OTA Contractor will then install the FGE #4 and remove the engineering model FGE, with assistance by SSM Contractor personnel and the SSM electronics installation tool. There will be an in-place confidence test performed using the ST and its associated GSE/STE.

## 4.20 ST Acoustic Verification

### OBJECTIVES

- a. Monitor selected SSM systems status during the acoustic exposure to verify that no intermittent circuit dropouts or relay/switch contact changes occur.
- b. Demonstrate the ability of the ST system to withstand the acoustic and vibration environments imposed during launch/ascent.
- c. Insure that the orbiter cargo bay acoustic excitation simulated by the acoustic chamber does not induce vibratory or acoustic responses beyond the qualification levels of any ST components and modules.
- d. Detect latent material and workmanship defects in ST components resulting from acoustic environment.
- e. Continue the requalification of component-critical parameters and recording of component run-time (operating cycle) to insure that the acoustic environment causes no (1) degradation, (2) unfavorable system interaction, and (3) workmanship failures.
- f. Verification to be per VRSD SAV1027.

Acoustic testing verifies ST response to simulated acoustic, random vibration and load environments occurring during launch. The expected Orbiter payload bay ascent acoustic environment will be simulated by the test chamber excitation in both frequency and intensity. Since ST verification is a joint qualification/acceptance program, maximum expected flight levels will be used to excite the external structure.

In preparation for the acoustic test, all safety precautions will be taken and an ORI will be conducted on the acoustic cell, ST handling dolly and related equipment not previously utilized. The following tasks will be accomplished to configure the ST as close as possible to the launch configuration. The HGA, SA wings and AD will be installed, fit checked, alignment interfaces checked, and latched in the stowed configuration with protective covers installed. The flight-type Aperture Door will be installed and a full AD deployment test will be performed. The flight HGAs will be installed and a micro deployment test will be performed on each HGA by opening the

latches and then commanding the HGA Hinge Motor through 500 steps. Telemetry will be monitored to verify proper latch operation and that the motors operate, but the HGA will be restrained so no actual movement of the HGAz will occur. Spherical bearing manual tests will be performed on the HGA and SA latches. A manual full deployment test/check will be performed on the HGA mast to verify the Service Loop and Hinge/Mast clearance envelope. Electrical latch open commands and PDM polarity checks will be performed. Verification of the SSM/SA interface continuity and isolation will be completed using the SA subsystem test plug. Electric simulators for the SA, AD and HGA gimbals will be removed and all thermal control surface material will be installed. After battery charging is completed, air conditioning ducts and GSE cabling will be disconnected. While the ST is in this flight configuration, SA protective covers will be removed and the ST envelope verification will be accomplished. Protective frames will then be installed and the ST protective cover will be installed. Utilizing the VATA hoist and MGSE slings, the ST will be moved from the VATS support fixture to the handling dolly. SI purge interruptions will not exceed 1 hour at any one time in a four-hour span nor more than three interruptions within a twenty-four hour period. The antennas will have mechanical constraints and the SA's will have bungee constraints in the event accidental deployment occurs.

Once the ST is secured in the transportation dolly, mechanical extensions will be added to the ST strongback structure to simulate the location of the umbilical retraction mechanism(s) mounts. The retraction mechanisms will then be attached to the strongback extensions and the electrical umbilicals connected to the AS half of the flight umbilicals. The remaining flight cabling and control panel will be added to the test setup and the retraction mechanisms functionally tested.

The support fixture will be lifted by the 20-ton overhead crane, using the sling assembly, and taken to the far end of the VATA high bay. There the support fixture will be mounted on previously cleaned portable air pads or heavy equipment transfer dollies and moved out of the VATA. The support fixture will then be positioned under the acoustic facility overhead crane and lifted off the transportation devices. It will then be positioned in the acoustic cell, leveled and secured to the floor.

After the support fixture is moved to the acoustic chamber, the ST will be transported to the acoustic chamber, hoisted and installed on the support fixture. Temporary access platforms will be used to disconnect the hoist fittings from the ST and connect the air conditioning and GSE cabling to the test plug and umbilical interfaces. SI purge will be connected so that gas flow can be maintained while the cell door is closed. After ST installation and GSE/STE hookup in the acoustic cell, a ST Pre-Acoustic Confidence Test (ref. Section 7) will be performed utilizing the SATS automated procedures and real-time data processing to verify that the ST survived transportation and setup in the acoustic cell, as well as providing a comparison baseline for ST Post-Acoustic Confidence test data.

The ST system level acoustic test will verify that SSM and hardware interfacing elements such as electrical connectors, latches, mechanical attachments, and ORU mounting provisions retain their integrity under acoustic excitation conditions. Subsequent physical inspection and functional tests will verify survival to the extent possible.

Microphones will be monitoring the environments to which the SSM and Associate Contractor modules are exposed, thereby preventing overexposure (and possible vehicle damage), and providing a proof-of-environment. Acoustic shaping of the test spectrum will be accomplished prior to arrival of the ST. Shaping will allow the cell operators to determine the appropriate one-third octave band filter attenuator settings which will be stored on paper tape.

The SSM will be powered and monitored by SATS (ref. Para. 9.1.1). The 32K telemetry mode will be used to monitor for failures and intermittents during acoustic exposure. No commands will be sent during the acoustic exposure. Review of the SSM/ST Contractor Satellite System Division



failure histories indicates that system-level failures occur during acoustic exposure and that some of these failures can be identified in real time. For this reason, LMSC plans to use the CTV to monitor the TLM through the RF link instead of using only the ST test connector to verify Spacecraft health and status. This powered configuration during acoustic exposure is perceptible in revealing intermittent anomalies and failures. It is recognized that some SSM/ST components will not be powered during acoustic environments due to operational or hardware constraints. The OTA, all SI's, and SA systems will not be on for this test. Such constraints will be defined by all Associate Contractors for their equipment and incorporated into Acoustic test procedures.

The Acoustic test will proceed as outlined below:

- Initial calibration acoustic exposure at full level of approximately 139 dB, for 75 seconds
- Process and analyze selected microphone and vibration data
- Make data available for contractor review
- Perform ST confidence test if required
- Re-shape acoustic chamber spectrum as required, to match expected flight profile
- Acoustic exposure at full level of approximately 145 dB, for 15 seconds
- Process and analyze limited microphone and vibration data
- Make data available for contractor review
- Acoustic exposure at full level of approximately 145 dB, for 45 seconds
- Process and analyze microphone and vibration data

After Acoustic test completion and preliminary data review for test objective achievement, a ST Post-Acoustic Confidence test will be performed to verify ST operation after being exposed to the acoustic environment. The SA system will not be tested at this time. The Acoustic test data will be analyzed by the SSM/ST Contractor and Associate Contractor personnel and compared with ST acoustic design and test criteria. A limited mechanical inspection will be performed. After satisfactory results are obtained, the ST and GSE/STE will be transported in the reverse process back to the VATA. The Support Fixture will be cleaned and reconfigured for subsequent ST verification. A full deployment of the AD will be performed to demonstrate that the AD latches will operate properly upon command, subsequent to the acoustic exposure.

The ST will be installed in VATS, where the ST protective covers and acoustic instrumentation will be removed. The SI purge will be maintained throughout the handling cycle and disconnected only for brief periods, not to exceed one hour as previously explained, as dictated by operations. An inspection of accessible ST structural surfaces will be performed to verify no damage or contamination during Acoustic testing. GSE/STE cabling will be reconnected to the ST and batteries will be recharged.

This inspection will permit the flight crew to inspect the ST in the pre-deployment configuration. The objectives to be accomplished include acquainting the astronaut flight crew with the ST deployment unscheduled maintenance procedures, observing a demonstration of the SSE technical features, and gaining an understanding of manual deployment of the HGA, SA and AD assemblies.

## 4.21 ST Post Acoustic Functional And Thermal Vacuum Preparations

### OBJECTIVES

- a. Assure satisfactory hardware and software functions of flight systems, including all interfaces, in accordance with the verification requirements specified in SAV1020 and SAV1027.
- b. Exercise all commands, logic, and telemetry and functionally operate all redundant and backup equipment, including redundant and cross-strapped paths, where possible and practical.
- c. Perform negative mode testing to verify hardware/ software functions perform as designed and invalid functions do not occur.
- d. Continue the reverification of component-critical parameters and recording of component run-time (operating cycle) to insure no (1) degradation after environmental exposure, (2) undesirable system interaction, and (3) workmanship failures.
- e. Prepare the ST for thermal vacuum verification.

### Post Acoustics Flight Solar Array Wing Verification

- a. Verify the functional operation of the flight SA wings after ST acoustics (removed from ST).
- b. Configure the flight SA wings to launch configuration.

After removal of the acoustic test instrumentation, the ST will be configured into a functional test mode.

During this time span, thermal vacuum/thermal balance test instrumentation installation will be started on a non-interference basis with the scheduled functional test activities.

The post acoustic task will be used to demonstrate that the HGA latches will unlatch and latch upon command, and that the HGA Hinge Motor will operate through the 500 step command, subsequent to acoustic exposure, with telemetry confirmation of each action and to verify that the ST survived acoustic exposure without degradation.

A ST systems functional test (ref. Section 7) will then be performed to verify ST systems performance after exposure to the acoustic environment and assure that data are comparable to previously executed systems functional test data.

After completion of the ST systems functional test, the WF/PC SI clock reversal test (jumper) connector shall be removed and replaced with the flight connector. A WF/PC Confidence (TBR) test shall be accomplished after the flight connector is installed prior to movement of the ST outside the VATA for the TV/TB environmental test.

- NOTE:
- 1) The WF/PC will remain in this configuration (flight connector installed) for the remaining test through launch.
  - 2) This is a short form functional test to verify WF/PC functioning after removal of the clock reversal connector and reconnection of the flight connectors. This connector

removal and functional test is required after post acoustic functional, but prior to removal from VATA for TV tests. It will add an estimated one shift to the ST Test Schedule.

A gimbal phasing test will be conducted on the HGAs (after removal of the RF antenna dish and feed) to verify gimbal assemblies have withstood the acoustic environment.

The HGA, exclusive of hinges and latches, will be removed from the ST and stored in a protected area until they are needed during ST preliminary shipping preparations. The SSM/SA interface will be verified by a continuity and isolation check. The SA wing will be demated from the ST and a functional test of the SA wings will be performed by BAe/ESA in the VATA, using the BAe/ESA GSE listed in Section 9, during the period that the ST is under test in the thermal vacuum (TV) chamber. During the demate process, the SA will be suspended by the VATA overhead crane while the stow latches are released and the SAD adapter is detached from the ST structure. The SA wings will then be lifted clear of the VATS, lowered and secured to the interface plate of the BAe integration trolley.

The SA wings will be subjected to a complete inspection and functional verification. With the interface frame mounted on the primary deployment rig, the Primary Deployment Mechanism (PDM) will be activated. The SA wings, on the interface frame, will then be attached to the integration trolley and positioned between the two halves of the secondary deployment rig (water tables) for the Secondary Deployment Mechanism (SDM) activation. For the PDM and SDM activation, the flight spare Deployment Control Electronics (DCE) will be used. The SA wing will be supported horizontally at the latch positions and with an air bearing rig to off-load the bearing in the SAD. The SAD will be functional, using the flight spare SADE, driving the stator around the rotor. The SADE will be used to drive the SAD stator around the rotor.

Finally, the SA wing on the interface frame will be mounted on the Large Area Pulsed Solar Simulator (LAPSS) rig so that continuity tests and electrical performance of the blankets can be verified. Each Solar Panel Assembly (SPA) will be exposed for flashing, as well as being visually inspected. Following the Functional Verification, the SA wing will be attached to the interface frame and positioned between the laminate-covered work tables, so that the blankets may be unrolled from the SDM drum and rewound at the correct launch tension.

At the conclusion of thermal vacuum instrumentation installation, a thorough inspection of the ST will be performed by a team consisting of LMSC, NASA and contractors. All thermal control surfaces (paint, flexible optical solar reflector [FOSR] and MLI) will be examined for proper installation, cleanliness, and proper thermocouple instrumentation. The AD will be removed and replaced by a vacuum-compatible cover or diaphragm. The ST protective cover will be prepared for installation, along with its environmental monitoring instrumentation (relative humidity, vibration/shock, and temperature). Thermal simulators will be installed for simulation of the HGA, SA and AD during thermal vacuum testing.

Upon completion of data analysis, the ST will then be transferred from the VATS to the Handling Dolly. At this point in the test flow, the Associate Contractors will no longer have direct access to the ST hardware or the Thermal Vacuum test area unless they possess security access gained in advance of thermal vacuum test activities. However, they will have complete access to the SATS TCC, from where the test will be conducted and monitored.

## 4.22 ST Thermal Vacuum/Thermal Balance Verification

### OBJECTIVES

- a. Assure satisfactory hardware and software functions of flight systems, including all hardware/software interfaces, in accordance with SAV1020 and SAV1028.
- b. Conduct flight to ground interface compatibility verification which includes an ST functional verification monitored by the GSFC STOCC via the NASA TDRSS and the NASA CTV.
- c. Exercise all commands, logic, and telemetry and functionally operate all redundant and backup equipment, including redundant and cross-strapped paths, where possible and practical.
- d. Continue the reverification of component-critical parameters and recording of component run-time (operating cycle) to insure that the TV environment causes no (1) degradation, (2) unfavorable system interaction, and (3) workmanship failures.
- e. Perform negative mode testing to verify hardware/ software functions perform as designed and invalid functions do not occur.
- f. Demonstrate the ability of the ST TCS to maintain the system thermal excursions within defined mission thermal limits.
- g. Validate the ST thermal model and update if required to enhance the flight prediction capability. Test data will be used to modify the ST thermal design if deficiencies are found.
- h. Detect latent material/workmanship defects that respond to thermal vacuum environmental stresses and simulated hot/cold orbit conditions.
- i. Verify SI operation in simulated space environment, including detector noise sensitivity.
- j. Verify that ST functions in mission mode.
- k. Verify that the ST meets thermal ICD limits.
- l. Verify all applicable heaters have functioned for the temperature ranges experienced.
- m. Verify SAFE mode

In order to accomplish qualification and acceptance verification, the thermal vacuum chamber activities will consist of a joint thermal vacuum and thermal balance test. The ST systems thermal vacuum test will be the first time at a systems level that the ST will be in this environment. This will be a 28 day (24 hour day) test.

ST Thermal Vacuum/Thermal Balance testing will be performed with all ST modules installed except SA Wings, HGA (boom and two-axis gimbal) and AD. The AD opaque simulator (MSTE 29) will be installed. All ST thermal surfaces will be installed in flight configuration.

The location of test instrumentation (removable or flyaway) that will be used to support the thermal vacuum test will be documented in the MOUs. The Instrumentation Plan will define the interface requirements that are necessary to control the compatibility between the instrumentation and monitoring equipment. Each Associate Contractor will be responsible for the installation,

checkout, removal and/or termination, as appropriate, on his equipment. Correspondingly, each Associate Contractor will evaluate his own thermal data to assess his equipment performance, recognizing that collaboration and data sharing may be necessary to develop the complete understanding of the ST thermal characteristics.

Temperature limits for the test instrumentation will be established pretest by each Associate Contractor and supplied to the ST systems engineering organization. SSM/ST Contractor will assure limits are not exceeded during real-time test by adjustment of the infrared (IR) lamps and/or by turning components/heater busses on or off. All data, real time and/or recorded, will be available and supplied to each Associate Contractor and NASA for review periodically during the test span. Data will be available on magnetic tape in a format readable by general scientific equipment such as IBM, PE3230, etc. The format details shall be mutually agreed on between the SSM/ST and Associate Contractors.

The thermocouples used by LMSC for thermal vacuum testing are copper/constantan. Lead wire for thermocouples will be cleaned to meet ST contamination requirements and can be either bonded or taped to the surface being monitored. Monitoring the ST environmental pressure is critical especially because of corona discharge effects. The ST thermal vacuum facility chamber has pressure instrumentation to verify the vacuum level external to the ST. The thermal vacuum chamber is described in Para. 9.1.4.

SI high voltage supplies/detectors will not be turned on until a pressure of 10(-6) Torr has been attained as measured by the pressure gage in the AS.

A pressure transducer will be installed within the aft shroud to monitor ST internal pressure during TV/TB testing. This monitor will be removed for flight.

A contamination monitor will be installed within the aft shroud to monitor ST internally for contamination. This monitor will not remain for flight. During transportation of the ST, shock/vibration instrumentation will be installed to provide a mechanical environmental record of transporting/handling periods.

Prior to moving the ST to the TV chamber, an ORI will be conducted on the test facility. The ORI will include review of the chamber certification to the ST Contamination Control Plan and unique STE required for this test.

The ST, placed horizontally on the handling dolly, will be moved from the VATA to the clean room entry of the TV chamber. The TV chamber overhead monorail will be extended and the ST placed under it with the -Y3 axis up. The ST will be raised from the handling dolly and supported from the monorail at the flight trunnions. The GSE/STE electrical and instrumentation cables will be connected to the ST, gas purge to the SI's continues. The TV chamber heat flux simulator lamps (a forward and an aft portion) are brought out from the chamber and placed around the ST. Adjustments of the heat flux simulator are made and GSE thermal sensors circuits are verified at this time. The forward portion of the heat flux simulator and the ST are moved into the chamber, with the aft part of the ST still outside. After configuration is established in the TV chamber, an ambient checkout of the TV test configuration, consisting of a confidence test (ref. Section 9), remote monitoring of TLM, and GSE/STE checks, will be conducted to assure than no anomalous conditions have developed since the last test and to verify the GSE/STE to ST interface. Air conditioning ducts and test cables are connected and a confidence test performed, including verification of the GSE/STE to ST interface, and remote monitoring of TLM. Air conditioning ducts are then removed, the aft portion of the heat flux simulator placed around the ST next to the forward portion. The ST and heat flux simulator are then positioned in the TV chamber. SI purging will be maintained throughout the installation task with minimum interruption and

terminated before the start of chamber pump-down. Interruptions are limited to one hour within a four hour period and no more than three hours of outages in a twenty-four hour period.

Witness samples and contamination deposition monitors will be installed in the chamber to obtain outgassing characteristics. The chamber door will be closed and power applied to the ST, which will then be functionally configured to the ascent power configuration. GN2 will be disconnected prior to pump-down. During chamber pump-down, continuous monitoring of selected TM points will be performed. Arrays of infrared (IR) lamps will surround the ST and the TV chamber cold walls will be flooded with liquid nitrogen to simulate space sink. The thermal environment to the ST will be controlled by adjusting voltages to various IR lamp zones. The initial voltage settings will be predetermined, based upon the ST thermal control surface and IR lamp characteristics at each location. The settings will be adjusted during the test according to ST test instrumentation readings and compared with the expected hot and cold case orbit predictions. At no time would any defined critical temperature be allowed to exceed a predetermined limit.

The SSM main power busses will be on continuously throughout the TV test. Associate Contractor hardware will be turned ON/OFF as specified by test requirements. Telemetry will be ON during all ST Functional testing at the hot and cold environments and during transition and soak periods. The GSE/STE temperature readouts will be monitored continuously. Continuous TLM may be interrupted if there is a priority situation requiring tape recorder dump and wideband recorder (WBR) playback. In addition, all telemetry data which is received via the ST test plugs will be recorded as a permanent test record, to be used in reviewing events which occurred during soak periods. The total test span from the start of chamber evacuation to repressurization to ambient is anticipated to require 28 calendar days. The hot orbit conditions will simulate an orbit beta angle of 52.3 deg., low orbit altitude sun on the +V3, and the high absorbed fluxes considering the end-of-life optical properties. High duty cycle and maximum power dissipation rates will be maintained during hot orbit simulation. In this way, the various heater functions will be tested as well as the affect upon operating component temperatures. Circuits normally operated during maintenance mode shall be exercised. Cold condition will have cold orbit low power (component) dissipation configuration.

Functional testing at hot and cold orbit conditions will be supplemented by previously run simulated mission operations sequences. All primary and redundant systems operation will be scheduled to assure equal time at environmental conditions. A typical thermal vacuum test profile is shown in Figure 3-3. An expansion of a typical transition is shown in Figure 3-4.

OTA stability is based on a 24-hour cold to hot or hot to cold slew requirement. Therefore, a representative slew test will be performed. The high to low tests are more severe than a slew test and too slow. The slew test temperature changes in the SSM environment would be accomplished over a shorter period of time going from cold to hot (about 20 minutes) and the response of the OTA will be observed over the following 24-hour period of time. Appropriate OTA equipment will be operational throughout this test.

When the chamber is pumped down and stabilized, the STVT will evaluate ST health and status based on SAV1020 and SAV1028 test constraints to determine when the ST Confidence test will be performed. After the Confidence test is completed, the first cycle to be run will be optimum for achieving thermal stability and aft shroud/SI pressure stability as rapidly as possible. Heater checks will be performed during this initial high temperature stabilization period, to develop heater power profiles and determine the efficiency of that portion of the thermal design. A high-temperature Functional test will be conducted. After transition to low temperature, the ST will then be configured for low temperature and subjected to the lowest low-temperature environment during the TV verification cycle. The next phase is a safing test followed by a high and low temperature simulated mission operation followed by another low temperature functional test. The test will conclude with a final high-temperature Functional test. The ST test batteries will be programmed

through various charge and discharge cycles during the test activities. SI Systems performance testing will consist of system tests simulating mission mode operations, functional tests, and SI detector dark count tests.

During temperature transitions (high-to-low and low-to-high temperature), the SATS will be monitoring telemetry data.

Upon completion of TV testing, the chamber and ST will be prepared for repressurization per ST Contamination Control Plan.

The SI purge system will be reconnected within one hour after the chamber door is opened. An ambient Post-Thermal Vacuum Confidence test will then be performed to verify that the ST has not sustained any damage during repressurization.

Immediately after the Post-Thermal Vacuum Confidence test, the main chamber door will be opened, the ST will be placed on the handling dolly, and the ST transported to the VATA for further cleanup and processing. Witness samples and contamination deposition monitors will be removed from the chamber for analysis and data will be made available to all Associate Contractors.

### **4.23 Compatibility Test**

The compatibility test will demonstrate satisfactory systems and SI performance under orbital conditions and will also verify satisfactory systems performance under maximum expected flight conditions. The test will be configured to demonstrate systems operation during a simulated launch and expected orbital operations. Orbital operations will be performed through simulated orbits. The test will be performed during thermal vacuum testing and as a part of mission simulation testing.

The compatibility test will be controlled from the Payload Control room during thermal vacuum testing and controlled from the Operations Control Center, utilizing the ground communication system to the extent possible, during mission simulation testing.

Systems will be in flight configuration except for solar array simulators installed during TV testing, test batteries installed, and GSE connected to solar array interfaces for battery charging. Data transmission and communications with the payload will be open loop through use of hat couplers. Systems, including SI's will be functionally operated through all configurations, primary and redundant, with cross-strapping. Telemetry formats, data rates, critical systems timing and tape recorder recording of engineering and science data and data playback will be verified. The flight software will be installed. Maximum command execution rates will be verified. Systems will be functionally operated with main bus voltage set at maximum operating voltage, at minimum operating voltage, and normal operating voltage. Maximum power loads are applied at all voltage levels. Trickle charging of batteries during night operations will be verified.

Systems, including SI's, will be verified to be without noise while operating in its maximum noise susceptible configuration and as each interacting system is configured to its maximum noise producing configurations. Selected points within the payload systems will be monitored. EMI voltage levels of selected components will be measured.

Pointing control and aspects determination functions will be demonstrated and verified. Target acquisitions, slews, scan modes, tracking, and fine lock will be verified. The science instruments will operate in low voltage, through operational modes, and provide simulated science data. Safing modes will be verified through ground command, with recovery from each safe mode.

## 4.24 ST Preliminary Shipping Preparations

### OBJECTIVES

- a. Remove non-flight hardware in preparation for shipping.
- b. Prepare ST for final functional tests and launch/OV dress rehearsals.

Once inside the VATA, the ST will be installed in the VATS and nonflight instrumentation will be removed. The leads of those monitor pickups which cannot be removed because of accessibility will be terminated, taped and stowed as close as possible to the pickup head. The thermal control surfaces will then be inspected, and optical properties (emissivity/reflectivity) measured and recorded as required. The test batteries installed in the ST will be removed, and final installation of flight batteries will be completed. The flight SADE's will be retested as required at box level.

## 4.25 ST Pre-Ship Functional Verification, Launch And Orbital Verification Dress Rehearsal

### OBJECTIVES

#### ST PRE-SHIP FUNCTIONAL VERIFICATION

- a. Assure satisfactory hardware and software functions of flight systems including all interfaces in accordance with SAV1020 and SAV1029.
- b. Exercise all commands, logic, and telemetry and functionally operate all redundant and backup equipment including redundant and cross-strapped paths where possible and practical.
- c. Perform negative mode testing to verify hardware/ software functions perform as designed and invalid functions do not occur.
- d. Perform the final flight software validation.
- e. Continue the reverification of component-critical parameters and record component run-time (operating cycle) to insure no (1) degradation, (2) undesirable system interaction, and (3) workmanship failure.

#### OV Dress Rehearsal

- f. Validate the OV procedures.
- g. Conduct flight to ground interface compatibility verification which includes the STOCC via the TDRSS CTV (OV sequences will be commanded by SATS and monitored by STOCC and then STOCC will command the ST with SATS monitoring).
- h. Perform representative OV mission sequences.

#### Launch Dress Rehearsal

- i. Validate the Launch site procedures.
- j. Conduct flight to ground interface compatibility verification which includes the STOCC via the TDRSS CTV (launch sequences will be commanded by SATS and monitored by STOCC and then STOCC will command the ST with SATS monitoring). Also included is a GSTDN/Deep Space Network (DSN) Interface check.



- k. Perform representative mission sequences.
- l. Conduct HGA and LGA RF end-to-end checks.

The ST Pre-ship Functional Verification is the last major power-on test to be performed on the ST before its shipment to the launch site. This functional will be a repeat of the original baseline performed earlier during the ST Functional with appendages installed. The primary objectives of this activity are to: (1) detect any latent workmanship defects in the ST after the Thermal Vacuum environmental exposure, and (2) demonstrate that there are no significant changes in the ST responses as compared to the original baseline data. The exercise is also the first opportunity to observe the performance of the recently installed flight batteries.

The CCC will be tested through their full operational range. The CCC test will be a repeat of special test sequences run during the first ambient EPS Functional test at the STAVF. Bus isolation and resistance measurements will be repeated, including GSE/ST battery charge-line and unregulated return isolation, power diodes will be checked and the flight batteries will be connected and charged. Conditioned air will be provided for cooling. The CTV will be returned to LMSC, connected to the facility, and set up to support STOCC testing.

After the completion of the Pre-ship Functional and associated data analysis, emphasis will be directed toward the Launch Site and OV dress rehearsals. Preparations for the Launch Dress Rehearsal will include the test setup of those portions of the SSE that will be used at KSC during ST prelaunch and launch activities. Facility air conditioning ducting will be connected to the ST interface. These rehearsals will be designed to ultimately demonstrate STOCC's ability to command and control the ST. The development of the required command sequences and telemetry modes to support these rehearsals will involve significant coordination effort between NASA, STOCC, Associate Contractor and STAVF personnel. When the sequences are finalized, STAVF personnel will incorporate them into the SATS ground test software. The end product will be a verification scheme that takes into account launch site time constraints and flight hardware limitation under ambient 1 g environments.

The rehearsals will be handled in two phases. During the first phase, the STAVF will execute the sequences against the ST and flight software to improve the integrity of and confidence in the rehearsal sequences. STOCC will monitor the ST responses to the rehearsal sequences in real time via some combination of the CTV, TDRS and/or NASCOM equipment. Additionally, the experience and data derived from phase 1 will be used as an operational baseline for phase 2 and launch site activities.

The second phase of the dress rehearsal will involve the STOCC as primary control center, commanding and monitoring the ST over the same GSE equipment described in phase 1. The STOCC will use the same sequences that STAVF used in phase 1, except for those adaptations necessary for compatibility to their computer and software systems. STAVF will monitor the ST responses with SATS during this second rehearsal phase.

An AS light leak test will be performed using an exterior light source and the HSP. The light will be moved to cover designated exterior areas.

Following the completion of the functional test and data analysis, a formal review of all NCRs and DDs will be convened by the STVTL, Systems Engineering, NASA and support organizations to determine ST status prior to altering the test configuration.

Once it has been assured that additional functional testing will not be required, the SA wings will be installed and electrically connected to the SSM interface. SA wing protective covers will be installed and SA wing continuity and isolation test of the interface will be performed.

A micro deployment test of the HGAs will be performed by restraining the HGAs and then unlatching the HGA latches, commanding the HGA Hinge Motors through the 500 step stow operation and closing the HGA latches. Telemetry will be monitored to verify this complete operation. A micro deployment test of the AD will be performed to verify the electrical interface with the MCU. Facility air conditioning ducting will be disconnected from the ST interface. Flight batteries will be discharged to the specified level for transportation and the GSE/STE electrical cabling will be disconnected from the ST interface.

## **4.26 ST Final Shipping Preparations**

### **OBJECTIVES**

- a. Perform the final inspection of ST hardware.
- b. Perform the ST Final Readiness Review.
- c. Perform the Final Shipping Preparations for transportation.
- d. Perform ST vertical weighting and C.G. measurement

A final inspection of the ST hardware and documentation will be scheduled after completion of the ST Pre-Ship Functional test and associated data analysis. In conjunction with the final inspection, Systems Engineering will convene a meeting of the STVT, NASA and support organizations to review the disposition of all DDs and NCRs. Systems Engineering will assure that all is ready for a Flight Readiness Review (FRR).

The FRR will include Log Book review by the SSM/ST Contractor, Associate Contractor, ESA and NASA personnel to assure that all items are closed. The data to be reviewed include:

- ST Acceptance Data Package
- Flight hardware/software configuration certification
- Software configuration status summary
- Transportation and handling documents
- Readiness assessment and certification of flight-worthiness endorsements and waivers

The final shipping preparations will begin after discrepancies and failure analyses are resolved, and the FRR is completed.

After receiving notification from the ST FRR chairman, the electrical GSE, SSE and those items of mechanical GSE which are no longer required at the STAVF will be inspected, cleaned and prepared for shipment to KSC. A government properties transfer document will be prepared on those items to be assigned to NASA for delivery to KSC.

Protective covers will then be installed around the ST to maintain the ST external Class 100K cleanliness level during transportation. The nitrogen gas system will be maintained to the ST distribution manifold for SI purge during transportation. The ST will be removed from the VATS and installed in its shipping container. Both the ST and supporting mechanical GSE will be moved to the transportation vehicle loading area for transportation to KSC. ST Integration Contractor and OTA Associate Contractor personnel will prepare to accompany the ST during shipment to KSC.

## 4.27 ANALYSIS

Analysis comprises a major portion of telescope verification. To assess on-orbit performance, analysis is the only method available. Analysis also provides the most cost effective means of verification for many requirements. Lastly, analysis is used heavily during the design phase prior to availability of actual hardware. Where available, analyses will be updated with actual test and inspection data. Unless otherwise specified, all analyses are documented through use of Kodak's "AXAF-I Technote System".

### 4.27.1 Structural Analysis

Telescope level structural analyses will be performed to show that the telescope is compatible with the applied loads and stresses, including launch loads and on-orbit environment. In addition, structural analyses will provide information for fracture control and safety evaluations.

#### 4.27.1.1 Dynamic Analysis

Telescope level dynamic analysis will be performed to determine the natural frequencies and mode shapes of the telescope, and to verify that the natural frequencies are greater than or equal to the value as specified in the Telescope specification (EK-5003-016). The analysis is completed using MSC NASTRAN and models generated through MSC MESH, MSC XL and using superelements. These include specific models of the three telescope assemblies which are described in subsequent sections. Dynamic analysis at the telescope level will consist primarily of combining the results of dynamic analyses of the HRMA, SSA and OBA, as well as incorporating modal survey test data when available.

The results of this dynamics analysis will be used to support assessment of on-orbit dynamic disturbance impacts on imaging performance (verifying that those impacts are less than or equal to the requirements as outlined in the telescope specification), as well as telescope stress analysis. Dynamic analysis will also verify the stability of interface mounts for the Science Instruments, Spacecraft, Aspect Camera, OTGs and all other interfacing equipment.

#### 4.27.1.2 Stress Analysis

Stress analysis of the telescope and its assemblies will be completed to determine the maximum stress levels, the loading condition driving that stress and that the appropriate factors of safety as defined in MSFC-HDBK-505 are met. Deflection results will verify the adequacy of the offloading concepts to be used during HRMA assembly/alignment and x-ray calibration. Analysis of ground handling, mounting, transportation and operation will also confirm that the stress imparted to the mirror elements will not, under any conditions, exceed 1,000 psia.

Initial loads used in the stress analysis are derived from the AXAF-I final briefing (and its supporting analysis) and are listed in the telescope specification. Worst case combinations of loads will be determined and will form the limiting cases for analysis. When more accurate load data in these two areas is available, these analyses will be assessed to determine the need for updates. Note that the transportation and handling loads are required to be no greater than 80% of the flight loads. This obviates the need to analyze these as a separate verification activity. Transportation and handling activities will be monitored to ensure that the actual loads do not exceed the 80% level. The stress analysis will also include worst case thermal effects for the operating temperature extremes.

### 4.27.1.3 Mass Properties Analysis

The assemblies of the telescope, and the complete telescope, will be analyzed during the development phase to verify and monitor conformance to the weight, center of gravity, and moment of inertia requirements as given in the telescope specification. Results of this analysis are given in the Mass Properties Report (DR SE09) which will be updated on a bimonthly basis to communicate the status of these parameters. This analysis will be updated with actual weights will be obtained during the manufacturing cycle where available.

### 4.27.1.4 Thermal Analysis

Thermal analysis of the telescope will be performed to support stress analysis. In addition, analysis will also be performed to determine the effects of thermal variations during on-orbit performance. A thermal model of the entire telescope, as well as a model of the HRMA, will be developed and exercised separately. In addition, thermal models of critical assembly and alignment operations, equipment and facilities will be performed.

Error budgets have been developed for the telescope assemblies (and facilities) and this analysis will be compared to those allocations. These analyses will be updated with actual data, including HRMA XRCF thermal balance testing, and, if possible, observatory level thermal vacuum test data, when available. The primary tools for this analysis are NEVADA, NASTRAN, SINDA, TRANSYS and FLUENT (air flow).

The thermal analysis will cover both operating and survival conditions as described in the Thermal Environment Analysis paragraph of this document. Distortions which are predicted as a result of this analysis will be incorporated into optical and alignment analyses. The final model will be provided to TRW.

### 4.27.1.5 Fracture Analysis

Fracture control assessment and analysis will be performed in accordance with Kodak's AXAF-I Fracture Control Plan (DR SE33). This analysis focuses on both components (which are assessed for containment, fail-safe and/or low mass and analyzed for safe-life or damage-tolerant) and assemblies, which are primarily focused on joint analysis. Tests and inspections that are conducted to further verify conformance to fracture control requirements are discussed in the subsequent sections. Where applicable, the fracture analysis will be updated with actual data.

## 4.27.2 Optical Analysis

Optical analysis is the ultimate method of verifying telescope performance. The outputs of other analyses, inspections, and tests are input to the optical analysis to assess on-orbit performance. The Kodak software package "CYGNUS" is the primary tool for optical analysis. In addition some work is done using standard optical analysis.

### 4.27.2.1 X-Ray Optical Analysis

Using CYGNUS, the encircled energy performance of the telescope is assessed. Initial performance budgeting was done using CYGNUS and the performance prediction will be updated as actual data becomes available. Inputs to this analysis will include actual mirror metrology data, alignment measurements, contamination data, coating data, distortions and displacements from NASTRAN and XRCF data. When needed, CYGNUS is aided by use of the HDOS program EEGRAZAX for determining RMS image diameter values.

#### **4.27.2.2 Standard Optical Analysis**

Standard optical analysis is used to evaluate the fiducial transfer system and during HRMA alignment and assembly. Telescope level and XRCF alignment may also be supported by standard optical analyses. Refer to the HRMA portion of this document for XRMA alignment and fiducial transfer component analysis. Standard optical analysis is performed using CODE-V, ASAP (stray light) or similar software packages.

#### **4.27.3 Environmental Analysis**

Environmental analysis will verify that the telescope and its assemblies can meet all of their requirements during exposure to operational environments and after exposure to survival environments as specified in DR SE29, "AXAF-I Environmental Requirements" and in the appropriate specifications. As part of this analysis the modification of the external environment for internal components and assemblies will be determined and allocated. Individual assemblies will then be compared to their expected environments. All analyses used to verify performance requirements will take into account the specific environment in which the component or subassembly is expected to operate or survive. The environments to be considered are thermal (including pressure and humidity), radiation, and contamination. Transportation/handling and storage are considered separately, but fall under the survival environments.

##### **4.27.3.1 Thermal Environment**

Thermal environmental analysis will consider the external operating and survival temperature ranges of the telescope and the internal effects. It will also account for any pressure and/or humidity effects from ground handling and launch, as well as internal radiation and conduction of heat. Temperature sensitivity of the telescope and its assemblies will be calculated and the designs optimized to take advantage of those sensitivities. Thermal analysis is further described under each subassembly heading and as part of the thermal control system analysis (Section 20.1.1.4).

##### **4.27.3.2 Radiation Environment**

The cosmic radiation environment will be defined by TRW for AXAF-I and must eventually be distributed to the telescope and its assemblies, primarily through viewfactor analysis. That analysis will be performed using "Space Radiation", a software package purchased from Severn Communications Corporation or other similar analysis package. The analysis of the external radiation environment will determine the appropriate viewfactors and attenuation's for internal portions of the telescope. This will be allocated and flowed down to the individual assemblies (HRMA, OBA, SSA) and analyzed accordingly.

##### **4.27.3.3 Contamination Environment**

An allocation has been made for particulate contamination at each stage of the program. Performance effects of contamination are confined to the HRMA and are discussed in the HRMA section. Facilities evaluation is discussed in the facilities section. Kodak will perform an analysis to determine the overall level of contamination expected and the resultant performance effect. This analysis will be supplemented by actual contamination data when available.

#### 4.27.3.4 Transportation and Handling

The transportation and handling environment has been defined such that it does not exceed the specified flight environment. In the case of transportation loads, the requirement is not to exceed 80% of the flight loads. Consequently, there is no analytical verification of the environment required, however the actual loads will be assessed against this requirement. Dry run transportation and handling activities with non-flight/prototype hardware are planned to verify transportation and handling loads.

#### 4.27.4 Electrical Analysis

The following features of the telescope electrical system will be analyzed to assess compliance with their respective requirements:

- power consumption required for thermal control under both operating and survival scenarios.
- radiation effects on electrical materials, components and operation.
- grounding analysis for both ESD and contamination control.
- magnetic fields and electromagnetic interference and compatibility (EMI/EMC) for the telescope system itself, or the telescope as part of the observatory and per the STS requirements.
- environmental effects (i.e., pressure, humidity, atomic oxygen, etc.) on the telescope electrical system and its components.

The assessment of power consumption will be in accordance with DR SE10 "Electrical Energy and Power Status Report". Radiation sensitivity, ESD sensitivity, etc. will be assessed primarily through careful selection of components and materials. Preliminary analyses will include assessment of ESD, EMI and EMC compatibility. This included verifying that the telescope is self-compatible and neither generates nor is susceptible to strong external magnetic fields.

#### 4.28 Inspection

In addition to incoming inspection for all parts and materials, in-process and final inspection will play an important role in establishing that many telescope level requirements has been implemented in the design and manufacturing process. Often inspections are conducted in conjunction with a test or as part of assembly operations documented by manufacturing instructions (MI's).

In process and telescope level inspections will include envelope verification, properties such as weight and resistance and relative locations of various components and subassemblies. Inspections will also be the primary means of verifying the various mechanical interface provisions required for telescope assembly and mounting of interfacing equipment as specified in the Spacecraft to Telescope ICD (IF1-29). Inspection will also be the primary method of verifying compliance with the design and construction requirements of the telescope Specification including installation of fasteners, bonded joints, wiring and cable harnesses, sealing and finishes, workmanship, connectors, cleanliness, etc. To support assessment of contamination, witness samples will be inspected. Each of the three telescope assemblies (SSA, OBA, HRMA) will also be inspected prior to the start of telescope integration.

## 4.29 Verification of Records

Verification of records is specified whenever it is necessary to compare two or more documents to each other in order to assess compliance with a requirement. Common examples of the way verification of records is used for the telescope include:

- Examining drawings for features required by specifications such as redundancy and circuit protection in heater circuits.
- Examining parts lists for ESD sensitive components.
- Comparing two or more drawings (may include ICD's) to each other to assess a mechanical interface.
- Checking personnel records for proper training.
- Checking facilities records for environmental exposure.
- Examining vendor data supplied with parts or materials.
- Verification that analyses meet safety specifications.
- Checking procedures for required controls.

Verification of records is also the final verification method used to prepare the verification report documenting how all requirements have been satisfied.

## 4.30 Demonstrations

Demonstration is not used extensively for telescope verification. In general, demonstration is specified as the method of verification for physical attributes which have no numerical requirements associated with them. This includes qualitative features such as comfort, accessibility, suitability, and adequacy. Demonstration may also be specified for presence or compatibility of shipping containers, handling fixtures, etc. Often, these demonstrations are performed using simulators rather than actual hardware. It is planned that all demonstrations will be performed as part of the manufacturing/assembly process using manufacturing instructions.

## 4.31 Launch Site Verification

The AXAF-I arrives at the launch site fully verified and ready for flight except for fueling and ordnance installation/connection. The following launch site tests verify continued AXAF-I capability.

### 4.31.1 Abbreviated Functional Test

This test assures that the facility arrived at the launch site with no shipping damage and in proper working order.

### 4.31.2 Fuel Propulsion System

This operation includes a working (flight) pressure demonstration and leak test prior to fuel loading. Fuel samples are taken before and after loading, and are analyzed for contamination and correct content.

### **4.31.3 AXAF-I/Upper Stage Interface Tests**

AXAF-I is mechanically and electrically mated to the upper stage and the power, command, telemetry, data and simulated ordnance firing checks verify the interfaces.

### **4.31.4 AXAF-I/OCC/DSN Compatibility Checks**

This test verifies command and telemetry compatibility between the OCC, DSN and AXAF-I using KSC communication interfaces.

### **4.31.5 Orbiter Mechanical/Electrical Interface Verification Using CITE**

The Cargo Interface Test Equipment (CITE) in the VPF is used to assure that the AXAF-I and Upper Stage are compatible with the Orbiter interfaces.

### **4.31.6 Orbiter Interface Verification**

After installation of the AXAF-I and upper stage into the payload bay, the electrical interfaces are verified. These interfaces include the Orbiter flight system and the umbilical through the T-0 connectors.

### **4.31.7 End-to-End Data Test**

This is the last time the AXAF-I/OCC/DSN compatibility test is performed. This test includes the Orbiter communication systems as well as the KSC ground and space links.

### **4.31.8 Countdown**

The AXAF-I launch team supports the countdown with payload readiness status as requested by the Orbiter Test Conductor. battery temperature and propulsion system pressure and temperature are monitored as required to assure safety and maximum capability.

### **4.31.9 Launch**

During liftoff, selected Facility telemetry points will be monitored to verify that the AXAF-I incurs no damage or loss of capability during launch.

## **4.32 On-Orbit Verification**

On-orbit verification consists of performing activities necessary to verify the operational readiness of all systems. Systems verification will generally be accomplished through systems activation and calibration. Redundant systems will not be verified unless primary systems malfunction and redundant systems are required to achieve operational readiness. Verification activities are performed during three periods: (a) with the payload in the Orbiter bay, (b) with the payload deployed on the remote arm, and (c) the payload released from the Orbiter.



Verifications performed with the payload in the Orbiter bay are:

- a. Main busses power on from Orbiter power.
- b. Communications through Orbiter with ground systems established.
- c. Data systems activated and operational.
- d. Systems powered from internal batteries and are operational.

Verifications performed with the payload deployed and attached to the remote arm are:

- a. Direct communications with ground systems established.
- b. Solar arrays deployed.
- c. Appendages deployed.
- d. Systems control from the Operations Center.

Verifications performed after release from the Orbiter are:

- a. Systems activation and calibration.
- b. Charging of batteries via solar arrays.
- c. Attitude determination.
- d. Science instruments activated and calibrated.

**EXAMPLE**

## 5.0 ST ASSEMBLY AND VERIFICATION ORGANIZATION AND STAFFING

The complexities of the ST present engineering, scientific, and management challenges which require planning and implementation in order to meet program objectives. This management and staffing support section describes the approach, organization, tasks, and manpower required to support the Assembly and Verification (A&V) activities to be accomplished at the site of the ST Integration Contractor, Lockheed Missiles and Space Company (LMSC) in Sunnyvale, California. Temporary short term support will be provided as required prior to start of SSM Test.

### 5.1 ST Program Management

ST program management and established contractual arrangements do not include provisions for a ST prime contractor responsible for system level integration, assembly, and verification. ST A&V is planned to be accomplished through the coordinated efforts of a number of responsible agencies and contractors located on-site at the facilities of the ST Integration Contractor, LMSC, in Sunnyvale, California.

Contractual obligations between the National Aeronautics and Space Administration (NASA) and a number of Associate Contractors or agencies provide for the design, development, manufacture, and checkout of major ST hardware/software elements of Contract End Items (CEI's). Upon completion, CEI's are formally accepted by NASA and will be provided to LMSC as Government Furnished Equipment (GFE). LMSC will, with the support of NASA, European Space Agency (ESA), and the Associate Contractors, integrate the CEI's together with the Support Systems Module (SSM) to make up the ST. This integration process, referred to as the ST A&V Program, will produce the assembled and tested ST ready for delivery to Kennedy Space Center (KSC) for launch as an STS payload.

Major ST CEI's, along with the responsible contractor or agency include:

CEI	Associate Contractor	Agency
Support Systems Module (SSM)	LMSC	NASA/MSFC
• Solar Array (SA)	British Aerospace	ESA
Optical Telescope Assembly (OTA)	Perkin-Elmer	NASA/MSFC
Scientific Instruments (SI's)		NASA/GSFC
• High Speed Photometer (HSP)	U. of Wisc.	
• High Resolution Spectrograph (HRS)	BASD	
• Faint Object Spectrograph (FOS)	UCSD/MMC	
• Wide Field/Planetary Camera (WF/PC)	JPL	
• Faint Object Camera (FOC)	Dornier	ESA
• SI Control and Data Handling (C&DH)	IBM/FSC	NASA/GSFC

Each of the Associate Contractors and agencies shown, under the direction of the MSFC ST Project Office, must provide technical capabilities and manpower necessary to support the ST A&V program at the LMSC facility. The schedule for the related activities are defined on Figure 3-1 of this plan.

Test Management will be provided by LMSC as described in Section 4.4. Test scheduling will be coordinated and performed by LMSC in daily meetings. All associates will participate, and all Government organizations will support as required. Disagreements between LMSC and other associates will be adjudicated by the MSFC resident representative. Disagreements between GSFC associates will be adjudicated by GSFC in real time where possible, and otherwise off-line. In the latter case, LMSC will make real time adjustments in the daily test schedule. MSFC representative decisions not acceptable to other Government Agencies will be elevated to off-line MSFC Management with corresponding real time impacts on daily schedules.

## **5.2 ST Program Office Management**

MSFC ST Program Office Management will include on-site and MSFC located personnel. On-site personnel will be provided from the Resident Manager's Office (TA05), the Support Systems Module Office (TA31), the Optical Telescope Assembly Office (TA61), and the Systems Engineering Office (TA81), and will report through the resident Manager's Office. Organizational relationships are shown in Figure 4-1.

### **5.2.1 Resident Manager's Office**

This office will provide on-site ST Project Office support and direction, as required, in support of all on-site personnel and activities, this will include coordination of activities relating to other Government agencies.

### **5.2.2 Systems Engineering Office**

This office will provide Systems Engineering support to the on-site teams at the contractors' facility, Sunnyvale, California. On-site management activities will be coordinated through the Resident Manager's Office.

## **5.3 MSFC Science And Engineering**

The A&V activities at LMSC will be supported by on-site S&E personnel.

### **5.3.1 Space Telescope, Chief Engineer's Office**

This office will provide chief engineer on-site support and direction to the S&E personnel on-site to support the A&V activities at LMSC.

### **5.3.2 Science And Engineering Laboratories**

S&E labs will provide on-site support during the A&V activities at LMSC as required.

## 5.4 LMSC ST Assembly And Verification Organization

Overall technical direction of the ST Assembly and Verification (A&V) operation is the responsibility of the SSM/ST Contractor A&V organization and its manager. The ST A&V organization as provided by LMSC is presented in Fig. 4-2. Associates are required to supply personnel for test design, data analysis, off-line test operations and support engineering, and appropriate management interfaces. Organizational details and responsibilities of the ST Verification Team (STVT) are described in paragraphs 4.4.1 and 4.4.2. LMSC responsibilities are described in paragraph 4.9.

### 5.4.1 ST Verification Team (STVT)

Each associate will have a minimum of one representative on the STVT. The coordination and integration of specific A&V activities is the responsibility of the LMSC ST Verification Team Leader (STVTL), who is a member of the LMSC A&V Test Engineering and Data Analysis organization (ref. Figure 4-2, SSM/ST Contractor A&V Organization). Associate representatives will be supported in all functions by an Assistant STVTL. Support will also be provided by the Test Design Team Leader (TDTL) responsible for the integration and coordination of the A&V Automated Test Design and Data Analysis. The STVT is comprised of all personnel required to implement operations and test.

At the appropriate time in the verification cycle, portions of the STVT (LMSC and associate personnel) will travel to the ST Operating Control Center (STOCC) to support STOCC-to-ST Compatibility testing. Subsequent to ST shipment to KSC for launch, the STVT will be relocated as appropriate to the STOCC and KSC. The STVT will assist the STOCC personnel in the ST Launch Base Verification and Data Analysis and in OV.

The STVT consists of the following personnel:

- Verification Team Leader (SSM/ST Contractor)
- Assistant Verification Team Leader (SSM/ST Contractor)
- Data Team Leader (SSM/ST Contractor)
- Test Conductors (SSM/ST Contractor)
- Test Engineers (SSM/ST Contractor and Associate Contractors)
- Test Designers/Data Analysts (SSM/ST Contractor and Associate Contractors)
- SATS Controllers (SSM/ST Contractor)
- Test Technicians (SSM/ST Contractor and Associate Contractors)
- Mission Operations Representatives (SSM/ST Contractor and Associate Contractors)
- VAP-CS Controllers (Associate Contractor)
- CTV Operating Personnel (GSFC Contractor)

### 5.4.2 SSM/ST Integration Contractor Support

The SSM/ST Integration Contractor will provide the STVT with System Engineering, GSE/STE Engineering, Design and Development Engineering, Product Assurance, Safety, Facility Operations, Software Integration and Development and Operations Planning Support. Responsibilities of the STVT include:

- Scheduling of support services, equipment and facilities
- Manual Test Procedures (TPs) & Technical Instructions (TIs)
- Pretest readiness and daily status meetings

- ST A&V Plan
- Analysis of the ST Verification Requirements and Specifications Document and design documentation leading to development and implementation of requirements for support systems, test software, facilities, TIs and TPs
- Development of automatic test segments
- ST verification team operation instructions prepared for each major test, support and conduct of real time testing (through OV), and evaluation and documentation of data discrepancies
- Test planning, including development of timelines and support system and facility usage requirements
- Scheduling of test operations
- Coordinating Associate Contractor and the ST Contractor test support
- Scheduling and Chairing ST pretest and post test meetings
- Developing, scheduling and implementing pretest and fault-isolation operations (including work around plans)
- Inputting to ST Verification Reports, Project Review Information and Acceptance Data Package (ADP)
- TIs to perform various manual operations
- Directing and conducting all ST tests and demonstrations
- Coordinate CTV and GSE/ST operations

The Data Team Leader (DTL) will be the primary contact for the Associate Contractors to make test design changes to the control file and/or request near real time and post test data sorts. Each Associate Contractor is expected to determine the health and status of his equipment by evaluating the data from all test involving his hardware. Should they find a discrepancy during data analysis, the Associate Contractors will document and submit it to the DTL for formalization and issuance to the ST Log Book (LB). At this point, the SSM/ST Contractor paperwork system will monitor and track the open discrepancy, but it will be the responsibility of the Associate Contractors to initiate corrective action or resolution for their problems, working through the STVTL.

## **5.5 European Space Agency**

### **5.5.1 Solar Array**

ESA will direct the accomplishment of the R&I of SA hardware (flight, Ground Support Equipment [GSE] and D-Model Wing) by the British Aerospace [BAe] verification team in the Vertical Assembly and Test Area (VATA) at LMSC, Sunnyvale, California. The SA R&I activities include those shown in Table 4-1 and staffing requirements are shown in Table 4-2.

ESA will direct the accomplishment of the SSM/ES SA A&V activities by the BAe verification team as covered in paragraph 3.10 relating to the SA D-Model Wing. Task descriptions and staffing requirements are shown in Tables 4-1 and 4-2 of this plan.

ESA will direct the accomplishment of SA activities during the ST A&V activities by the BAe verification team as covered in paragraphs 3.20 through 3.30. Task descriptions and staffing requirements are shown in Tables 4-1 and 4-2 of this plan.

### **5.5.2 Faint Object Camera**

ESA will participate with the SI Contractors' verification team and GSFC in the R&I activities as shown in paragraph 3.5.

ESA will participate with the SI Contractors' verification team and GSFC during the SSM/ES-SI and ST A&V activities covered in paragraphs 3.7 through 3.30 as related to the FOC SI. Task descriptions and staffing requirements are shown in Tables 4-1 and 4-2.

## **5.6 Associate Contractors**

### **5.6.1 Perkin-Elmer (OTA)**

The OTA verification team will be responsible for the accomplishment of the R&I of the OTA, OTA ES, and associated GSE in the VATA, Building 156F at LMSC, Sunnyvale, California. The OTA R&I activities include those shown in paragraph 3.6. The activities will be accomplished in accordance with a detailed work schedule provided by the OTA verification team. Detailed task descriptions are shown in Table 4-1, and required staffing is shown in Table 4-2.

The OTA verification team will be responsible for accomplishment of OTA hardware related activities during the ST A&V, as covered in paragraphs 3.11 through 3.30. Task descriptions and staffing requirements are shown in Tables 4-1 and 4-2.

### **5.6.2 Scientific Instruments**

The SI Contractors' verification teams, under the direction of GSFC, will be responsible for the accomplishment of the R&I of their SI and associated GSE in Building 156F at LMSC, Sunnyvale, California. The SI R&I activities include those shown in paragraph 3.5. The activities will be accomplished in accordance with a detailed work schedule provided by the SI Contractor's verification team. Detailed task descriptions are shown in Table 4-1 and required staffing is shown in Table 4-2.

The SI Contractors' verification teams, under the direction of GSFC, will be responsible for activities relating to their SIs during the SSM/ES-SI and ST A&V activities covered in paragraphs 3.7 through 3.30. Task descriptions and staffing requirements are shown in Tables 4-1 and 4-2.

## **5.7 SSM/ST Contractor Organization (LSMC)**

Four (4) basic groups within the SSM/ST Contractor ALV organizational structure provide the resources and expertise to satisfy the LSMC ST A&V objectives. The two groups under Test Engineering and Data Analysis form the verification and test data teams, and are directly involved with the development and performance of the SSM/ST test program. This test program will be jointly developed by ST program contractors, based on an extensive exchange of data and requirements.

The other two groups under the A&V Manager, Test Operations and Support Engineering/Test Control Center, form the test operations and GSE/STE engineering organizations. They are primarily responsible for the ST physical assembly work and the design, operations and maintenance of the test equipment and facilities. These groups provide a key support role to the ST Verification Team (STVT) in operating the Spacecraft Automated Test System (SATS) computer complex and its ancillary equipment along with maintaining control of the Verification and Assembly Test Area (VATA).

Other SSM/ST Contractor organizations, Figure 4-2, will provide support to the A&V Manager, such as Systems Engineering, Design Engineering, Product Assurance, Mission Operations, and Flight Software Validation.

### **5.7.1 Test Engineering And Data Analysis Organization**

This organization consists of two team-type groups. The unique feature of these teams is that they will be comprised of both the SSM/ST Contractor and supporting Associate Contractor personnel, with a common purpose to satisfy the ST A&V requirements. These teams will be comprised of Test Conductors (T/C), Test Engineers, Test Designers, Data Analysts, the STVT and Test Data Team Leader (TDTL).

#### **5.7.1.1 Verification Team**

This team consists of the STVTL, Assistant STVTL, Test Conductors and Engineers. They have the responsibility for the A&V operations to make certain the A&V program is completed by performing detailed planning, preparation of T/Cs, test conducting, and inputs to timelines. In addition, this group leads troubleshooting and affects work around schedules. They coordinate with all SSM/ST Contractor and Associate Contractor groups as necessary to implement the A&V program. Paragraph 4.4 discusses the STVT operations performed by the Verification Team.

#### **5.7.1.2 Test Design And Data Analysis Team**

This team will integrate the ST automated test design and test data analysis and provide test support during periods of SATS computer on-line testing.

Specifically, the team will be responsible for the generation of automated test procedures, the associated control and limit file (CLF) and test data bases. Typically, these test data bases include telemetry and GSE monitor calibrations, instrumentation information (telemetry format description), logic model, cathode ray tube (CRT) page makeup, etc. Support provided to the T/C and STVTL during periods of automated test will include any real time and post test data analysis.

### **5.7.2 Test Operations And GSE/STE Engineering Organization**

This organization consists of two groups chartered to design, develop and check out SSM/ST GSE and STE for system assembly, verification and ground and launch operations, and implement ST sites activation, final stacking and assembly, verification, ground and launch operations consistent with the A&V schedule.

Both groups in this organization will be staffed by the SSM/ST Contractor personnel who will coordinate and integrate the SSM/ST Contractor and Associate Contractor hardware requirements into the design and operation procedures of the GSE/STE which will be used at STAVF and KSC.

### 5.7.2.1 Test Operations

This group includes Log Book and assembly work instruction planners, mechanical and electrical technicians and the shop support personnel. They are responsible for A&V activities performed on the SSM/ST at STAVF. A limited number of personnel will travel to KSC to assist in the launch operations activities. The responsibilities of this group include:

- SSM/ST ground operations (e.g., handling, cleaning, stacking, assembly, demating, etc.) inputs to the SSM/ST A&V plan.
- Analysis of SSM/ST VRSDs and design documentation leading to the development of TIs and mechanical TPs.
- SSM/ST and Space Support Equipment (SSE) assembly, handling and mechanical operations procedures.
- Log of Operations (LOO) for the SSM/ST and the support system.
- SSM/ST handling, cleaning, equipment installations/removals and related ground operations to support SSM/ST A&V, except SIs, Rate Sensing Units (RSUS), and Fixed Head Star Tracker (FHST) installations.
- Operating, maintaining and calibrating SSM GSE/STE.
- Analyzing the SSM/ST A&V plan leading to inputs to detailed timelines.
- Integrating the Associate Contractors' receiving and inspection (R&I).
- Off-loading and in-plane transfer of the SSM/ST Contractor and Associate Contractor equipment and GFE components (including OTA, SIs, Solar Arrays, and Scientific Instruments Command and Data Handling (SI C&DH) and their GSE).
- Operating and maintaining the SSM/ST Vertical Assembly and Test Area (VATA).
- Operating and maintaining the VATA bridge crane.
- Spares storage and tool crib operations.
- SSM/ST Log Book and engineering data maintenance to support SSM/ST and support systems.
- Plans and procedures for ST ground/launch site operations and ground portions of in-orbit maintenance operations.
- ST off-line operations at KSC and support of on-line operations at RSC.
- Recovery and refurbishment of SSE.
- Coordination for acoustic and thermal vacuum test chamber usage. Actual test facility operations will be performed by the SSM/ST Integration Contractor support organization.



### **5.7.2.2 Support Engineering And Control Center**

This group includes Engineering and Test Control Center (TCC) personnel responsible for designing, verifying, and maintaining all ST GSE/STE.

The responsibilities of this group include:

- Reviewing and analyzing SSM/ST GSE/STE requirements, developing design criteria and test requirements.
- GSE/STE system design analyses, trade studies and cost effectiveness analyses.
- GSE/STE inputs to data requirement (DR) documents, GSE model specification, plans, requirements analysis documents, ICD and specifications.
- Preliminary and detail design documentation for SSM/ST GSE/STE.
- Engineering representation to Program Article Master Schedule Committee (PAMSCO) functions for GSE/STE, to the SSM/ST Contractor GSE/STE Design Change Board (DC8), and SSM/ST Configuration Control Board (CCB).
- Technical support for all manufacturing and testing of GSE/STE and support procurement.
- GSE/STE engineering support from assembly, test and launch operations of the ST and return of the GSE and SSE to the STAVF.
- On-site design engineering support/consultation during GSE/STE verification, during initial use of GSE/STE items at the STAVF and launch site and during all subsequent critical operations involving GSE/STE.
- Operating and maintaining the ST TCC, including support to pretest activities (software and procedures), real-time testing and post test activities (data sorts, plots and playbacks).
- Maintaining GSE/STE documentation (specifications, schematics and drawings) from initial release through the period of the contract.
- Inspecting and testing requirements for the ground equipment to be modified, fabricated or procured.
- Monitoring and coordinating all manufacturing, test and support GSE/STE and support/assist procurement.
- Monitoring SSD operating systems changes to internal documents and evaluating the change for ST contractual requirements.

### **5.7.3 ST Support Organizations**

During the test operations, the SSM/ST Contractor Systems Engineering, Design Engineering, Product Assurance, and the Mission Operations Contractor, and software development organizations will assist the A&V organization. Normal SSM/ST Program Controls and coordination will continue through the operations phase.

### 5.7.3.1 Systems Engineering

The SSM/ST Systems Engineering personnel provide system design, performance and verifications requirements, system characteristics and constraints. They provide the prediction and evaluation of total system performance based on existing designs to assist in achievement of program objectives and resolution of anomalous conditions. System Engineering responsibilities include:

- Developing and issuing the VRSD that provides the basic A&V requirements for development of TPs and TIs.
- SSM/ST performance and characteristics analyses, based on component, software, subsystem and Associate Contractor analytical and test results.
- Total systems evaluation.
- Trade studies to evaluate directed or proposed changes, or to solve problems involving performance deficiencies.
- Chair test Certification Board (TCB).
- In-process design audit activity (consisting primarily of reviews of Engineering Change Proposal [ECP] design activity resulting from Marshall Space Flight Center [MSFC] direction or corrective actions related to hardware or software problems.
- Validating of verification data from tests or assessments by reviewing methods, factors, criteria and assumptions used in producing the data.
- Preparation of Supplement Technical Instructions (STIs) during in-process A&V providing technical requirements for anomalous conditions evaluation, retests, hardware replacements, design change verification and general system testing requirements directions.
- Overall ST system compliance based on valid incremental verification data produced by the SSM/ST Contractor, Subcontractors, Associate Contractors, NASA Standard Equipment Contractors and NASA centers.
- Conduct operational readiness inspections (ORI).
- Certifying flight readiness.
- Monitoring all test activity.
- Reviewing and approving all ST verification documentation (i.e., TP, TPCN, OPO, LOO, etc.).
- Auditing the design of both integration and Associate Contractor GSE/STE designs.
- Tracking open Data Discrepancies (DD), approving closure and presenting DD to NASA.
- Furnishing environmental test inputs, test supports and post test report.

### 5.7.3.2 Design Engineering

The basic objectives of the design engineering organizations are to plan, direct and provide engineering designs and development to satisfy Program requirements for SSM/ST. Although most of the design engineering effort is accomplished prior to A&V, their responsibilities during A&V include:

- Maintaining, reviewing and updating test requirements and procurement documentation of Contract End Items (CEI).
- Monitoring subcontract and government furnished equipment (GFE) management for mechanical and electrical interfaces.
- Coordinating with Systems Engineering on the interface control documentation and incorporating analyses in design.
- Providing engineering services to the test facilities.
- Directing, coordinating, analyzing, reviewing and approving engineering and space technology (analyses), design data, reports, and supporting systems.
- Design material including trade studies and design rationale.
- Monitoring technical progress and interfaces of SSM supplied GFE for compatibility with overall SSM CEI's.
- Participating in DD troubleshooting, failure isolation, problem identification, repair or rework, reverification and closure of DD.

### 5.7.3.3 Product Assurance

The Product Assurance (PA) organization is responsible for SSM/ST safety, reliability, maintainability and quality assurance plans for the SSM and the integrated ST. These plans will use established systems, standards, procedures and instructions, tailored to meet specific ST requirements. The PA responsibilities include:

- Providing quality engineering specialist support for SSM/ST operations.
- Documenting and closing out NCR and failure/analysis reports.
- Establishing procedural and motivational tools to achieve the safety, reliability, maintainability and quality objectives of the ST program.
- Integrating PA responsibilities and activities with other organizations to eliminate or minimize activity which could result in duplication of efforts.
- Monitoring interfaces between the SSM and Associate Contractors and between ST and the space transportation system.
- Establishing a ST safety program to identify and eliminate or control potential hazards associated with the ST system that could result in injury or fatality to the flight crews,

or damage to the ST system elements or launch base facilities. Include hazards that might be transferred to or from the SSM across each of the interfaces.

- Providing personnel to witness tests and work performed on SSM/ST flight hardware and GSE.
- Providing surveillance to verify all SSM/ST documentation is properly filled out and changes, if any, incorporated.
- Maintaining custody of completed SSM/ST Log Book sections.
- Maintaining a reliability program through continuing evaluation of subsystem and hardware design, design changes trade studies.
- Timely status reporting and interval auditing of reliability activities.
- Assuring environmental and cleanliness controls are maintained.
- Tracking DDs and participating in fault isolation, rework, reverification and closure of DDs.

#### **5.7.3.4 Mission Operations Contractor**

The Mission Operations Contractor shall establish a series of commands and scheduled events per the scientific community requirements which will control the ST in orbit. This activity includes operations with the ST at STAVF and KSC.

The Mission Operation activities, prior to acceptance of the ST as an operational observatory, are in support of the STVT. The following are Mission Operations areas of responsibility:

- Integration site (STAVF) test coordination - MOC will support STVT in the coordination activity. The lead role in test coordination will be STVT. MOC will represent GSFC in this activity.
- STOCC to ST communications verification - MOC will include in Operations Procedures to be generated for each test, those steps necessary to establish and maintain STOCC to ST communications. STVT will provide support at the Sunnyvale end.
- STOCC/ST integration testing coordination - MOC will support STVT in the coordination activity. The lead role in test coordination will be STVT. MOC will represent GSFC in this activity.
- STOCC/ST integration test plans and procedures - MOC will generate procedures and scripts to control operations at the STOCC, and STVT will generate Test Procedures for use with SATS. The SATS Test Procedure will include germane entries which have been coordinated between the STVT and MOC.

#### **5.7.3.5 Flight Software Validation**

The flight software development organization is responsible for the development and verification of the SSM flight software, the SI C&DH, DF224, and NSSC-I interfaces, and A&V is responsible for the flight software validation using test methods.

The intent of the approach outlined below is to provide a reliable test method for demonstrating that the SSM flight S/W complies with requirements. Formal verification and validation of the requirements shall normally be by analysis, inspection, demonstration, and test methods. Test plans, test procedures, and test reports shall be used to control, execute and document the SSM flight S/W requirements validation effort by the test method.

The test method shall consist of operating portions of the SSM flight S/W in order to collect the necessary data required to validate the SSM flight S/W which includes interfacing with other flight software. Detailed evaluation of these data shall be performed to determine that the results satisfy these requirements. Specific input values are used to exercise specific segments of the program code and generate specific outputs. Use of this method includes a review of normal program expected output data as well as memory dumps, and other diagnostic information produced during test execution.

QA will monitor design and testing, correlate test results and analysis, maintain change control, and maintain documentation of same. QA's role is more fully described throughout Section 6.0.

The test items and the associated requirements are then verified by examination and comparison with expected/predicted output values. The appropriate techniques for the application of this method of requirements verification shall include the following:

- Tests that demonstrate proper data flow between routines, modules, programs, and data structures.
- Evaluation of test data to determine that output data, listable outputs, and display outputs are in the proper format and have proper values.
- Tests to indicate that the correct SSM flight S/W control and program logic paths are taken through the code in response to specified input values.
- Tests to show program execution within an allowable time span and the required accuracy under loaded conditions.
- Tests that show that given specific input values, specific output values will result.

## 6.0 ST OPERATIONAL RELATIONSHIPS

This section outlines the ST operational relationships between the SSM/ST Contractor, Associate Contractors, European Space Agency (ESA) and NASA. The Space Telescope Verification Team (STVT) will be expected to support the regularly scheduled coordination and scheduling meetings. These meetings will provide the communication channels for the STVT to input requirements or changes to timelines, daily work schedule, operational constraints or organizational policies. The SSM/ST Contractor will convene, chair and document all coordination meetings, recognizing that any STVT member has the option to request such a meeting in his own behalf. Should there arise an issue that cannot be resolved at the STVT level, the issue will be escalated to the NASA ST Project manager.

It is recommended that each Associate Contractor will provide an on-site representative, sufficiently in advance of their hardware delivery, to coordinate technical and administrative details. This individual will be expected to work closely with the STVT test design group to develop integrated verification routines in behalf of his equipment. Test routines for the SI system will have been developed by VAP SI I&T engineers. Another of his responsibilities will be to become familiar with the STAVF and its operating procedures to assist in the transition and arrival of the flight hardware and support personnel.

Schedule control will be accomplished through daily and weekly reviews conducted by the ST Assembly and Verification (A&V) organization with the Associate Contractors, the SSM/ST Contractor Program Office, and NASA/ESA representatives, as necessary. Workaround plans will be developed to assure meeting project milestones. Detailed schedules will be prepared for all A&V activity which includes planning, procedures, assembly, test, operations, data analysis and report generation.

The SSM/ST Contractor will provide training programs to familiarize Associate Contractor, NASA, ESA, AFPRO and SSM/ST Contractor personnel with safety policies, clean room operations and ST handling operations.

Safety training is an ongoing program, but all personnel involved in A&V activity will be required to attend a facility safety training course prior to performing any "hands-on" operations. All personnel who have access to the clean rooms used for any ST A&V will be required to attend a training session prior to certification for admittance to the clean room.

ST handling procedures will be generated for all ST mechanical and electrical operations. All personnel operating any test or facility equipment will be required to attend training sessions.

A training program will also be provided to familiarize Associate Contractors in the use of the Spacecraft Automated Test System (SATS) hardware and software before actual tests are performed. Included in this program will be any language required for communication with specific pretest, real time and post-test ground test software as defined in Section 8.

Hardware and software safety considerations are delineated in SSM/ST Safety Requirements Criteria, LMSC/D758711, SSM/ST Product Assurance Plan PA01; System Hazard Analysis, Design, Integration, and Operations, PA13. Contamination is discussed in ST Contamination Plan, PA02.

### 6.1 STVT Scheduling And Review Meetings

The effectiveness of conducting the everyday SSM/ST A&V business will depend on how planning and scheduling details are handled by the STVT. In order to provide consistency, several management techniques will be employed to organize the SSM/ST activities. These techniques will take the form of timelines, schedules (long range and near-term) and coordination meetings. Timeline and schedule development will be a joint effort by the STVT on a continuing basis. This process will require the

definition of all A&V at the SSM/ST level, with which any or all Associate Contractors will have involvement, in sufficient detail to develop integrated timelines.

Once the timeline has definition, it will be applied against a calendar (work days and shifts/day) to develop an SSM/ST work schedule. This schedule will help define major milestone completion dates, supporting document need-dates (TPs, calibration data, etc.), heavy test periods, and any other time-phased activity required to support the SSM/ST A&V cycle.

Although the SSM/ST timeline and overall schedule will be the basis for planning A&V, it is recognized that because of unforeseen equipment failures and troubleshooting, there will be interruptions in the replanned schedule. Therefore, schedule coordination meetings will be held daily to effect the real-time changes to the SSM/ST schedule and develop workaround plans. At such meetings, the STVT will be appraised of the problem and the schedule impact caused by the failure.

Additionally, there will be coordination meetings dealing with pretest readiness and test certification matters which will involve the STVT. These meetings will deal with specifics of a given test and pass technical judgment on the successful completion of previously performed tests.

### **6.1.1 Timeline Development**

The ST A&V timeline will be developed from the baselined A&V schedule (ref. Figure 3-1). The A&V organization will analyze each schedule element in an effort to define the major tasks required to complete that element. Once the tasks are identified, they will be organized into a logical flow which will take into account facility design, GSE/STE design, manpower limitations and schedules. Next, the interdependency relationship between the tasks will be examined to determine if the tasks have to be performed sequentially or parallel during the ST flow. The final step in the timeline development is to estimate the amount of time (shifts of work) required to perform each sequential and parallel task, thus producing the total estimated amount of time for that schedule element. This total time will then be compared to available calendar time (days) to determine if the standard 5 days 2-shift work week will satisfy the projected work load.

### **6.1.2 Daily Work Scheduling**

Starting with facility activation, and continuing through Orbital Verification (OV), weekly A&V scheduling meetings will be held to plan the work for the following week, using detailed timelines. The meeting will be chaired by the ST Verification Team Leader (STVTL) and attended by the SSM/ST Contractor representatives from Systems Engineering, Programs Controls, Design Engineering, Product Assurance, Test Engineering and Data Analysis, and Assembly, Verification and Ground Operations. Each Associate Contractor will also be represented during the ST A&V operations. STOCC personnel, which includes the SSM/ST Contractor and OTA Associate Contractor, will also be represented during the period of STOCC ST testing, launch and OV. It is anticipated that the NASA A&V representative will participate in these meetings.

Daily scheduling meetings will be held by the STVTL with the same attendance as for the weekly meetings. During these meetings, the status of the A&V for the prior work day will be reported. A two-day work projection will also be prepared, based upon the Weekly Schedule and the status of the prior work day. Any operational problems and workaround plans will be discussed, and this work will also be scheduled.

### **6.1.3 Pretest Readiness Meeting**

The Pretest Readiness Meeting (PRM) is called and chaired by the ST A&V organization for the express purpose of briefing the ST test conductor(s), reviewing the detail status of the GSE/STE, test design,

software, procedures, and developing a detailed verification "road map". This road map will describe the verification activity on an hour-by-hour basis and identify for each associate when his operational personnel are expected to be directly involved in on-line operation, as opposed to being in a monitor mode. During this meeting, all involved parties will have an opportunity to participate in evaluating the proposed verification road map and to suggest modifications/changes needed to accommodate hardware configuration and/or support personnel limitations. The PRM is intended to be less formal than the Test Certification Board (TCB) meeting and to deal with an order of magnitude greater detail. It is anticipated that it will be an open forum for the test designers, programmers, software and hardware personnel to exchange last minute concerns and information which will help the pending verification cycle run smoothly.

For purposes of predicting the PRM schedule, a double setback technique will be used to forecast the time for the PRM. Normally, the PRM occurs 3 or 4 working days prior to a "powered on" verification activity. Therefore, initial notification of all STVT members about a forthcoming PRM will take place during the normal course of business at the daily scheduling meeting. The PRM will be placed on the schedule approximately one week prior to its preplanned time (i.e., 1 week + 4 days). This allows ample time for all parties to prepare for the meeting and maintains significant schedule flexibility to respond to last-minute delays introduced into the schedule by the hardware, software and/or GSE/STE failures.

The STVT and facilities operations personnel (i.e., SATS, TV Chamber, Acoustic Cell, etc.) will also participate in the Pretest Readiness Meeting. Each member will be expected to status his area of responsibility and identify situations that might impact the planned verification.

The meeting agenda will address four major topics:

- Identify test purpose/objective
- Establish flight- and test hardware level of readiness (including identification and status of the software and documentation to be used during the test)
- Identify personnel duties and responsibilities required to support the test
- Lay out a schedule for test completion

Upon completion of this meeting, everyone should understand the "How, What, When and Where" mechanics of the pending verification activity.

## 6.2 Test Certification Board (TCB)

The TCB will be used as a regulatory body for post-test reporting and pretest status during the SSM/ST verification cycle. It will be convened prior to start of each major verification activity, as defined by the Assembly and Verification Schedule (Figure 3-1). The TCB will be chaired by SSM/ST Contractor Systems Engineering. The TCB will be comprised of one designated member from each Associate Contractor, NASA and ESA. Designated members will draw upon their Quality, Systems Engineering, A&V, and Design and Development organizations for technical support. It is expected that each member will provide a written input to the TCB chairman for inclusion as part of the TCB meeting minutes. The written inputs will include assessments of:

- Open or unfinished work and impact, if any, on pending tests
- Discrepancies and impact, if any, on pending tests
- Post test results and status



- Hardware, software and GSE/STE to support the pending test
- Test documentation status
- "OK to proceed" to next test phase

Each participating member of the board will certify hardware readiness for the next verification segment by signing the meeting minutes. The SSM/ST Contractor Systems Engineering organization will publish the TCB meeting minutes and provide distribution.

### **6.3 Data Discrepancy (DD) Reporting And Resolution Procedures**

The DD will be used by the A&V Test Data Team (TDT) to report all anomalies (SSM, SI, OTA, and SI C&DH) detected by analysis of data obtained during testing. The STVTL becomes responsible for the DD investigation and resolution upon receipt of a copy of the DD. Resolution activities that require on-line troubleshooting, analysis by hardware design personnel will be authorized by Supplemental Technical Instruction (STI), Operations Orders (OPOs), Non-Conformance Reports (NCRs), and Software Discrepancy Reports (SDR). If investigation proves the anomaly to be a test design error, the DD will be passed to the Test Data Team Leader (TDTL) for resolution. All DDs issued to the STVTL will be reproduced and distributed to the SSM/ST Contractor Systems Engineering and the appropriate Associate Contractor, NASA and ESA representatives as appropriate. Systems Engineering will track each Spacecraft DD and maintain a summary of open DDs.

A summary of the investigative procedure and tentative resolution will be hand written on the STVTL copy. This copy will be given to the TDTL for review and formalization on the original copy of the released DD. The TDTL and the STVTL will sign the original and the TDTL will deliver it to Systems Engineering for approval and presentation to the NASA representative. Subsequent approvals will require the signature of Product Assurance, Systems Engineering, NASA representative and the appropriate Associate Contractors. The TDT will provide for reproduction and distribution of all completed DDs.

### **6.4 Data Discrepancy (DD)**

The DD form will be used to report anomalies detected by analyses of the telemetry data. The following ground rules control the preparation of DD forms. Each applicable item listed should be included on the DD. All DDs will be clearly handwritten by the Data Analyst and will contain the following information, exclusive of corrective action column entries:

- Time of Year (TOY)
- Test Time ("R" Run Time, "H" Hold Time)
- Data Source (Real-Time List, Post-test Sorts, Analog records, Notebooks)
- Test Run Number
- Complete description of the problem, described in past tense. A description of normal operation will be included.

- Relationship to other events, commands or functions
- Relationship to other DDs
- Relationship to specification performance requirements
- Attachments are used for lengthy discussions of the problem
- Resolution of the problem will not be included

An example of a typical DD is shown in Figure 6-3. DDL flow is depicted in Figure 6-4. The discrepancy will be logged into a summary sheet by the Test Data Team (TDT) and reviewed by the TDT Leader (TDTL) for completeness and accuracy. Data Discrepancies are prepared on DD forms and routed as follows: (1) test design problems routed to the test data team logbook; (2) SATS ground test software problems routed to the SATS ground test software logbook; (3) GSE/STE problems routed to the GSE/STE logbook; and, (4) spacecraft problems (hardware and/or flight software) routed to the master Assembly and Verification (A&V) logbook which is retained at the DD coordinator's work station in Building 579. Problems considered to be spacecraft (Item 4 above) will be reviewed by the STVTL for investigation and resolution. These discrepancies will also be reviewed by Systems Engineering and when appropriate, by the Associate Contractors and NASA. After spacecraft troubleshooting and final closure, the original signed-off copy of the DD will be retained by PA as part of the spacecraft logbook records.

At the completion of each major A&V task, the STVTL and all Associate Contractors will prepare summaries of the operation and provide them to the SSM/ST Contractor Systems Engineering as inputs to the ST Verification Report (DR AV-08).

## 6.5 Non Conformance Report (NCR)

The NCR will be the primary hardware failure reporting document used on the SSM/ST Log Book documentation system and will become a permanent part of the SSM/ST Log Book documentation system. The following scenario on the application and resolution of NCRs is included herein to provide an overview for those involved in the discrepancy resolution process.

NCRs will be generated from (1) results of troubleshooting a DD that verifies hardware anomalous operations; (2) visually observed discrepancies; or, (3) suspected hardware damage or anomalous operations. The procedure for handling the disposition of the NCR is dictated by several criteria as outlined in the Discrepancy Classifications and Disposition Matrix (Figure 6-5).

Typically, for a discrepancy written against a SSM/ST Contractor-built or furnished item, processing of the NCR will fall under the purview of the Material Review Board (MRB). The MRB is comprised of two people, a SSD PA and SSD Engineering representative. MRB responsibilities include:

- Controlling, scrapping or impounding discrepant hardware and pursuing on-the-floor corrective action.
- Assuring that timely action is taken or has been committed to prevent the recurrence of discrepancies
- Implementing corrective action policies established by Corrective Action Board (CAB).

- Dispositioning discrepant items in accordance with this procedure; resolving disposition or assuring appropriate escalation for resolution; and obtaining technical representation from other organizations to determine appropriate disposition of non-conforming material.
- Submitting discrepancies which require NASA/AFQA approval for final processing in accordance with the Discrepancy Classification and Disposition Matrix (Figure 6-5). The SSM/ST Contractor PA representative will be present at the submission or discussion of NCR packages presented for NASA/AFQA acceptance.
- Assuring maintenance of adequate records pertaining to Quality Assurance (QA) and MRB actions

If the NCR investigation leads into a GFE module or component, the STVT will troubleshoot (as documented by OPO) to isolate the problem to the module or component and then support the Associate Contractor with his detailed investigation. If the GFE remains on the SSM/ST, all T/S documentation will be covered by the NCRs and OPOs generated against the discrepancy. Final closure will be handled by the MRB, Associate Contractor, NASA resident representative and Air Force Plant Representative Office (AFPRO) concurrence signatures.

**EXAMPLE**

## 7.0 TEST DOCUMENTATION

The SSM/ST Contractor will use a system of documentation that provides a recorded path of all functions from generation of Assembly and Verification (A&V) requirements through Orbital Verification (OV) of the ST. The test design effort will begin with the preliminary release of the ST Verification Requirements and Specifications Document (VRSD) and design requirements, in the form of ICDs, specifications, and various Data Requirement (DR) documents. The design and system data, the VRSDs, the Associate Contractor test outlines and procedure inputs and the calibration data will be used to prepare the A&V test design logic model and test sequences.

Detailed timelines and Logs of Operations (LOO) will be developed, from the data described above, to implement the A&V activity in a systematic way. The manual operations required to prepare and support the SSM/ST will be outlined and documented by Manual Test Procedures (MTPs) and Technical Instructions (TIs).

As test sequences are developed, they will be integrated into Test Procedures (TPs) designed for specific A&V activities. Power-On TPs will be computer-audited by using pretest computer simulations and audits of the test. The SSM/ST Contractor and the appropriate Associate Contractor engineering personnel will audit the logic model, calibration data and TPs to assure the information accuracy. When the audit cycle is completed, the logic model, calibration data and TPs will be updated and released for review and signature by the SSM/ST Contractor, NASA and Associate Contractors.

### 7.1 SSM/ST Documentation

A&V documentation, as defined in this section, will be the actual "working paper" used to document and verify the work performed on the SSM/ST. The ST Verification Team (STVT) will record on these documents by data entry, signature or Production Quality control stamp to indicate that the authorized work has been performed. These documents will provide historical data to develop inputs for test reports and readiness reviews. All test documentation will be controlled per Product Assurance Plan, PA01.

#### 7.1.1 Manual And Automated Test Procedures

Manual Test Procedures (MTP) are defined as those documents containing instructions on how to perform a given task without support from a computer system. These MTPs will have the test setup instructions, documentation listings, safety requirements, equipment listing and detailed instructions for performing the tasks called out in the body of the MTP. Activity or work instructions integrating assembly and test of Associate Contractor (or affecting Associate Contractor) hardware, shall be prepared. MTPs will be provided for formal Associate Contractor review and approval, prior to their use and will include functions to verify the requirements of the applicable requirements document.

MTPs are supplemental to Shop Work Authorizing Documents (SWAD), i.e., Operations Order (OPO) or Standard Log of Operations (LOO) and, by themselves, do not authorize work but contain detailed instructions to perform a variety of functions. These functions may include SSM/ST A&V activities designed to satisfy engineering drawing and specification requirements or configure the SSM/ST for test. MTPs will provide sufficient detail where possible to eliminate the need for reference to drawings and specifications by using sketches and technical illustrations to supplement the work instructions. MTPs shall be implemented by a SWAD. MTPs prepared under Off-Line Launch Site Procedures (DR OP-04) for use at Kennedy Space Center (KSC) will be of similar content and will be implemented in the same manner.

The Automated Test Procedure (ATP) will be required for computer-supported ST powered testing at the ST Assembly and Verification Facility (STAVF). The ATP will have the Test Control Center (TCC) setup instructions, documentation listings, instructions for performing required manual functions and Product Assurance inspection points. The ATP will have a condensed listing of the test sequences contained in the Control and Limit File (CLF) that is loaded into the test computer for performing the test. The ATP will include the ST real-time and stored program and GSE/STE command sequences, predicted monitor responses, real-time data processing instructions, Cathode Ray Tube (CRT) assignments, etc.

Any hardware design change and/or software on-board modification will be approved by the SSM/ST contractor System Engineering, NASA and the respective Associate Contractor. The VRSD must be revised before the Test Procedures (TPs) will be revised. Hardware and flight software anomalies will be documented on Data Discrepancy (DD) forms or Non-Conformance Reports (NCRs).

They will be dispositioned by the SSM/ST Contractor, with approval from the appropriate Associate Contractor and NASA, prior to revising any TP. The TPs will be updated after initial release only with the approvals described above. When the updated TP is generated, a new revision letter will be assigned and all changes will be identified. Revised TPs will be re-submitted for concurrence by all affected organizations before it is used on the flight hardware. ST Manual and Automated Test Procedures (DR AV-07) are Type 2 documents and Marshall Space Flight Center (MSFC) has the right of disapproval on initial issues and revisions.

It may be necessary to update a TP subsequent to release which will be accomplished by a Test Procedure Change Notice (TPCN). The TPCN will be written to: (1) correct TP design errors detected during the performance of a test, (2) incorporate new test requirements, and (3) incorporate changes required by the use-as-is disposition for hardware anomalies. The TPCN will be approved by a representative of the organizations who initially approved the released document. A maximum of five TPCNs normally are issued before the affected TP will be revised for change incorporation. When the TP is revised, it will be reissued under the next higher letter designation and resubmitted for signatures.

TPCNs fall into three categories:

1. "Incorporate in Next Revision" changes, made to correct errors in procedure for later testing of an identically configured article, or to incorporate changes required due to design changes. This category is signified by a check mark in the TPCN "Incorporate in Next Revision" block.
2. "One CCA Only," issued to describe changes required for a single test having a planned permanent configuration difference. This TPCN describes the special procedure to be used each time the particular test article, identified by a Control Configuration Article (CCA) serial number, is subjected to the test. This category is signified by inserting the letters "CCA" in the TPCN "One Time Only" block.
3. "One Use Only," issued to cover "as-run" procedural changes made to accommodate temporary test configuration deviations, test equipment substitutions, etc. Any subsequent repeat testing reverts to the basic TP (which may have been modified by TPCNs in categories 1 and 2 above). This category is signified by a check mark in the TPCN "One Time Only" block.

Only TPCNs in category 1 are to be counted as part of the five which normally trigger TP revision.

Under normal circumstances, a TP will be utilized in its entirety to perform an installation, an assembly, an alignment, a test, etc. However, non-standard use of the TP is permitted when a portion of the TP is required to be performed, as prescribed in the following paragraphs:

- Non-standard use of or deviations from the TP may be made without effecting changes to the document for subsequent use by one of the following methods. A TPCN will not be required on deletions of this nature.
- When partial configuring of the hardware and/or special testing does not require the performance of all paragraphs of the TP, the SWAD (LOO/OPO) shall specify the paragraphs or items to be performed (or not to be performed). The affected paragraphs shall be annotated in the TP (Log Book Copy) by the Operations Engineer referencing the LOO/OPO and signing and dating the TP entry. No other approvals shall be required on the manual TP for such annotations. In those instances, where a work item prescribed in a TP requires some modification to be used, the LOO/OPO shall authorize the deletion of the entire TP item and the modified version shall be transcribed as a work item on the LOO/OPO to be accomplished in the desired sequence.
- Where one-time only omissions or deletions to the handling instructions of the TI satisfies operational on-the-spot requirements, the Operations Engineer or Test Conductor may delete the item(s). These items pertain to the installation and removal of test or handling GSE/STE. The Operations Engineer or Test Conductor will note the deletion(s) in the TI with remarks, a signature, and the date.

In those cases where TP paragraphs or items or portions thereof have previously been accomplished and accepted, the Operations Engineer or T/C, after verifying the SSM/ST - meets the requirements of the in-process document, may designate the paragraphs or items or that portion of the paragraphs or items having been previously accomplished per LOOXX/OPOXX. The responsible person shall then sign and date each paragraph/item so annotated.

During the preliminary preparation of the TP, periodic TP preparation status and schedules will be used to track the effort. These schedules will be issued weekly, starting with the final preparation period of the first TP through release of the last TP. Schedules will include the due dates for TP inputs, the test preparation milestones and the status of the preparation efforts.

### **7.1.2 Technical Instruction (TI)**

TIs are instructions for certain non-testing operations (not detailed in SWAD or in TPs) required in support of product testing in Systems Test organizations. These support operations are not specific acceptance requirements of the vehicle or product detail specification (or System Test Specification) but must be performed in handling and servicing the product or test equipment. Examples of the types of operations which may be covered by such instructions are (1) vehicle handling, preparation for shipment, etc. and (2) ground recorder checkouts.

TIs are supplemental to SWAD and by themselves do not authorize work but contain detailed instructions to perform a variety of functions. The functions may include SSM/ST assembly instructions, performing the removal/replacement of electronic components, preparing and configuring for test, handling and hoisting operations, etc. TIs will provide sufficient detail to eliminate the need for reference to drawings and specifications using sketches and technical illustrations to supplement the work instructions. TIs shall be implemented by a SWAD.

Under normal circumstances, a TI will be utilized in its entirety to perform an installation, an assembly, an alignment, etc. However, nonstandard use of the TI is permitted when a portion of

the TI is required to be performed. Non-standard use of or deviations from the TI may be made, without effecting changes to the document for subsequent use, by one of the following methods. A TPCN will not be required on deletions of this nature.

When partial configuring of the hardware and/or special testing does not require the performance of all paragraphs of the TI, the SWAD (LOO/OPO) shall specify the paragraphs to be performed (or not to be performed). The affected paragraphs shall be annotated in the TI (Log Book Copy) by the Operations Engineer or T/C, referencing the LOO/OPO and signing and dating the TI entry. No other approvals shall be required in the TI for such annotations. In those instances where a work item prescribed in a TI requires some modification to be used, the LOO/OPO shall authorize the deletion of the entire TI item and the modified version shall be transcribed as a work item on the LOO/OPO to be accomplished in the desired sequence.

Where one-time only omissions or deletions to the handling instructions of the TI satisfies operational on-the-spot requirements, the Operations Engineer or Test Conductor may delete the item(s). These items pertain to the installation and removal of test or handling GSE/STE. The Operations Engineer or Test Conductor will note the deletion(s) in the TI with remarks, a signature, and the date.

In those cases where a TI paragraph or portions thereof have previously been accomplished and accepted, the Operations Engineer or T/C, after verifying the SSM/ST meets the requirements of the in-process document, may N/A the paragraph or that portion of the paragraph, as having been previously accomplished per LOOXX/OPOXX. The responsible person shall then sign and date each paragraph so annotated.

TI revisions are accomplished through incorporation of the required change into the TI master and reissuance under the next higher alpha character (A, B, C, etc.) or by issuance of a TPCN. A maximum of five TPCNs may normally be issued before the affected TP will be revised to incorporate the changes.

### **7.1.3 Operations Order (OPO)**

The Operations Order (OPO) is a work-authorizing document that contains all the necessary instructions and approvals to complete a specific task. The SSM/ST program will use the OPO to document in the SSM/ST Log Book (LB), the standard routine and repetitive tasks which are preplanned and the unscheduled or unplanned tasks resulting from a variance to the preplanned A&V. These standard OPOs serve as supplemental documents to the LOO when additional detail work instructions are necessary. In such cases, the LOO will invoke these supplemental documents by means of a simple one line statement, "perform OPO IX". Standard OPOs derive their requirements from engineering drawings, specifications, VRSDs, etc., (ref. Figure 6-1).

The "unscheduled or unplanned" OPOs will authorize and document troubleshooting, retest and rework type activities resulting from on-line test discrepancies or suspect conditions. They will be broken into subsets within the Log Book depending on the nature of the task or the authorized document, (ref. Para. 6.2.4 and Figure 6-1).

The preparation and use of the OPO for the SSM/ST Program follows a prescribed format that has been proven by long usage. The following overview of OPO preparation and content is provided to familiarize the Associate Contractors with one of the documents used in the "Hand-Off" process to transfer Government-Furnished Equipment (GFE) to the Associate Contractor for problem resolution and repair (ref. Figure 6-2, Operations Order Format).

## **7.1.4 Master Procedure List (MPL)**

The MPL is generated and maintained by the A&V organization responsible for producing the SSM/ST TPs. This document is a listing of all SSM/ST Contractor TPs required to meet the objectives of each phase of the ALV Plan. The MPL will identify the TP number, title and revision letter. The MPL in its original release form, acts as a planning or inventory document to support the development of the LOO. The MPL is updated by a TPCN that is released through the normal approval channel. At the conclusion of the verification cycle, the MPL will be used to demonstrate that the "as-run" TPs agree with the MPL, thus maintaining test documentation control.

## **7.1.5 Test Procedure (TP), Technical Instruction (TI), And Supplemental Technical Instruction (STI) Logs**

The TP/TI/STI logs are individual sections in the SSM/ST LB. Each of the sections has a master log or index sheet which summarizes the content of the section. It will identify the TP/TI/STI by control number, title and revision letter, if any. All entries to these sections will be posted by the A&V Planning organization and audited by QA for completeness and accuracy. The TP/TI/STI are detailed documents designed to support the LOO or established special requirements, and do not authorize work to be done. Only the coordinated and approved LOO or OPO authorizes work to be done.

## **7.1.6 Log Of Operations (LOO)**

The LOO will be compiled to provide a sequential index of all standard work operations to be accomplished. A separate LOO will be prepared for the Launch Site support LB. The LOO will briefly describe the function to be performed and identify any supplemental documents (TP/TI/OPO/STI) to be used in performing the function. The LOO will also indicate the necessary signatures and stamps for "OK to Proceed" where required and include provisions for the required signatures and stamps to show completion and acceptance of the described function.

The LOO will be submitted to the ST/TL and QE for approval prior to release. The Associate Contractors will review and concur with the LOO to assure that their timeline planning inputs have been properly integrated into the LOO.

Changes to the approved LOO will require the same approval signatures as the original LOO prior to submittal. The Log Book Change Request (LBCR) originator shall be responsible for obtaining all required signatures prior to submitting the LBCR to the A&V Planning for incorporation of the requested change into the LOO. The approved changes will not require the LOO to be resubmitted for new approval signatures.

The LOO and required supplemental documents (TP/TI/OPO/STI) will be prepared and coordinated for release by the SSM/ST Contractor A&V organization.

The A&V Planning organization will maintain a "Master" LOO and a file of all LB change requests.

## **7.1.7 Operations Order (OPO) Section**

The OPO sections of the SSM/ST LB will contain OPOs to handle, configure, test or support test-related activities (T/S, retest special test, rework). There will be several types of OPOs which are designed to perform specific functions. Each type of OPO will be categorized and maintained in a separate section of both the STAVF and Launch Site support LBs along with an index page for posting. The A&V Planning organization will post each OPO on the index page and assign it a



number. The index page will also contain the date of posting, work description, date of completion and QA certification.

The SSM/ST Contractor will write OPOs to perform tasks in the following categories:

- Standard Operations Orders. 001-199 OPOs will be written to supplement the standard LOO in performing mechanical, testing or test preparation tasks.
- Troubleshooting Operations Orders. 201-299 OPOs will be written to isolate functional problems or resolution of data discrepancies .
- Special Operations Orders. 301-399 OPOs written as a result of special instructions from Engineering in the form of an STI.

**EXAMPLE**

## 8.0 AUTOMATED TEST METHODOLOGY

ST automated tests will be composed of a series of test sequences for each system or subsystem which may be integrated with other systems or subsystems during the same time-frame. Selected groupings of test sequences will be necessary for a variety of purposes including Verification Requirements and Specifications Document (VRSD) requirements, which when assembled will be classified as Power-On, Functional, Confidence, Environmental, Health and Status or Special tests. In each case the test is computer-controlled through the use of a previously-generated Control File (CF) (reference Figure 7-1). Verification of the CF is by simulation prior to its use by the real-time-test software.

### 8.1 Glossary

The following definitions are provided to assist in the understanding of Sections 7 and 8:

Alarm Limit	A limit applied to a monitor (measurement number) to provide warning of potential hazard to personnel or hardware and to inform the test conductor that some appropriate action is needed on his part. An Alarm Limit is independent of a Performance Limit or Transient Limit (see Performance Limit and Transient Limit).
Analog Monitor	A monitor whose output usually represented in terms of engineering units is proportional to its input function. The monitor may be two or more bits in size and is assigned its own unique measurement number (see Bilevel Monitor & Multilevel Monitor).
Aperture	A tolerance which specifies the minimum deviation from the last data output value which will result in the generation of a new output value (see Data Compression).
Argument	The part of a statement used to inform the software program (usually the real-time program) of the reason (subject) for the action (directive) to be taken. In the control statement, the Argument is preceded by the directive (see Directive).
Bi-level Monitor	A monitor which produces a Bi-Level output representing either of two possible input states which are usually represented by English descriptions. It is one bit of an eight bit word and has its own unique measurement number (see Analog and Multilevel Monitor).
Block Event Code	A unique alpha or numeric identifier assigned to each message type. Each Control File and Test Conductor's instruction not related to data processing is assigned a Block Event Code.
Calibration	It defines the relationship between telemetry output in decimal counts and the input physical function.
Column Mode	A line printer format which displays monitors (measurement numbers) in several columns, according to their first alpha character. Columns may be designated to contain measurement numbers beginning with one or several different alpha characters. The other format for data display is the Line Mode (see Line Mode).

Commands	Instructions to a specimen for the purpose of generating a response or assuring proper configuration. The control may be exercised through the On-Board Computer (OBC), GSE, or manually by test personnel (see Test Sequence).
Command Argument	Information needed by the simulation software to generate 48-bit commands, given on ST Command Mnemonic or nickname (see Command Mnemonic).
Command Mnemonic	An eight character representation of a 48-bit command word (see DM-01). The command word may be discrete or serial digital (see Discrete and Serial Digital Commands).
Command Nickname	Up to an eight character short-form representation of the 48-bit command word (see DM-01). It is formed by combining all upper case alpha characters, numbers, and plus (+) and minus (-) signs of the command name and preceding it by the appropriate subsystem letter code. Reference DM01 for conversion compatibility to STPOCC.
Conditional Verifier	A monitor whose state is changed as an effect of the execution of one or more commands, and/or some other device or monitor state. This other monitor may be: a) a ST hardware monitor, b) a logic model pseudo monitor, or c) an on-board computer software monitor.
Confidence Test	A test used to provide a high degree of confidence within a relatively short time span. This test is typically used after hardware reinstallation or ST movement to a new location. This test exercises systems or subsystems sending commands and verifying monitors, although all redundant paths and all possible modes are not exercised. This test is entered from and exited in the standard configuration (see Entry Point). Confidence Tests may exist on levels, such as a subsystem or total ST.
Configuration List	A pretest listing of the condition or state of the ST or GSE/STE devices at a specified test time which includes Pseudo Monitor states (see Pseudo Monitor).
Constraint	A directive used to indicate that a disallowed command has been issued based on the current hardware configuration. In the SATS system, Constraint directives will specify the action to take, such as hold the test or to inform the test conductor that a constrained command has been issued.
Control Files	Computer files containing the information necessary to control the ST through a preplanned test sequence. Typically it includes TLM format description, monitor calibration data, time-ordered commands (sequence), time-ordered monitor data processing instructions including limits and data display and routing information.
CRT	A Cathode Ray Tube display unit with keyboard entry

Data Compression	A routine to condense data before passing it to subsequent computer routines for data processing (see Aperture).
Delta Limit	A form of performance limit where the range of limit values applied to a monitor is dependent upon the value of the monitor (Measurement Number) when the instruction is initiated (see Performance Limit).
Derived Monitor	A software monitor whose value is derived from a function of two or more hardware Monitors.
Directive	The part of a statement used to inform the software program (usually the Real- Time Program) of the action verb to be taken. In the control statement, the directive is followed by the Argument (see Argument).
Discrete Command	A single function command which configures a device to one of two possible states (see Commands).
Discrete Monitor	A monitor whose output has no Engineering Unit equivalent. Each unique output (range if greater than one bit in size) represents a specific condition or state which is usually represented by an English description. Bi-Level Monitors and Multi- Level Event Monitors are both discrete monitors (see Bilevel and Multilevel Event Monitors).
Engineering Unit Representation	The representation of a monitor output in terms of the physical function which produced the input to the telemetry system. An Engineering Unit representation of a Bilevel Monitor or Multi- Level Event Monitor is the English description of the state represented by the Monitor value.
Entry Point	That point within a Test Segment that can be entered or exited with a standard vehicle configuration (e.g., the beginning of a Test Segment or the end of a Test Segment).
Equation	The Logic Model expression relating a cause to an effect. The cause is usually a combination of commands and/or monitor states and the effect is a Directive that is to be executed as a result of this cause (see Commands and Directive).
Flight/Orbit Simulation	The configuration, environment, interface, and operations a vehicle is normally exposed to during mission operations, simulated as closely as is practical.
Functional Test	A test used to verify or disprove the integrity of the system under test. All commands are functionally exercised (within hardware constraints) and all monitor responses are verified in every state. The various tests may or may not be integrated with other subsystems. A relatively simple subsystem functional test may be completely contained within the ST Confidence Test. The Confidence Test for a system may be a part of the system's complete Functional Test. Functional Tests may exist on different levels such as a subsystem or total ST (see Confidence Test).

GSE/STE Telemetry	Not true telemetry in that no signal is transmitted or received from the specimen, but instead is a bit stream of ground test information.
History File	A computer tape recorded during powered test containing a chronological list of the commands sent, the compressed data, results of the Limit Check routine, and messages.
Hold	A mode in which test time is not advancing and the associated Control File information is not being processed. On-board computer Stored Program Commands will cease to execute (see Test Time, Run).
Limit Check	A technique used in simulation to verify that monitor response to commands and/or configuration is as predicted. The Limit Check is failed when data is outside the range of the lower or upper limits (see Performance Limit).
Limits Listing	A time-ordered listing of Data Processing Directives and Instructions which is a representation of the actual Limit Processing that occurs within the ground software. For example, for Limits and Alarms, the actual Limit Processing time windows are shown along with the changing upper and lower limit values (see Directive and Limit Check).
Line Mode	A format for presentation of data on the printer where information is displayed chronologically down the page. The types of information displayed are monitor responses and Limits, Test Directives executed in the Test Sequence or input by the test conductor, and text statements. The other format for display of data is the Column Mode (see Column Mode).
Logic Model	An assembly of mathematical representations of the test specimen used to predict responses to executed commands. The response to a particular command may vary depending on the specimen configuration. Commands may be specimen, GSE or Pseudo commands that represent specimen configuration changes caused by external inputs. Responses may be Limits, command English descriptors, Constraint violation actions and data processing instructions.
Macro	Fixed grouping of commands, test control directives, and/or data processing instructions assembled and named by a single identifier which may be called into a sequence by a single-request entry.
Manual Test Procedure	A TP used by Test Operations personnel in support of a non-automated ST test.
Measurement Number	A unique alphanumeric identifier (DM-02) assigned to each data parameter (monitor).
Memory Map	A memory map is a listing of the DF224 (or NSSC-1) memory storage areas which specifies by addresses the specific ranges in which certain types of information is to be stored. These types of

information may include Stored Program Command areas, scratchpad areas, data base areas, software program areas, etc. Addresses of write protected areas and areas of items of specific interest (Vehicle Time, etc.) should also be included.

- Multi-Level Event Monitor** A monitor whose output is represented by two to 32 unique telemetry output values or ranges of values, each representing a specific condition or state specified by an English descriptor up to eight characters in length (see Analog Monitor and Bilevel Monitor).
- Pause** A software test directive that stops Test Time from advancing and stops the processing of Control File information, but does not reset the on-board computer pointer to zero or cause ST to go to safemode.
- Performance Limits** Value(s) applied to a monitor output to define the expected range of response of the test specimen. Performance Limits (LIMIT and TRANS) are independent of Alarm Limits (see Alarm Limit).
- Power-On and Conditioning Test** A test used to apply power to the SSM/ST and to configure all ST systems from an unknown state to a standard configuration (see Entry Point).
- Pseudo Command** A Command that is defined as a function of simulation or manually input in the TSI, and is used in other modeling equations. Pseudo Commands represent system/subsystem changes caused by either internal or external stimuli (other than definable ST or GSE Commands (see Commands)).
- Pseudo Monitor** A simulation variable whose state or value must be used in other modeling equations. Pseudo Monitors are used in SATS Logic Models to define conditions which cannot be expressed by using direct relationship statements. Such conditions usually occur when:  
a) commanded devices do not have a direct status monitor (verified),  
b) complex and laborious equations are required to define a state or condition, or c) a test situation must be established that cannot otherwise be defined. Pseudo Monitors may be logical (true or false), integer, or floating point (real) variables only and do not appear in the TLM Instrumentation List.
- Pulse Detect** A technique used to verify a momentary change in state of a Discrete Monitor and the subsequent return during a specified time interval (see Discrete Monitor).
- Real Time** A term signifying presentations by the software system during test, as compared to pretest and/or post-test functions. Real Time presentations may not always be displayed when they occur.
- Real-Time Commands** St Real-Time Commands (RTCs) are Commands executed by the SSM DMS immediately after they are received and verified. RTCs may be Software Commands, Discrete Hardware Commands, or Serial Digital Hardware Commands (see Discrete Command, Serial Digital Command, and Software Commands).

- Run** A mode in which test time is advancing and the associated Control File information is being processed (see Hold and Test Time).
- Serial Digital Command** A multi-function command where various bits within the word are assigned uses according to position. Some are "one-bit", one Discrete Command per state bits, while other bits may be grouped, for example, as sets of ordered pairs for more complex Commands (see Commands).
- Set** A Test Directive, entered from the CRT keyboard, followed by either a segment name or a Test Time. Subsequent run time will increment from the start of specified segment, or from the start of the specified Test Time within the Segment under test (see Run & Hold).
- Simulation Output Listing** A detailed, time-ordered listing showing all vehicle commands (RTC and SPC) expected to be uplinked, all GSE commands, all data processing, test control, and command processing directives requested to be acted upon by the ground software, as well as the expected vehicle telemetry and GSE monitor responses (see Commands).
- Software Commands** Software Commands are RTCs or SPCs which directly affect software within the SSM computer (DF224). An example is a command which sets the DF224 time to a specified value (see Real-Time Commands and Stored Program Commands).
- Standard Configuration** A Standard Configuration exists for each subsystem. It is a high visibility mode with as many systems powered as restrictions allow to provide for detection of unwanted interaction between systems. This Standard Configuration is used as a starting point for any system or subsystem test and provides maximum flexibility to other points in the test procedure where the same Standard Configuration exists.
- Stored Program Commands** SSM Stored Program Commands (SPCs) are commands which are stored within the SSM computer with an associated Vehicle Time tag and issued as a function of Vehicle Time. The time tag may be either a relative (delta) or an absolute time tag. The on-board command software issues an SPC when the vehicle time equals, or exceeds by less than one second, the absolute time tag of a command. For relative SPCs, the execution time shall be the previous command issue time plus the delta time. SPCs which have the same time tag shall be issued every 25 milliseconds during the time tag specified second. They shall be issued in the order in which they were loaded, up to a maximum of 40 commands per second (see Commands and Vehicle Time).
- Test Procedure** An output of the simulation program used by the Test Conductor and other support personnel for computer controlled ST testing. In addition to being a "roadmap" showing all decision points where the Test Conductor's interaction is required, it also contains all manual instructions and functions (see Simulation Output Listing).

Test Segments	Test Segments are the basic building blocks of a subsystem test. Each segment is composed of one or more Test Sequences and is generally fifteen minutes to one hour in length. In a Test Procedure, the Test Segment is the smallest defined entity with each assigned its own unique name. Lastly, each segment begins and ends with the sub-system in its Standard Configuration (see Test Sequence and Standard Configuration).
Test Sequence	A logical listing of time-ordered commands used to cause a test specimen to produce a specific test result (see Commands and Test Segments).
Test-Time	A timing system base for indicating and controlling time position and data processing functions within a Test Sequence. Test-Time is independent of other timing system and may be held, released, and reset, forward or back (see Hold and Run).
Time Window	The time interval within which a predicted monitor response should occur.
Time of Year (TOY)	A timing system independent of other timing systems that measures day and time of day.
Transient Limit	A unique type of Limit Check used to detect quickly changing monitor data values. The routine indicates a failure when the data value change exceeds the threshold specified. This technique may be employed in addition to the normal Limit Check routine (see Limit Check and Performance Limit).
Unconditional Verifier	A monitor whose state is a direct effect of the execution of some Command, or set of commands (see Commands).
Vehicle Time	Absolute: This is the time indicated by the Vehicle Time word as seen on telemetry. Stored Program Commands uplinked with an absolute time label will execute when the Vehicle Time equals their absolute time specified in the uplinked word.  Delta: Stored Program Commands uplinked with a delta time will execute when the Vehicle Time has advanced from the previous SPC execution a time increment equal to the delta specified in the uplinked word (see Commands).

## 8.2 Power-On Test

The Power-On test will assure that all systems or subsystems are commanded to a minimum power state, conditioned, and then powered to the ON condition. The Power-On test will be designed to accept the ST in an unknown configuration. As each system is powered, monitor limit-checking will be instructed to verify that correct responses occur with no unplanned interactions between systems.

The ST Standard Configuration for each system or subsystem will exist at the completion of the Power-On sequence and will define the entry point for all subsequent testing. It is a high-visibility mode, with as many systems powered as restrictions allow, to allow detection of unwanted



interactions between systems. This Standard Configuration is used as a starting point for any system or subsystem test, and provides maximum flexibility to other points in the test procedure where the same standard ST configuration exists. Entry points will allow the T/C to run the Power-On sequence and then select any test sequence on the Control File. The T/C may perform the test segments in any desired order. Entry points will be used to facilitate the rerun of any subsystem test, either for special testing or for troubleshooting. Entry points may also be used to enter or exit at various points in a subsystems Functional test (ref. Figure 7-1, Representative Control File Structure). Entry points exist at each sequence completion and while in the Standard Configuration.

Capability shall exist to retain ST test configuration in the event of planned holds from the Control File, unplanned holds initiated by the T/C or due to fault detection. Test holds due to command rejects or constraint violation fall under the category of fault detection.

Capability shall exist to place the SI's in Safe Mode via a switch on the master control panel. This Safe Mode switch shall be independent of the VAX 11/780 computer system.

In the event of "A" or "B" side failure of DF224, the DF224 will place the ST in safe mode. An evaluation of the failure will be performed and resolved by appropriate personnel. The redundant side will be activated, loaded and verified, then DF224 activity will be reinitialized.

### **8.3 Functional Test**

A Functional test is a collection of test segments which check out both flight software and flight hardware systems or subsystems to the fullest extent possible, under the given test configuration. The test will be designed to obtain the data necessary to verify the test requirements as specified in the VRSD. All commands (DM-01) are exercised and all monitor (DM-02) responses verified in every state. Performance limits will verify not only those monitors specified as responding, but will also verify that there is no unwanted interaction between systems. Although a Functional test may consist of several test segments the beginning and end of each segment will return the ST to the standard entry point configuration. A Functional test may be designed to automatically verify performance of a subsystem, a combination of subsystems, or the total ST (ref. Figure 7-2, Typical Functional Test Segment Order). Functional testing will also include exercising the ST in a mission mode.

Some system or subsystem functions require manual operations. Such tests do not lend themselves to automated testing and will be performed during hold periods of the automated test. These manual operations may be grouped together in a segment where the Control File is used to configure the subsystem to a state where a hold is inserted and the manual function performed.

### **8.4 Confidence Tests**

A Confidence test is designed to assure that the system or subsystem hardware is operational and provides a high degree of confidence that no serious problems exist. A System Confidence test usually does not usually include manual operations. It is an automated test which exercises commands (but only those command sequences considered necessary) and monitors (although not necessarily all monitor levels). A confidence test is typically run first on a system or subsystem before a commitment is made to run lengthy system or subsystem function tests. Confidence tests may also be used to verify the post-transportation condition of the ST at all test locations and for quick retests whenever a component is replaced or a connector has been demated or mated. A Confidence test will be designed for each SSM subsystem, the OTA, SA, SI C&DH and each SI.

## 8.5 Environmental Tests

Functional and Confidence tests will be utilized during all phases of the verification program including Pre-Acoustic, Post-Acoustic and Thermal Vacuum (TV) testing. A Functional test segment which cannot be performed under test environmental conditions due to hardware constraints or lack of GSE will be identified by entry points. Entry points enable these portions of the test to be bypassed. For example, a unique test segment may also be inserted to check heater operation under low temperature conditions, as required.

## 8.6 Health And Status Checks

The term "Health and Status" (H&S) as described in this document refers to a special power and command configuration used on the ST. The H&S configuration will be used to verify the ST condition during extended "power on" periods where no confidence or functional tests are planned. The ST shall be in a known or standard power and command configuration prior to the initiation of a H&S check. A typical "known or standard" configuration is summarized in Figure 7-3.

The function of the H&S checks shall be to ensure that critical hardware or critical support hardware is operated within specified limits and that the vehicle remains electrically static. A health check shall include only those commands necessary to turn selected hardware on and off.

## 8.7 Special Tests

Special tests are unique test sequences that do not fall within any previously defined category.

Special test sequences will normally be performed only one time during a test cycle and include test sequences where simulators are substituted for flight hardware.

Special tests will include but will not be limited to:

- EMC
- ST Mission Simulation
- STOCC Interface Compatibility
- Acoustic
- Thermal Vacuum
  - Pumpdown
  - Power-On Soak
  - Corona-Region Transition
  - Tape Recorder Spooling During Temperature Transition
- Preplanned "Macro" used for system-level problem isolation prior to entering a troubleshooting mode (during real-time test)
- Sequence designed and preplanned to enter "Safemode" from a known configuration

- Sequence to recover from "Safemode," both preplanned and unplanned
- Sequences entered during "Real-Time" operation via T/C CRT for troubleshooting activity and unplanned out-of-scope activity
- Sequences where it is not practical to have all flight equipment on board and the interface is simulated by SIVS or other means to evaluate command and/or monitor response
- System shutdown is the predetermined normal shutdown sequence entered by the test conductor during real-time operation via the T/C CRT for power off. Emergency shutdown is provided by the GSE.

## **8.8 Science Data Processing**

The Spacecraft Automated Test System (SATS) equipment and software will accomplish science data memory load, dump, and verification via the SATS VAX 11/780 computer system using its single front-end processor. Wideband tape recording capability for the telemetry data will be available.

## **8.9 Real-time Software**

The real-time verification software programs (TRVP and TRFP) provide test control, data compression and analysis for all ST and GSE/STE commands and monitors, including load, dump, and verification of memory in accordance with the TP.

## **8.10 Test Control**

Automated test control is provided from the Control File for all ST and GSE/STE command. The T/C directs the test through the use of console entries (such as run, pause, hold or desired time or segment selection). The T/C may also modify the test by sending both ST and GSE/STE commands or loading ST commands during the test holds. Monitor data processing instructions may also be modified in real time while the test is in process during both run and hold (ref. Figure 8-5, Typical CRT Input Statements to the Real-time Program).

When no hardware or software problems arise, the test will follow the preplanned TPs with a minimum of T/C intervention. Progression from one system or subsystem test to the next requires the T/C to select the next test segment to be performed. In the event of an alarm limit failure, special procedures may be initiated to correct or investigate the condition.

Only those monitors and conditions requiring immediate T/C attention will be "alarmed". All actions in response to an alarm limit failure will be initiated by the T/C. There is no "automatic segment stop" capability designed into the SATS ground test software which responds to an alarm limit failure. There will be, however, preplanned "holds" designed into the test segments to perform necessary manual tasks (i.e., test configuration changes) in support of the test objectives. Some alarm limit failures may be cause only to hold the test for evaluation, while others may require the immediate initiation of a preplanned contingency segment on the Control File or manual intervention. All master control console entries, including ST and GSE/STE commands, will be printed as T/C entries on the real-time printer.

The SATS ground test software has the capability of repeating portions or entire test segments as many times as necessary. Normally, test time will be cycled to a standard entry point (ref. para. 7.1) in a given test segment where the initialization commands will configure the SSM/ST

equipment for the test. Very long subsystem or system functionals may contain several entry points to aid in the convenience of retest or troubleshooting activities. If a standard entry point does not exist at a convenient place in the test segment, then the T/C has the option of selecting any time in the segment to "enter the run". Preselected "HOLD" points may be inserted as required. Such action is predicated on the assessment of the hardware configuration to ensure that it is safe to do so.

The capability will exist for SSM, SI, SI C&DH computer and microprocessor memory load, dump and verification via the SATS computer system. There will also be a capability for wideband recording and playback to the VAPGS of the science data TLM for post test analysis.

## 8.11 Data Compression

Data compression will be accomplished on each monitor using a floating aperture which specifies the minimum deviation from the last data output value which will result in the generation of a new output value. The floating aperture will be used as the first step in any data processing for a given monitor.

## 8.12 Data Analysis

Verification of monitor response to commands will be performed in real time by software program (TRTP) limit checking. If all telemetry and GSE/STE responses to commands remain within specified limits, indicating that monitor response was as predicted, then no printer output will occur. Responses not following within limits will be printed as a data limit failure (ref. Figure 8-6, Typical Line Printer Output - Column Mode and Figure 8-7, Typical Line Printer Output - Line Mode). CRTs will also be available as a real-time method for presentation of data.

Normal configuration of the CRT terminal is a dark screen with characters that appear lit. The "reverse video" configuration is a light background with dark characters. The configuration of the CRT can be altered by software. In addition, there are other features of the CRT which can be invoked by software on any character or range of characters. These features include, but are not limited to, standard configuration, reverse video, bright reverse video (the reverse video background has a higher intensity), and blinking (alternating between standard configuration and either of the two reverse video configurations).

If a monitor is not being limit checked, the short form of the measurement number will have a reverse video background. If a monitor passes data because of a data compression aperture exceedence, then a flag indicating this may appear.

If a monitor fails limits, then the special video capabilities of the CRT may be invoked, depending on which particular CRT page is being viewed. Since the screen line is limited to 80 characters, only a certain amount of space is available for the information that is needed by the CRT users. The measurement name takes 20 characters. The monitor value and engineering units take 13 characters. The measurement number short form takes 4 characters. This leaves 3 characters for a flag and two spaces to give the page some clarity between fields. Examples of CRT displays as printed out are shown in Figures 8-8 through 8-12.

In addition, a limited number of monitors will be presented on strip chart recorders in real time.

The software limit check capability frees the test data team (TDT) for the evaluation of a smaller number of contingency situations and investigation of the cause of monitor exceptions to the predicted limits. If all telemetry and GSE/STE monitor responses to commands have been properly predicted, no out-of-limits printer output will occur. A performance limit failure will not

cause a test hold unless the TDT requests manual T/C intervention. Each limit failure will be analyzed to determine if there is a hardware problem. If no hardware problem exists and other exceptions to the limit checking routine require definition, the analysis effort will be redirected. The TDT must necessarily include individuals familiar with the test procedures, test data and the hardware under test. Monitor data processing instructions (such as performance limits) may be modified as a result of the analysis. Hardware anomalies may exhibit failure forms other than those which normal limit checking routines can detect. Causes or isolation of such anomalies can usually be determined by a trained data analyst during review of records, data sorts and plots.

Data discrepancies (DD) will be issued to document all exceptions to the limit checking routine unless specific comments routed to the printer indicate a preplanned limit deviation.

**EXAMPLE**

## **9.0 SUPPORT EQUIPMENT**

This section of the ST Assembly and Verification (A&V) Plan describes the support equipment required at the Space Telescope Assembly and Verification Facility (STAVF) and the launch site. It specifically identifies Ground Support Equipment (GSE) and Special Test Equipment (STE) required for assembly, verification and handling of the ST, Space Support Equipment (SSE) for the initial ST deployment mission, government furnished equipment (GFE) from Associate Contractors, Goddard Space Flight Center (GSFC), and Kennedy Space Center (KSC), support equipment verification requirements, and logistics of support equipment maintenance, transportation and storage. The specifics of GSE/STE design and validation are contained in the GSE/STE requirements specification (see references).

All Associate Contractor handling equipment is to arrive at LMSC certified and proof loaded.

### **9.1 SSM/ST Contractor GSE/STE**

#### **9.1.1 SSM/ST Contractor Electrical GSE/STE**

The SSM/ST contractor electrical GSE/STE includes that system's electrical/electronic equipment and the ancillary electrical equipment which will be required to perform ST verification. Complete definition of this equipment is in the GSE/STE requirements specifications. Figures 9-1 and 9-2 summarize the utilization of this electrical GSE/STE at the STAVF and GSE at the launch site as used in conjunction with CTV support.

GSE/STE electrical/electronic hardware, when combined with the operating software, data base, and test files (sequence of commands and limits to perform the tests) comprise the Spacecraft Automated Test System (SATS). This system is designed to allow testing of the SSM and ST under the control of a preprogrammed sequence of events, with a predetermined set of responses, through the use of a computer controlled test complex.

### **9.3 Multi-use Mission Support Equipment (MMSE)**

Several major pieces of support equipment are available to all payloads launched from KSC to meet user requirements for payload transportation, environmental control, interface verification testing, end-to-end functional testing and installation of the payload into the orbiter. The ST program will be utilizing those items of MMSE identified below and shown in Figure 9-11.

#### **9.3.1 Payload Canister**

The payload canister is a container used to transport payloads from processing facilities to the location where ST installation into the orbiter will be performed. This equipment approximates the orbiter cargo bay in terms of size, mechanical interface, door configuration and cleanliness, and can be transported in either the horizontal or vertical attitude.

The canister will be utilized to transport the ST in the vertical attitude from the VPF to the launch pad for installation into the payload ground handling mechanism (PGHM) of the rotating service structure (RSS). Proper installation of the ST in the canister sill-mounted payload retention mechanisms will constitute another step in assuring that the ST will mate with the orbiter.

### **9.3.2 Canister Transporter**

The transporter is a flatbed vehicle, 18 ft. wide and 65 ft. long, which will be utilized to move the canister between KSC facilities. The unit has canister checking provisions, steerable wheels, self-contained braking and stabilization jacking provisions and a suspension system to minimize over-the-road shock and vibrations. An internal combustion engine driven prime mover will be used to move the transporter along RSC roads. Self-contained electric motors will be used to move the transporter within KSC cleanliness controlled facilities. The transporter will be utilized on the ST program to move the loaded canister from the VPF to the launch pad in the vertical attitude.

### **9.3.3 Transporter Instrumentation Set**

The transporter instrumentation set will monitor and record accelerations, hydrocarbons, particle counts, temperature and humidity experienced by a payload in the canister during transit. The set is self-contained and includes a power supply, transducers, signal conditioning equipment, and interface cabling.

### **9.3.4 Environmental Conditioning Unit**

This unit will provide conditioned air to maintain the ST within the 65 degree F. to 75 degree F. and 30-50 percent relative humidity environment. The conditioned air will be guaranteed Class 5000 (HEPA filtered, with less than 15 PPM of hydrocarbons). This unit will also have a dual electrical power generating system. Controls, alarms, recording, and monitoring will also be included.

## **9.4 Logistics**

Logistics for GSE and SSE will be accomplished as described in LS-01 Logistics Plan. Logistics for GFE is described in GFE Management Plan, LS-03. Encompassed in these documents are spares and inventory management, transportation and packaging, verification and training. They describe systems used successfully to support a multitude of past space vehicle and payload programs.

## **9.5 TDRSS/NASCOM Support**

The SSM/ST will be capable of receiving multiple-access (MA) signals from the tracking and data relay satellite system (TDRSS) forward link and transmitting both MA and SSA signals to the TDRSS return link when utilizing the NASA CTV at STAVF and the mila relay at KSC. Tracking and cross-support capability will be provided by the ST. Cross-support capability will include provisions to receive SSA signals at MA frequencies in order to handle the maximum required command -rate. Two selectable command rates will be received by the ST via the MA forward link or SSA cross-support, and science and engineering data will be transmitted via the MA and/or SSA return links. ST to GSTDN compatibility testing will be performed using TDRSS.

The TDRSS will provide telecommunication services which will relay communication signals between the ST and the ground. A real-time bent pipe concept is utilized in the operation of the TDRSS telecommunication service. It will be capable of transmitting and receiving ST data, and tracking the ST over at least 85 percent of the orbit. Communications between the ST and the TDRSS will be performed only on S-BAND within the frequency ranges and geographical coverage as defined in the TDRSS User's Guide, STDN 101.2.

NASCOM is the terrestrial telecommunication system implemented by NASA to connect the TDRSS ground terminal to ground located users and consists of leased data communication services. These services will be provided to the STOCC for all forward and return link data. The NASCOM will also provide communications between the STOCC and the STAVF and between the STOCC and the launch site. These services will be scheduled with the Network Control Center (NCC) through the STOCC. STOCC support should include but not be limited to:

- Test requiring STOCC support
- Duration of STOCC monitoring and commanding
- Data link requirements
- Plans for test execution and data evaluation

## 9.6 Space Support Equipment (SSE)

LMSC will supply SSE for the deployment mission only (ref. LMSC 4174620, Space Support Equipment Requirement Specification for ST). This SSE consists of those hardware items that are mounted, stowed on-board the ST's orbiter, and are required to provide mission support for ST during a deployment mission including launch, ascent, deployment, unscheduled maintenance, retrieval, stowing, and unscheduled return to earth:

- Deployment umbilical cable and disconnect mechanism
- Deployment umbilical mounting bracket
- Interface power control unit
- Foot restraint
- Portable handles
- Tools and aids
- SSE stowage
- Crew compartment controls and displays

## 9.7 Support Equipment Verification

### GENERAL:

Verification methods to be used to demonstrate that the GSE specified herein satisfies requirements shall be any or all of the following (ref. GSE/STE Requirements Specification)

#### Inspection:

Quality Control at the manufacturing level is the basis for verification of quality, and acceptance is based on verification that the item, as fabricated and assembled, conforms to the drawing.

#### Proof Testing:

Appropriate mechanical GSE assemblies for all configurations of equipment use shall be load tested before first usage with program hardware by application of accurately simulated loads at least 200 percent of design limit loads. Requirements shall be as specified on the appropriate GSE drawing.

#### Functional Testing:

Upon completion of proof testing, appropriate items of mechanical GSE shall be tested to verify interface compatibility, operating clearances, ability to accomplish the intended



functions, and as specified on the applicable drawing. The equipment shall be tested in the modes of planned operations using a simulator where specified on the applicable drawing. This simulator will duplicate the handling equipment interfaces and provide an envelope of the appropriate SSM/ST sections.

Electrical GSE shall be tested to the requirements of the appropriate equipment test procedure (ETP), which shall verify the full capability of the unit under test. Simulation of all interfaces shall be provided via GSE/STE, or LMSC-supplied test aids.

**EXAMPLE**

## 10.0 FACILITIES

The facilities for the SSM Assembly and Verification (A&V) and the ST A&V at the Space Telescope Assembly and Verification Facility (STAVF) in Sunnyvale, California are described here. Contamination requirements are discussed in PA-02, ST Contamination Control Plan.

### 10.1 STAVF

The STAVF is the collective name given to those ST integration contractor facilities located in Sunnyvale, California, for use in SSM/ST A&V. The major elements are the Vertical Assembly and Test Area (VATA), the Associate Contractor Receiving and Inspection (R&I) Depot, the Acoustic Test Cell and the Thermal Vacuum (TV) chamber. These elements are described in the following paragraphs, and their relative locations are shown in Figure 10-1.

#### 10.1.1 VATA

This is a new facility, shown in Figure 10-1, to support the Vertical Assembly Test Stand (VATS) to be used as illustrated in Figures 10-2 and 10-3. ST ambient operations at the STAVF will be accomplished in the VATA High Bay that has a Class 10,000 horizontal laminar flow tunnel, temperature range of 65 degrees F. to 80 degrees F., and a relative humidity of 30 to 50 percent.

The VATA has a master junction box that controls the distribution of RF and digital data and command information between the ST and the SATS. This junction box can be configured to support ST verification activities in the VATA, Acoustic Cell, and the Thermal Vacuum chamber by manually switching the cable runs to the appropriate test station. Each of the test station interfaces will be validated during the initial SATS complex checkout and again just prior to the actual verification activities.

A structure adjacent to the high bay has the following features:

- Change Room and Air Shower for personnel entry into the
- Clean Room
- Desk and board space for on-site VATA support personnel
- Status Room
- Office and data analysis areas for all Associated
- Contractors

The planned layout of the VATA is shown in Figures 10-4 and 10-5.

An intra-facility communication system will be available in the VATA for use by contractors which will include 12 stations in the TCC Room, 2 on each level of the VATS, and 4 other stations on the VATA floor.

#### 10.1.2 SI Receiving And Inspection (R&I) Depot

R&I and off-line operations associated with the optical telescope assembly (OTA) and the solar arrays (SA) will be performed in the VATA high bay. R&I of the scientific instruments (SI's) and the SI control and data handling (SI C&DH) subsystem will be performed in a separate depot (see Figure 10-6). The R&I Depot was designed to meet a Class 300,000 Clean Room requirement and will be controlled similar to VATA. Entry will be via the Change Room. There will be two Class 10,000 laminar flow tunnels. The depot will be maintained at 65-80 degrees F. and a relative humidity of 30-50 percent. This depot will be located in building 156F.

### 10.1.3 Acoustic Test Cell

The test cell to be used for ST acoustic testing is 44 feet wide x 50 feet long x 86 feet high (approximately 200,000 cubic feet). A direct field of 163 dB and/or a reverberant field of 156 dB can be generated on a large diameter (up to 22 feet) vehicle. A nitrogen gas supply powers the 16 electro-pneumatic noise generators in the facility. The cell contains a 20-ton crane with a hook height of 74.5 feet.

The acoustic control and data acquisition system performs the major functions of acoustic environment control and-monitoring. The system is a hybrid, using both analog and digital techniques to perform its various functions, and is composed of two major elements: the noise generation and the data acquisition subsystems. These - subsystems use a Digital Equipment Corporation Model PDP-9 computer with the following peripheral equipment:

- Random Access drum storage with a 131,000 word memory
- Computer memory of 15,000 words
- Digital magnetic tape storage
- Paper magnetic tape storage
- Keyboard printer

### 10.1.4 Thermal Vacuum (TV) Chamber

The chamber to be used for TV testing of the complete ST is a horizontal chamber located in a Clean Room. This chamber has an overall internal length of 75 feet and an internal diameter of 24 feet.

The chamber is constructed of 304 austenitic stainless steel, with a polished interior, and supported by mild steel stiffeners. A liquid nitrogen shroud surrounds the specimen and is able to provide a 100 deg. R environment. An infrared heat flux simulator with 76 zones, controlled by a Varian 6201 computer, provides orbit temperature simulation.

The chamber can simulate a pressure altitude of 200 miles and achieve this condition in 12 hours. The pumping system includes four Tandem roots-type roughing pumps which lower the chamber pressure -to approximately 100 microns. A 20 degree K helium cryogenic pump then solidifies all the remaining gas materials (with the exception of HE, H<sub>2</sub>, and N<sub>2</sub>) on a shroud. These remaining gases are collected by an ion pump and a titanium sublimation pump.

Supplemental thermal instrumentation is monitored on a computer controlled data acquisition system. This system, in conjunction with the infrared heat flux system, automatically controls the temperature environment in the chamber. Up to 1000 channels of thermocouple data are recorded by magnetic tape for processing. The chamber is equipped with a 16 channel real-time analog plotter and a digital printer.

### 10.1.5 Staging Area

An area is provided outside the VATA in B/156C within the ST loading area, Figure 10-7, to be used for the unpacking, cleaning, staging, and assembly of GSE and other ST equipment prior to transportation into VATA and the R&I Depot. There will be a curtain from ceiling to floor sectioning off this area just outside the VATA B/156C door to maintain a higher degree of cleanliness than exists in the ST loading area.

## **2.3**

# **VERIFICATION REQUIREMENTS AND SPECIFICATIONS DOCUMENT**

### **2.3.1 INTRODUCTION**

The Verification Requirements and Specifications Document (VRSD) defines the detailed requirements and specifications for the verification of flight hardware and software. The VRSD examples provide two different formats for presenting the verification requirements and specifications. Example 1, the Verifications Requirements and Specifications Document for the Solar X-Ray Imager (SXI) Program, provides effectivity columns to indicate the verification site(s) where the requirement is to be verified. Example 2, part of one of the Verification and Requirements Specifications Document of the Hubble Space Telescope Program, provides visibility as to the detail the verification requirements are defined for a large payload program. Example 2 does not contain effectivity designations as one or more VRSD's are required for each verification site. Example 1 was prepared by Science and Engineering of MSFC's Systems Analysis and Integration Laboratory and Example 2 was prepared by the Lockheed Missiles and Space Company, Space Systems Division, for the Hubble Space Telescope Program.

**2.3.2**

**VERIFICATION REQUIREMENTS AND  
SPECIFICATIONS DOCUMENT**

**EXAMPLE 1**

**THIS PAGE INTENTIONALLY LEFT BLANK**

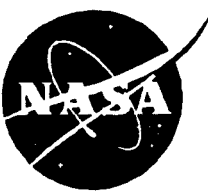

National Aeronautics and  
Space Administration

MSFC-HDBK-2221  
February 1994

---

George C Marshall Space Flight Center  
Marshall Space Flight Center, Alabama 35812

**SOLAR X-RAY IMAGER  
VERIFICATION REQUIREMENTS AND  
SPECIFICATIONS DOCUMENT**

**EXAMPLE**



**EXAMPLE**

THIS PAGE INTENTIONALLY LEFT BLANK

TABLE OF CONTENTS

<u>SECTION</u>	<u>PAGE</u>
LIST OF FIGURES .....	2.3-11
LIST OF APPENDICES .....	2.3-12
LIST OF ACRONYMS.....	2.3-13
1.0 INTRODUCTION .....	2.3-14
1.1 Purpose.....	2.3-14
1.2 Scope .....	2.3-14
1.3 Documents .....	2.3-14
2.0 SYSTEM DESCRIPTION .....	2.3-16
3.0 GROUND RULES AND REQUIREMENTS .....	2.3-16
3.1 Ground Rules.....	2.3-16
3.2 Retest Requirements .....	2.3-17
4.0 FORMAT.....	2.3-18
4.1 Number.....	2.3-18
4.2 Description.....	2.3-18
4.3 Measurement Stimuli.....	2.3-18
4.4 Specifications .....	2.3-18
4.5 Remarks and Constraints.....	2.3-18
4.6 Effectivity .....	2.3-19

**PART I  
VERIFICATION REQUIREMENTS AND SPECIFICATIONS  
SXI FLIGHT HARDWARE**

1.0 TESTS.....	2.3-21
1.1 FUNCTIONAL TESTS .....	2.3-21

1.1.1	Data Electronics Box.....	2.3-21
1.1.2	SXI Interface .....	2.3-22
1.1.3	Power Electronics Box .....	2.3-23
1.1.4	High Voltage Power Supply.....	2.3-24
1.1.5	Data Management System.....	2.3-25
1.1.6	Power Draw .....	2.3-25
1.1.7	Alignment.....	2.3-26
1.1.8	Grounding/Bonding/Isolation .....	2.3-27
1.1.9	Mass Properties .....	2.3-28
1.1.10	Filter Wheel.....	2.3-28
1.1.11	Vacuum Door Assembly .....	2.3-29
1.1.12	Telescope.....	2.3-29
1.1.13	Thermal.....	2.3-30
1.2	ENVIRONMENTAL TESTS.....	2.3-31
1.2.1	Sinusoidal Vibration Test.....	2.3-31
1.2.2	Sine Diagnostic (Sweep) Test .....	2.3-31
1.2.3	Random Vibration Test.....	2.3-32
1.2.4	Shock Test.....	2.3-32
1.2.5	Acoustic Test .....	2.3-33
1.2.6	Thermal Vacuum Test .....	2.3-33
1.2.7	Thermal Balance Test.....	2.3-34
1.2.8	EMC Test .....	2.3-34
1.2.8.1	Radiated Emissions Test.....	2.3-34
1.2.8.2	Radiated Susceptibility Test .....	2.3-35
1.2.8.3	Conducted Emissions Test .....	2.3-35
1.2.8.4	Conducted Susceptibility Test.....	2.3-37
1.2.9	Outgassing/Offgassing Test.....	2.3-39

1.2.10	Ascent Pressure Test.....	2.3-39
2.0	ANALYSES .....	2.3-39
2.1	Structural .....	2.3-40
2.2	Dynamic .....	2.3-41
2.3	Thermal.....	2.3-42
2.4	Materials.....	2.3-43
2.5	Venting .....	2.3-45
2.6	Mass Properties.....	2.3-45
2.7	Humidity .....	2.3-45
2.8	Pressure .....	2.3-46
2.9	Power.....	2.3-46
2.10	Life.....	2.3-47
2.11	Magnetic.....	2.3-47
2.12	Radiation .....	2.3-48
2.13	Loads .....	2.3-48
2.14	Micrometeoroid.....	2.3-49
2.15	Electrical.....	2.3-49
2.16	Pointing.....	2.3-50
3.0	DEMONSTRATION.....	2.3-51
3.1	Mounting .....	2.3-51
3.2	Filter Changeout.....	2.3-52
3.3	Cable Connect/Disconnect.....	2.3-52
4.0	INSPECTION .....	2.3-52
4.1	Envelope.....	2.3-52
4.2	SXI Interface.....	2.3-53
4.3	Assembly.....	2.3-54

**EXAMPLE**

4.4	Data Format .....	2.3-54
4.5	Design & Construction .....	2.3-55
4.6	Safety & Mission Assurance.....	2.3-57
4.7	Contamination .....	2.3-58

**PART II  
VERIFICATION REQUIREMENTS AND SPECIFICATIONS  
SUPPORT EQUIPMENT**

1.0	GROUND SUPPORT EQUIPMENT .....	2.3-60
1.1	Mechanical Ground Support Equipment (MGSE).....	2.3-60
1.2	Electrical Ground Support Equipment (EGSE).....	2.3-60
1.3	Transportation & Shipping.....	2.3-62

**EXAMPLE**

LIST OF FIGURES

FIGURE

PAGE

1 SXI Configuration.....2.3-17

**EXAMPLE**

LIST OF APPENDICES

<u>APPENDIX</u>		<u>PAGE</u>
I	Sinusoidal Vibration Test Accelerometer Locations .....	NA
II	Sine Diagnostic (Sweep) Test Accelerometer Locations .....	NA
III	Random Vibration Test Accelerometer Locations .....	NA
IV	Shock Test Accelerometer Locations .....	NA
V	Acoustic Test Sensor/Accelerometer Locations .....	NA
VI	Thermal Vacuum Test Thermocouple Locations .....	NA
VII	Thermal Vacuum Test Profile Data .....	NA
VIII	Thermal Balance Test Thermocouple Locations .....	NA
IX	Thermal Balance Test Profile Data .....	NA
X	Ascent Pressure Profile Data .....	NA

**EXAMPLE**

LIST OF ACRONYMS

CDR	Critical Design Review
CEI	Configuration End Item
CG	Center of Gravity
DOC	Document
DR	Discrepancy Report
EGSE	Electrical Ground Support Equipment
EM	Engineering Model
EMC	Electromagnetic Compatibility
GSE	Ground Support Equipment
GOES	Geostationary Operational Environmental Satellite
HDBK	Handbook
IRD	Interface Requirements Document
MGSE	Mechanical Ground Support Equipment
MIL	Military
MIUL	Material Identification and Usage List
MOI	Moment of Inertia
MSFC	Marshall Space Flight Center
MUA	Material Usage Agreement
NASA	National Aeronautics and Space Administration
NOAA	National Oceanic and Atmospheric Administration
PDR	Preliminary Design Review
RD	Requirements Document
RQMT	Requirement
SAIL	Systems Analysis and Integration Laboratory
SPEC	Specification
STD	Standard
SXI	Solar X-ray Image
TBD	To Be Determined
TRR	Test Readiness Review
UV	Ultraviolet
VRM	Verification Requirements Matrix
VRSD	Verification Requirements and Specifications Document



1.0 INTRODUCTION

1.1 Purpose

The purpose of this document is to establish the subsystem/system level verification requirements for the Marshall Space Flight Center's (MSFC) developed Solar X-ray Imager (SXI) flight hardware and support equipment.

1.2 Scope

This document contains the detailed verification requirements for the verification activities outlined in the SXI Verification Plan, MSFC-PLAN-2236, for the SXI flight hardware and support equipment. This document does not contain the detailed verification requirements for component level items. Component requirements are established and verified within the design disciplines prior to installation into the subsystem/system level flight hardware. The document will address the requirements from which the verification procedures will be written.

Part I of this document contains the detailed subsystem/system level verification requirements to be levied on the SXI flight hardware and locations where the requirements will be verified.

Part II of this document contains the detailed verification requirements to be levied on the support equipment and locations where the requirements will be verified

1.3 Documents

The following documents form a part of this document to the extent specified herein or are listed as reference documents used in the development of this document.

1. MSFC-SPEC-2092, Solar X-Ray Imager Configuration End Item Specification (CEI)
2. MSFC-PLAN-2236, Solar X-Ray Imager Verification Plan
3. MSFC-HDBK-2221, Verification Handbook, Volume 1: Verification Process
4. MSFC-HDBK-670, General Environmental Test Guidelines (GETG) for Protoflight Instruments and Experiments
5. MSFC-HDBK-505A, Structural Strength Program Requirements
6. JSC-SP-R-0022, General Specification, Vacuum Stability Requirements of Polymeric Material for Spacecraft Application
7. NHB8060.1, Flammability, Outgassing and Odor Requirements and Test Procedures for Materials for Environments that Support Combustion
8. MSFC-HDBK-527, Materials Selection List for Space Hardware Systems
9. MSFC-SPEC-522, Design Criteria for Controlling Stress Corrosion and Cracking

10. MSFC-STD-531, High Voltage Design Criteria
11. NHB5300.4(1D-2), Safety, Reliability, Maintainability and Quality Provisions for the Space Shuttle Program
12. MMI 5300.12, MSFC Part and Material Traceability
13. MSFC-STD-383, Rubber Stamping of Electrical Equipment and Components
14. MIL-STD-130, Identification Marking of U.S. Military Property
15. MIL-STD-129, Marking for Shipment and Storage
16. MSFC-PLAN-2242, Solar X-Ray Imager Contamination Control Plan
17. SJ-E007077, Interface Requirement Document for Solar X-Ray Imager
18. MSFC-STD-1249, Standard NDE Guidelines and Requirements for Fracture Control Programs
19. MSFC-STD-397, Radiographic Laboratory Qualification
20. MSFC-SPEC-250A, General Specification for Protective Finishes for Space Vehicles Structures and Associated Flight Equipment
21. MIL-B-7883B, Bracing of Steels, Copper Alloys, Nickel Alloys, Aluminum and Aluminum Alloys
22. MIL-HDBK-5B, Metallic Materials and Elements for Aerospace Vehicle Structures
23. MIL-HDBK-17B, Military Handbook, Polymer Matrix Composites
24. MSFC-STD-506, Materials and Processes Control
25. MSFC-HDBK-527, Materials Selection List for Space Hardware Systems
26. X-601-84-2, The Space Radiation Environment for GOES Missions
27. MSFC-SPEC-1493, Electostatic Discharge Control Requirements
28. MSFC-PLAN-2252, Integration and Assembly Plan for the Solar X-Ray Imager
29. CCSDS 102.0-B-2, CCSDS Standards - Packet Telemetry Blue Book
30. NHB5300.4(3G), Requirements for Interconnecting Calbes, Harnesses, and Wiring
31. MSFC-STD-486A, Torque Limits for Threaded Fasteners

32. MSFC-STD-557, Usage Criteria for Spacecraft Applications of 6A1-4V Titanium Alloy Threaded Fasteners
33. MIL-STD-1515A, Fastener Systems for Aerospace Applications
34. MSFC-SPEC-445, Adhexive Bonding, Process and Material Inspection
35. MSFC-PLAN-1975, Software Quality Assurance Plan for the Solar X-ray Imager
36. MSFC-PLAN-2241, Product Assurance Plan for the Solar X-ray Imager
37. MSFC-PROC-404B, Drying and Preservation, Cleanliness Level and Inspection Methods for Gases
38. NHB6000.1C, Requirements for Packaging, Handling, and Transportation for Aeronautical and Space System Equipment and Associated Equipment

## 2.0

### SYSTEM DESCRIPTION

The SXI instrument is a telescope designed to monitor the X-ray spectrum of the sun and transmit video images to earth in near real time. The instrument is designed to operate from a geo-synchronous orbit aboard a Geostationary Operational Environmental Satellite (GOES), a family of satellites being developed by Space Systems Loral (SS/L). The GOES will provide to the instrument the primary power, communications to earth, and pointing and roll reference information, while the SXI will provide the solar imaging, image processing and pitch/yaw alignment sensing.

The general operation of the SXI instrument is to focus solar X-rays using a grazing incidence mirror into a camera assembly that can electronically process the X-ray image into a visible image of the sun. The video image is then digitized and transmitted back to earth via the GOES telemetry.

The SXI instrument consists of a telescope, a data electronics box, a power electronics box and a High Accuracy Sun Sensor (HASS) electronics box as shown in Figure 1. The four separate packages for the SXI instrument is due to the envelope and design of the GOES solar array gimbal yoke where the SXI will be mounted.

## 3.0

### GROUND RULES AND REQUIREMENTS

### 3.1

#### Ground Rules

- \* Tests contained herein are not sequence critical, unless specifically noted.
- \* GSE acceptance will be completed prior to testing with flight hardware.
- \* Support equipment (i.e. power supplies) must be in certification and calibrated at the time of use.

- \* The insertion and measurement of signals at electrical connectors will be done only through simulators and breakout boxes to avoid damage to flight hardware.

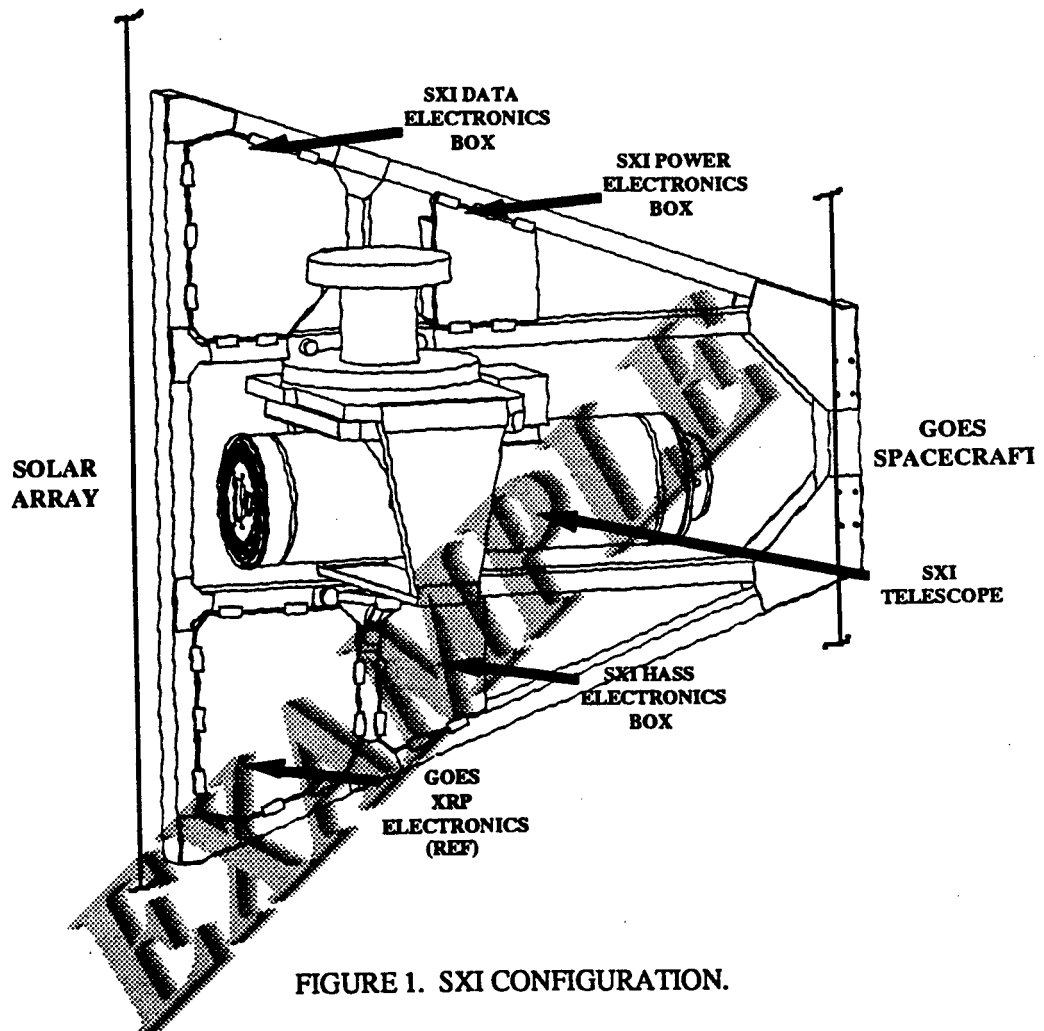

### 3.2 Retest Requirements

- \* A component or subsystem failure will invalidate any previous system level test and once the failure is repaired or replaced the discrepancy must be reviewed and dispositioned for retesting before the testing program can continue.
- \* A hardware design change to any component or subsystem invalidates any previous system level test and that component or subsystem or the entire system must be reverified to flight requirements, both functionally and environmentally.
- \* When a component is disconnected in the hardware, all functional paths to and through the connection will be tested after the reconnection is made.

- \* All software modifications shall be reverified prior to use with the flight hardware.
- \* Components removed for reasons other than failure (e.g. access) do not require bench testing prior to installation. However, all functional paths to and through the component shall be reverified after installation.

#### 4.0 FORMAT

Parts I and II of this document contains the detailed verification requirements in matrix form, including requirement statement, pass-fail criteria, constraints, and effectivity. A detailed description of each column is provided in subsequent paragraphs.

#### 4.1 Number

This column contains a numerical designation of the requirements.

#### 4.2 Requirement Statement

This column contains a descriptive statement of the requirement to be verified.

#### 4.3 Measurement/Stimuli

This column contains command or measurement numbers from the Instrumentation Program and Command List (IP&CL) to be used as verification.

#### 4.4 Criteria and Specifications

This column contains the "pass-fail" criteria necessary to satisfy the requirements. These values will reflect limits for all criteria where inaccuracies could be caused by the environment, Ground Support Equipment (GSE), or other factors.

#### 4.5 Remarks/Constraints

This column contains:

**REMARKS** - The remarks are explanatory information as required for clarification of the requirement.

**CONSTRAINTS** - (1) Any placards or limitations notes which must be verified prior to powering or operating a system or component.

(2) Any placards or limitations notes which must be adhered to during the performance or a requirement.

4.6

Effectivity

This column contains references to location(s) where the requirement is to be verified. Multiple effectivities may be used.

**EXAMPLE**

PART II  
VERIFICATION REQUIREMENTS AND SPECIFICATIONS  
SPACE FLIGHT HARDWARE

**EXAMPLE**

VERIFICATION REQUIREMENTS AND SPECIFICATIONS					EFFECTIVITY	
NUMBER	REQUIREMENT STATEMENT	MEAS / STIM	CRITERIA AND SPECIFICATIONS	REMARKS/ CONSTRAINTS	MSFC	LORAL
1	TESTS					
1.1	FUNCTIONAL TESTS					
1.1.1	Data Electronics Box					
1.1.1.1	Verify by test that the data electronics box's internal clock used for time tagging image data can be altered by ground command and meet the resolution criteria		Resolution of 1 second		X	
1.1.1.2	Verify by test that the data electronics box provides for selectable durations of an image exposure that meets criteria		From 1 ms to 8 seconds with a resolution of 1 ms		X	
1.1.1.3	Verify by test that the data electronics box's provided three bit status word used for safety/health monitoring provides information that meets criteria		Command error detected Internal error detected Imaging mode (yes/no)		X	
1.1.1.4	Verify by test that the data electronics box is capable of scanning the image data and produce the image statistical data that meets criteria		1) Number of saturated pixels 2) Number of pixels greater than or equal to 50% of full scale response		X	
1.1.1.5	Verify by test that the data electronics box is capable of capturing EUV flux data per criteria		An average rate of at least one set of EUV measurements per minute		X	

2.3 - 21



# VERIFICATION REQUIREMENTS AND SPECIFICATIONS

VERIFICATION REQUIREMENTS AND SPECIFICATIONS					EFFECTIVITY	
NUMBER	REQUIREMENT STATEMENT	MEAS / STIM	CRITERIA AND SPECIFICATIONS	REMARKS/ CONSTRAINTS	MSFC	LORAL
1.1.1.6	Verify by test that the data electronics box captures the HASS data per criteria		Captures data at both initiation and completion of the exposure and provides the data in the image telemetry data		X	
1.1.2	<b>SXI Interface</b>					
1.1.2.1	Verify by test that the SXI output data to the MDL transmitter meets criteria (3.2.3.6.1)		Paragraph 3.2.3.6.1, IRD SJ-E007077		X	
1.1.2.2	Verify by test that the SXI design meets the image availability criteria		Image integration and transmission of a single full-CCD image complete within one minute of command		X	
1.1.2.3	Verify by test that the analog telemetry signals from SXI meet criteria (3.2.3.4.1)		Paragraph 3.2.3.4.1, IRD SJ-E007077		X	
1.1.2.4	Verify by test that the bi-level type A telemetry signals from SXI meet criteria (3.2.3.4.2)		Paragraph 3.2.3.4.2, IRD SJ-E007077		X	
1.1.2.5	Verify by test the operation of SXI to the solar array status by providing inputs of the solar array step status that meets criteria (3.2.3.7.1)		Paragraph 3.2.3.7.1, IRD SJ-E007077		X	
1.1.2.6	Verify by test the operation of SXI to the XRP platform status by providing inputs of the X-ray positioner step status that meets criteria (3.2.3.7.2)		Paragraph 3.2.3.7.2, IRD SJ-E007077		X	

2.3 - 22

VERIFICATION REQUIREMENTS AND SPECIFICATIONS					EFFECTIVITY	
NUMBER	REQUIREMENT STATEMENT	MEAS / STIM	CRITERIA AND SPECIFICATIONS	REMARKS/ CONSTRAINTS	MSFC	LORAL
1.1.2.7	Verify by test the operation of SXI to the GOES latching relay commands by providing inputs of the command unit that meets criteria (3.2.3.5.1)		Paragraph 3.2.3.5.1, IRD SJ-E007077		X	
1.1.2.8	Verify by test the operation of SXI to the GOES proportional commands by providing inputs of the command unit that meets criteria (3.2.3.5.2)		Paragraph 3.2.3.5.2, IRD SJ-E007077		X	
1.1.2.9	Verify by test that the SXI/EUV Spectrometer Control Interface meets criteria		1) Four (4) digital control lines compatible with a 54AC04 driver. 2) Cycles over the counter range of 0000 to 1111 (binary) in synchronization with the SXI data frames		X	
1.1.2.10	Verify by test that the SXI/EUV Data Interface can read data and meets criteria		1) Single, two-line differential voltage 2) Maximum voltage on any one line is 10 VDC 3) Minimum voltage on any one line is -10 VDC		X	
1.1.2.11	Verify by test that the SXI provided power at the EUV interface meets criteria		1) Provides 20 V regulated power up to 25mA 2) Provides -20V regulated power up to 25mA		X	
1.1.3	Power Electronics Box					

# VERIFICATION REQUIREMENTS AND SPECIFICATIONS

VERIFICATION REQUIREMENTS AND SPECIFICATIONS					EFFECTIVITY	
NUMBER	REQUIREMENT STATEMENT	MEAS / STIM	CRITERIA AND SPECIFICATIONS	REMARKS/ CONSTRAINTS	MSFC	LORAL
1.1.3.1	Verify by test that the SXI Power Electronics Box supplies voltages that meet criteria		CEI Table 3.18-2		X	
1.1.3.2	Verify by test that the voltage regulation on the SXI Power Electronics Box supplied voltages meets criteria		+/- 200 mV for the 5V output +/- 500 mV for all other outputs		X	
1.1.3.3	Verify by test that the SXI Power Electronics Box supplied voltages meet the inrush current criteria		TBD		X	
1.1.4	<b>High Voltage Power Supply (HVPS)</b>					
1.1.4.1	Verify by test that the HVPS provides a 5000V programmable supply line to the FOT aluminized layer that meets criteria		1) 5000V full scale output 2) +/- 10V steady state accuracy 3) 10 microAmps of current 4) Programmable to 50V resolution		X	
1.1.4.2	Verify by test that the HVPS provides a programmable supply line to the MCP that meets criteria		1) 3.0 seconds/minute power nominal duty cycle 2) 1000V full scale output 3) Programmable to 4V resolution 4) 500 microseconds maximum transition time per image 5) 5V or less steady state ripple 6) 150 microAmps current		X	
1.1.4.3	Verify by test that the HVPS turn on sequence to the MCP meets criteria		5000V supplied prior to the application of the 1000V		X	

2.3 - 24

2.3 - 25

VERIFICATION REQUIREMENTS AND SPECIFICATIONS					EFFECTIVITY	
NUMBER	REQUIREMENT STATEMENT	MEAS / STIM	CRITERIA AND SPECIFICATIONS	REMARKS/ CONSTRAINTS	MSFC	LORAL
1.1.4.4	Verify by test that the HVPS supplied power to the UV lamp meets criteria		Start up voltage of 550 VDC with a sustained voltage of 120 VDC		X	
1.1.5	<b>Data Management System</b>					
1.1.5.1	Verify by test that SXI is capable of providing housekeeping and ancillary data to the ground which meets the data frequency criteria		At least once per minute when SXI is not transmitting images		X	
1.1.5.2	Verify by test that SXI data packets meet the time tagging resolution criteria		At least 1 millisecond		X	
1.1.5.3	Verify by test that SXI provides operational health data that meets criteria		1) input current over the operation power 2) temperatures of the mirror, detector, and electronics 3) error status 4) internal voltage references		X	
1.1.5.4	Verify by test that the data mangement subsystem meets the continuous data production criteria		Transmits filler data when a CCSDS packet is not ready for transmission		X	
1.1.5.5	Verify by test that the data stream transfer frame synchronization is maintained per criteria		Each CCSDS Transfer Frame will be preceded with the 32-bit synchronization marker		X	
1.1.6	<b>Power Draw</b>					

## VERIFICATION REQUIREMENTS AND SPECIFICATIONS

### EFFECTIVITY

NUMBER	REQUIREMENT STATEMENT	MEAS / STIM	CRITERIA AND SPECIFICATIONS	REMARKS/ CONSTRAINTS	EFFECTIVITY	
					MSFC	LORAL
1.1.6.1	Verify by test and supporting analysis that the SXI total power consumption, including the HASS and EUV, meets criteria		Less than 42 W average		X	
1.1.6.2	Verify by test that the SXI instrument will not be damaged nor will it draw any more power at the low bus voltage (3.2.3.1.2)		0.0 to 29.0 VDC		X	
1.1.6.3	Verify by test that the SXI instrument will operate over the GOES provided input power range (3.2.3.1, 3.2.3.1.1)		29.0 to 43.0 VDC	42.0 +/- 0.5 (Sunlight) 29.0 to 42.5 (Eclipse/Battery)	X	
1.1.7	<b>Alignment</b>					
1.1.7.1	Verify the alignment of the optical axis of the SXI Telescope to the SXI Telescope alignment reference (3.1.1.4.1)		Parallel to the normal of the alignment reference within 45 arc seconds and known to within 10 arc seconds		X	
1.1.7.2	Verify the alignment of the SXI Telescope to the HASS (3.1.1.4.4)		TBD		X	
1.1.7.3	Verify that the alignment of the optical axis to the focal plane detector meets criteria		Perpendicular to within 60 arc seconds		X	
1.1.7.4	Verify that the alignment of the optical axis to the plane defined by the mating surfaces on the interface pads of the mounting ring meets criteria		Perpendicular to within 1 arc-minute		X	

VERIFICATION REQUIREMENTS AND SPECIFICATIONS					EFFECTIVITY	
NUMBER	REQUIREMENT STATEMENT	MEAS / STIM	CRITERIA AND SPECIFICATIONS	REMARKS/ CONSTRAINTS	MSFC	LORAL
1.1.7.5	Verify that the SXI maintains the optical axis centered on the focal plane detector to meet criteria		Centered to within +/- 10 arc-sec		X	
1.1.7.6	Verify that the alignment of the lines of the CCD to the SXI telescope mounting plane meets criteria		Perpendicular to within 0.2 degrees		X	
1.1.7.7	Verify the alignment of the optical axis of the HASS to the optical axis of the telescope meets criteria		Within +/- 2.0 arc-min		X	
1.1.8	<b>Grounding/Bonding/Isolation</b>				X	
1.1.8.1	Verify by test the isolation from primary to secondary power return of the SXI DC/DC converters (3.2.3.8.1B)		Minimum 100k Ohms		X	
1.1.8.2	Verify by test the isolation between SXI primary power input leads and equipment case (3.2.3.8.1C)		Minimum 100k Ohms		X	
1.1.8.3	Verify by test the isolation between SXI signal and secondary power circuits from the primary power circuits and from the equipment case (3.2.3.8.1F)		Minimum 100k Ohms		X	
1.1.8.4	Verify by test that the SXI/spacecraft metal-to-metal bonding resistance meets criteria		Less than or equal to 2.5 m-Ohms		X	

2.3 - 27

VERIFICATION REQUIREMENTS AND SPECIFICATIONS					EFFECTIVITY	
NUMBER	REQUIREMENT STATEMENT	MEAS / STIM	CRITERIA AND SPECIFICATIONS	REMARKS/ CONSTRAINTS	MSFC	LORAL
1.1.8.5	Verify by test that the SXI/spacecraft metal-to-nonmetal bonding resistance meets criteria		Less than 1k Ohm		X	
1.1.8.6	Verify by test that the SXI MLI blanket-to-structure bonding resistance meets criteria		Less than 10 Ohm		X	
1.1.9	<b>Mass Properties</b>					
1.1.9.1	Verify by test and supporting analysis that the SXI Telescope's mass meets criteria		Less than or equal to 34.53 lb (15.66 kg)		X	
1.1.9.2	Verify by test and supporting analysis that the SXI Data Electronics Box's mass meets criteria		Less than or equal to 18.1818 lb (8.535 kg)		X	
1.1.9.3	Verify by test and supporting analysis that the SXI Power Electronics Box's mass meets criteria		Less than or equal to 13.137 lb (5.959 kg)		X	
1.1.9.4	Verify by test and supporting analysis that the SXI HASS Electronics Box's mass meets criteria		Less than or equal to 4.025 lb (1.826 kg)		X	
1.1.9.5	Verify by test and supporting analysis that the SXI's center of gravity (CG) meets criteria		X(cg) = -5.86 inches +/- TBD Y(cg) = 1.11 inches +/- TBD Z(cg) = 4.03 inches +/- TBD		X	
1.1.10	<b>Filter Wheel</b>					

# VERIFICATION REQUIREMENTS AND SPECIFICATIONS

NUMBER	REQUIREMENT STATEMENT	MEAS / STIM	CRITERIA AND SPECIFICATIONS	REMARKS/ CONSTRAINTS	EFFECTIVITY	
					MSFC	LORAL
1.1.10.1	Verify by test that the control electronics/stepper motor provides for filter wheel rotation that meets criteria		Bi-directional Rotation		X	
1.1.10.2	Verify by test that the control electronics provides for absolute knowledge of the final position of the filter wheel		Position of filter wheel agrees with that position controlled by the data subsystem		X	
1.1.10.3	Verify by test the ability of the data subsystem to implement the emergency torque mode of the filter wheel motor		TBD		X	
1.1.11	<b>Vacuum Door Assembly</b>					
1.1.11.1	Verify by test the operation of the door position sensor to determine if the vacuum door assembly is open or closed		TBD		X	
1.1.12	<b>Telescope</b>					
1.1.12.1	Verify by test that the instrument maintains the focal distance criteria		Maintained to +/- .001 inch		X	
1.1.12.2	Verify by test and inspection that calibration of the SXI instrument meets specification		MSFC-PLAN-TBD		X	
1.1.12.3	Verify by test and supporting analysis that the SXI image bandwidth meets criteria		6 to 60 Å (photon energy 2000/200eV)		X	

2.3 - 29



# VERIFICATION REQUIREMENTS AND SPECIFICATIONS

## EFFECTIVITY

NUMBER	REQUIREMENT STATEMENT	MEAS / STIM	CRITERIA AND SPECIFICATIONS	REMARKS/ CONSTRAINTS	MSFC	LORAL
1.1.12.4	Verify by test that the power provided to the HASS can be shutoff per criteria		HASS power is shutoff upon command from the data subsystem		X	
1.1.12.5	Verify by test that the camera assembly is capable of supporting integration times that meets criteria		1 ms to 4 ms		X	
1.1.12.6	Verify by test the filters when used in conjunction with the prefilters and the x-ray mirror select the applicable wavebands		1) TBD - 6-60Å 2) Beryllium, 12.7 micron - 6-20Å 3) Beryllium, 25.4 micron - 6-16Å 4) Beryllium, 50.8 micron - 6-12Å 5) Stainless Steel, 200 micron - 0Å 6) Open 7) UHV Quartz/Sapphire - >1500		X	
1.1.12.7	Verify by test and supporting analysis that the SXI spectral sensitivity meets criteria using an integration time of 100ms or less		1) Spectral Band: 6 - 20 Å Source: A 8.3 Å Min Detectable Flux (ergs cm <sup>-2</sup> arcsec <sup>-2</sup> sec <sup>-1</sup> ): 1.5 x 10 <sup>-8</sup> 2) Spectral Band: 6 - 60 Å Source: C 44 Å Min Detectable Flux (ergs cm <sup>-2</sup> arcsec <sup>-2</sup> sec <sup>-1</sup> ): 6 x 10 <sup>-8</sup>		X	
1.1.13	<b>Thermal</b>					
1.1.13.1	Verify by test the operation of the four SXI temperature monitoring sensors (Mirror Assembly, CCD Assembly, Data Electronics Box & Power Electronics Box) to meet criteria		Operating Voltage, Temperature Range & Resolution per Paragraph 3.2.3.4.3, IRD SJ-E007077		X	

2.3 - 30

VERIFICATION REQUIREMENTS AND SPECIFICATIONS					EFFECTIVITY	
NUMBER	REQUIREMENT STATEMENT	MEAS / STIM	CRITERIA AND SPECIFICATIONS	REMARKS/ CONSTRAINTS	MSFC	LORAL
1.2	ENVIRONMENTAL TESTS			Functional Testing shall be performed prior to and following each environmental test and during thermal vacuum and EMC testing.		
				Inspection of hardware will also be conducted before and after each environmental test to ensure no physical degradation has occurred.		
1.2.1	Sinusoidal Vibration Test					
1.2.1.1	Verify by inspection that the vibration accelerometers are located as specified		Appendix I		X	
1.2.1.2	Verify by test that the SXI meets all functional requirements after exposure to the sine vibration criteria		1) Figure 14, IRD SJ-E007077 (Sine Vibration)	Boatflight Test Levels. Levels Applied at the SXI/GOES Interface	X	
1.2.1.3	Verify by inspection that the fastener torques meet criteria after exposure to the sine vibration environment		TBD		X	
1.2.2	Sine Diagnostic (Sweep) Test					

EXAMINABLE

VERIFICATION REQUIREMENTS AND SPECIFICATIONS					EFFECTIVITY	
NUMBER	REQUIREMENT STATEMENT	MEAS / STIM	CRITERIA AND SPECIFICATIONS	REMARKS/ CONSTRAINTS	MSFC	LORAL
1.2.2.1	Verify by inspection that the sine sweep accelerometers are located as specified		Appendix II		X	
1.2.2.2	Verify Sine Diagnostic Test Profile Data Levels		TBD	Protoflight Test Levels. Levels Applied at the SXI/GOES Interface	X	
1.2.2.3	Verify by inspection that the fastener torques meet criteria after exposure to the sine sweep environment		TBD		X	
1.2.3	<b>Random Vibration Test</b>					
1.2.3.1	Verify by inspection that the vibration accelerometers are located as specified		Appendix III		X	
1.2.3.2	Verify by test that the SXI meets all functional requirements after exposure to the random vibration criteria		1) Figure 15, IRD SJ-E007777 (Random Vibration)	Protoflight Test Levels. Levels Applied at the SXI/GOES Interface	X	
1.2.3.3	Verify by inspection that the fastener torques meet criteria after exposure to the random vibration environment		TBD		X	
1.2.4	<b>Shock Test</b>					

# VERIFICATION REQUIREMENTS AND SPECIFICATIONS

## EFFECTIVITY

NUMBER	REQUIREMENT STATEMENT	MEAS / STIM	CRITERIA AND SPECIFICATIONS	REMARKS/ CONSTRAINTS	EFFECTIVITY	
					MSFC	LORAL
1.2.4.1	Verify by inspection that the shock accelerometers are located as specified		Appendix IV		X	
1.2.4.2	Verify by test that the SXI meets all functional requirements after exposure to the shock criteria		1) Figure 16, IRD SJ-E007077 (Shock)	Protoflight Test Levels. Levels Applied at the SXI/GOES Interface	X	
1.2.4.3	Verify by inspection that the fastener torques meet criteria after exposure to the shock environment		TBD		X	
1.2.5	<b>Acoustic Test</b>					
1.2.5.1	Verify by test that the SXI meets all functional requirements after exposure to the acoustic noise criteria		1) Figure 17, IRD SJ-E007077 (Acoustic)		X	
1.2.5.2	Verify by inspection that the acoustic sensors/accelerometers are located as specified		Appendix V		X	
1.2.6	<b>Thermal Vacuum Test</b>					
1.2.6.1	Verify by inspection that the thermocouples are located as specified		Appendix VI		X	
1.2.6.2	Verify Thermal Vacuum Test Profile Data Levels		Appendix VII		X	

2.3 - 34

VERIFICATION REQUIREMENTS AND SPECIFICATIONS					EFFECTIVITY	
NUMBER	REQUIREMENT STATEMENT	MEAS / STIM	CRITERIA AND SPECIFICATIONS	REMARKS/ CONSTRAINTS	MSFC	LORAL
1.2.6.3	Verify by test that the alignment of the optical axis of the HASS to the optical axis of the telescope meets criteria through the operating temperature range of the SXI		Alignment does not vary by more than 10 arc-sec		X	
1.2.7	<b>Thermal Balance Test</b>					
1.2.7.1	Verify by test and supporting analysis that the SXI maintains hardware temperatures while on orbit within the criteria limits		CEI Table 3.18-1		X	
1.2.7.2	Verify by test that the alignment of the optical axis of the HASS to the optical axis of the telescope meets criteria while SXI is in thermal equilibrium		1) Alignment does not vary by more than 5 arc-sec		X	
			2) Thermal Equilibrium TBD +/- 2 degrees C			
1.2.7.3	Verify by inspection that the thermocouples are located as specified		Appendix VIII		X	
1.2.7.4	Verify Thermal Balance Test Profile Data Levels		Appendix IX		X	
1.2.8	<b>EMC Test</b>					
1.2.8.1	<b>Radiated Emissions Test</b>					

## VERIFICATION REQUIREMENTS AND SPECIFICATIONS

VERIFICATION REQUIREMENTS AND SPECIFICATIONS					EFFECTIVITY													
NUMBER	REQUIREMENT STATEMENT	MEAS / STIM	CRITERIA AND SPECIFICATIONS	REMARKS/ CONSTRAINTS	MSFC	LORAL												
1.2.8.1.1	Verify by test that the SXI radiated electric field emissions do not exceed limits of the broadband criteria (3.2.3.9.3)		Figure 26, IRD SJ-E007077	MIL-STD-462	X													
1.2.8.1.2	Verify by test that the SXI radiated electric field emissions do not exceed limits of the narrowband criteria (3.2.3.9.3)		Figure 27, IRD SJ-E007077	MIL-STD-462	X													
1.2.8.2	<b>Radiated Susceptibility Test</b>																	
1.2.8.2.1	Verify by test that the SXI functions while being subjected to the spacecraft electric field emissions (3.2.3.9.4)		<table border="1" style="width: 100%; border-collapse: collapse;"> <thead> <tr> <th style="text-align: left;">Frequency Range</th> <th style="text-align: left;">Level</th> </tr> </thead> <tbody> <tr> <td>14kHz - 3 GHz</td> <td>2 V/m</td> </tr> <tr> <td>1.694GHz</td> <td>15 V/m</td> </tr> <tr> <td>2 GHz - 12 GHz</td> <td>5 V/m</td> </tr> <tr> <td>2.209086GHz</td> <td>10 V/m</td> </tr> <tr> <td>2.208586GHz</td> <td>10 V/m</td> </tr> </tbody> </table>	Frequency Range	Level	14kHz - 3 GHz	2 V/m	1.694GHz	15 V/m	2 GHz - 12 GHz	5 V/m	2.209086GHz	10 V/m	2.208586GHz	10 V/m	MIL-STD-462	X	
Frequency Range	Level																	
14kHz - 3 GHz	2 V/m																	
1.694GHz	15 V/m																	
2 GHz - 12 GHz	5 V/m																	
2.209086GHz	10 V/m																	
2.208586GHz	10 V/m																	
1.2.8.3	<b>Conducted Emissions Test</b>																	
1.2.8.3.1	Verify by test that the SXI equipment which do not have power interfaces with the GOES spacecraft but with other SXI equipment meets the conducted emission criteria		1) Power Line +/-5.2 V ; Limit 200mV 2) Power Line +/- 20V ; Limit 200mV 3) Power Line 5V ; Limit 200mV		X													
1.2.8.3.2	Verify by test that the conducted emissions generated by SXI to the GOES at the power bus interface (steady state) does not exceed criteria		Paragraph 3.2.3.1.11, IRD SJ-E007077		X													

# VERIFICATION REQUIREMENTS AND SPECIFICATIONS

## EFFECTIVITY

NUMBER	REQUIREMENT STATEMENT	MEAS / STIM	CRITERIA AND SPECIFICATIONS	REMARKS/ CONSTRAINTS	MSFC	LORAL
1.2.8.3.3	Verify by test that the conducted emissions generated by SXI to the GOES at the power bus interface (transient) does not exceed criteria		Paragraph 3.2.3.1.12, IRD SJ-E007077		X	
1.2.8.3.4	Verify by test that the conducted emissions generated by SXI to the GOES at the DC/DC Converter On/Off Control interface does not exceed criteria		Paragraph 3.2.3.3, IRD SJ-E007077		X	
1.2.8.3.5	Verify by test that the conducted emissions generated by SXI to the GOES at the telemetry interface (analog) does not exceed criteria		Paragraph 3.2.3.4.1, IRD SJ-E007077		X	
1.2.8.3.6	Verify by test that the conducted emissions generated by SXI to the GOES at the telemetry interface (Bi-level, Type A, TTL) does not exceed criteria		Paragraph 3.2.3.4.2, IRD SJ-E007077		X	
1.2.8.3.7	Verify by test that the conducted emissions generated by SXI to the GOES at the command interface (latching relay) does not exceed criteria		Paragraph 3.2.3.5.1, IRD SJ-E007077		X	
1.2.8.3.8	Verify by test that the conducted emissions generated by SXI to the GOES at the command interface (proportional) does not exceed criteria		Paragraph 3.2.3.5.2, IRD SJ-E007077		X	

2.3 - 36

REPLACEMENT

VERIFICATION REQUIREMENTS AND SPECIFICATIONS					EFFECTIVITY	
NUMBER	REQUIREMENT STATEMENT	MEAS / STIM	CRITERIA AND SPECIFICATIONS	REMARKS/ CONSTRAINTS	MSFC	LORAL
1.2.8.3.9	Verify by test that the conducted emissions generated by SXI output data to the GOES at the interface does not exceed criteria		Paragraph 3.2.3.6.1, IRD SJ-E007077		X	
1.2.8.3.10	Verify by test that the conducted emissions generated by other SXI interface signals to the GOES do not exceed criteria		Paragraph 3.2.3.8.1, IRD SJ-E007077		X	
1.2.8.4	<b>Conducted Susceptibility Test</b>					
1.2.8.4.1	Verify by test that the SXI meets performance requirements due to the conducted susceptibility criteria fed back from the GOES at the power bus interface (steady state)		Paragraph 3.2.3.1.9, IRD SJ-E007077		X	
1.2.8.4.2	Verify by test that the SXI meets performance requirements due to the conducted susceptibility criteria fed back from the GOES at the power bus interface (transient)		Paragraph 3.2.3.1.10, IRD SJ-E007077		X	
1.2.8.4.3	Verify by test that the SXI meets performance requirements due to the conducted susceptibility criteria fed back from the GOES at the heater on/off power interface (steady state)		Paragraph 3.2.3.1.9, IRD SJ-E007077		X	
1.2.8.4.4	Verify by test that the SXI meets performance requirements due to the conducted susceptibility criteria fed back from the GOES at the heater on/off power interface (transient)		Paragraph 3.2.3.1.10, IRD SJ-E007077		X	



# VERIFICATION REQUIREMENTS AND SPECIFICATIONS

## EFFECTIVITY

NUMBER	REQUIREMENT STATEMENT	MEAS / STIM	CRITERIA AND SPECIFICATIONS	REMARKS/ CONSTRAINTS	EFFECTIVITY	
					MSFC	LORAL
1.2.8.4.5	Verify by test that the SXI meets performance requirements due to the conducted susceptibility criteria fed back from the GOES at the DC/DC Converter On/Off Control interface		Paragraph 3.2.3.3, IRD SJ-E007077		X	
1.2.8.4.6	Verify by test that the SXI meets performance requirements due to the conducted susceptibility criteria fed back from the GOES at the telemetry interface (analog)		Paragraph 3.2.3.4.1, IRD SJ-E007077		X	
1.2.8.4.7	Verify by test that the SXI meets performance requirements due to the conducted susceptibility criteria fed back from the GOES at the telemetry interface (Bi-level, Type A, TTL)		Paragraph 3.2.3.4.2, IRD SJ-E007077		X	
1.2.8.4.8	Verify by test that the SXI meets performance requirements due to the conducted susceptibility criteria fed back from the GOES at the temperature sensors interface		Paragraph 3.2.3.4.3, IRD SJ-E007077		X	
1.2.8.4.9	Verify by test that the SXI meets performance requirements due to the conducted susceptibility criteria fed back from the GOES at the command interface (Latching Relay)		Paragraph 3.2.3.5.1, IRD SJ-E007077		X	

UNCLASSIFIED

2.3 - 38

# VERIFICATION REQUIREMENTS AND SPECIFICATIONS

## EFFECTIVITY

NUMBER	REQUIREMENT STATEMENT	MEAS / STIM	CRITERIA AND SPECIFICATIONS	REMARKS/ CONSTRAINTS	EFFECTIVITY	
					MSFC	LORAL
1.2.8.4.10	Verify by test that the SXI meets performance requirements due to the conducted susceptibility criteria fed back from the GOES at the command interface (proportional)		Paragraph 3.2.3.5.2, IRD SJ-E007077		X	
1.2.8.4.11	Verify by test that the SXI meets performance requirements due to the conducted susceptibility criteria fed back from the GOES at the SXI output data interface		Paragraph 3.2.3.6.1, IRD SJ-E007077		X	
1.2.8.4.12	Verify by test that the SXI meets performance requirements due to the conducted susceptibility criteria fed back from the GOES due to other interface signals		Paragraph 3.2.3.8.1, IRD SJ-E007077		X	
1.2.9	<b>Outgassing/Offgassing Test</b>					
1.2.9.1	Verify by test and supporting analysis that the optical bench's internal outgassing of water and other volatiles meets criteria		Less than TBD		X	
1.2.10	<b>Ascent Pressure Test</b>					
1.2.10.1	Verify by test that the SXI meets all functional requirements after exposure to the launch/ascent pressure criteria		Increasing: 14mm Hg/sec Decreasing: 59.9 Hg/sec Appendix X		X	
2	<b>ANALYSES</b>					

2.3 - 39

UNCLASSIFIED

VERIFICATION REQUIREMENTS AND SPECIFICATIONS					EFFECTIVITY	
NUMBER	REQUIREMENT STATEMENT	MEAS / STIM	CRITERIA AND SPECIFICATIONS	REMARKS/ CONSTRAINTS	MSFC	LORAL
2.1	Structural					
2.1.1	Verify by analysis that the structural design maintains the SXI image quality for the specified conditions		1) Any time-of-day 2) Any season of the year 3) Exclude eclipse periods		X	
2.1.2	Verify by analysis that the SXI design for structural strength meets specification		MSFC-HDBK-505A		X	
2.1.3	Verify by analysis that the factors of safety for glass structures meet criteria		Analysis Only - 5.0 Bonds for Structural Glass - 2.0		X	
2.1.4	Verify by analysis that the structural joints using adhesive bonds meet criteria		4-basis strength properties using the specified material, configurations, process and environments for the bond		X	
2.1.5	Verify by analysis that the total x-ray path obscuration for all support structures meets criteria		Less than or equal to 10%		X	
2.1.6	Verify by analysis that the structural design maintains the focal distance criteria		Maintained to +/- .001 inches		X	
2.1.7	Verify by analysis that the SXI aperture plate assembly (including prefilter frames) meets the obscuration criteria		Less than or equal to 10% obscuration of the frontal area of the mirror		X	

VERIFICATION REQUIREMENTS AND SPECIFICATIONS					EFFECTIVITY	
NUMBER	REQUIREMENT STATEMENT	MEAS / STIM	CRITERIA AND SPECIFICATIONS	REMARKS/ CONSTRAINTS	MSFC	LORAL
2.1.8	Verify by analysis that the optical bench light leakage that would produce background noise increase in the detector is not present for integration periods as specified		Up to 10 seconds		X	
2.1.9	Verify by analysis that the combined leak rate of all detector housing feedthroughs meets criteria		Less than TBD		X	
2.1.10	Verify by analysis that the SXI aperture plate assembly's (including prefilter frames) blurring or shading of the image meets criteria		No vignette within half a degree of the optical axis		X	
2.1.11	Verify by analysis that the non-destructive evaluation for SXI composite structure meets specification		MSFC-STP-1249 MSFC-STP-1247		X	
2.2	<b>Dynamic</b>					
2.2.1	Verify by analysis that the SXI Telescope when subject to the static load, vibration, shock and acoustic environments of the spacecraft does not exceed the dynamic envelope (3.1.1.3.3)		Figure 11E, IRD SJ-E007077		X	
2.2.2	Verify by analysis that the ground handling, storage and transportation vibrations for SXI will be below the SXI vibration (random and sine) design criteria for which it is tested		1) Figure 14, IRD SJ-E007077 (Sine Vibration)		X	

VERIFICATION REQUIREMENTS AND SPECIFICATIONS					EFFECTIVITY	
NUMBER	REQUIREMENT STATEMENT	MEAS / STIM	CRITERIA AND SPECIFICATIONS	REMARKS/ CONSTRAINTS	MSFC	LORAL
			2) Figure 15, IRD SJ-E007077 (Random Vibration)			
2.2.3	Verify by analysis that the ground handling, storage and transportation shock loads for SXI will not exceed the SXI shock design criteria for which it is tested		1) Figure 16, IRD SJ-E007077 (Shock)		X	
2.2.4	Verify by analysis and supporting test data that the SXI telescope and electronic boxes natural frequency meets criteria		Greater than 65 Hz		X	
2.3	Thermal					
2.3.1	Verify by analysis that the thermal design maintains the SXI image quality for the specified conditions		1) Any time of day 2) Any season of the year 3) Exclude eclipse periods		X	
2.3.2	Verify by analysis that the thermal control system is designed to maintain temperature limits with the electrical dissipation criteria		CEI Table 3.18-2		X	
2.3.3	Verify by analysis that the maximum change in focal length due to thermal distortions meets criteria during image acquisition mode		1) No more than TBD in. 2) Corresponds to a TBD change in temperature of the optical bench assembly		X	
2.3.4	Verify by analysis that the deviation of the focal point in the plane due to thermal distortions meets criteria during image acquisition mode		1) No more than TBD in. from the center of the sensor 2) Corresponds to a TBD change in temperature of the SXI telescope		X	

VERIFICATION REQUIREMENTS AND SPECIFICATIONS					EFFECTIVITY	
NUMBER	REQUIREMENT STATEMENT	MEAS / STIM	CRITERIA AND SPECIFICATIONS	REMARKS/ CONSTRAINTS	MSFC	LORAL
2.3.5	Verify by analysis that the thermal distortions in the mirror meets criteria		1) No more than TBD in. in the radial direction and TBD in. in the longitudinal direction 2) Corresponds to a TBD change in temperature of the mirror		X	
2.3.6	Verify by analysis that the pre-launch thermal criteria possibly experienced by SXI does not exceed that thermal criteria for which SXI will be tested		TBD		X	
2.3.7	Verify by analysis that the launch/ascent thermal criteria possibly experienced by SXI does not exceed that thermal criteria for which SXI will be tested		TBD		X	
2.3.8	Verify by analysis that the ground handling, storage and transportation thermal criteria possibly experienced by SXI does not exceed than thermal criteria for which SXI will be tested		TBD		X	
2.4	<b>Materials</b>					
2.4.1	Verify by inspection/analysis that the finishes used on SXI meet specification and criteria		1) MSFC-SPEC-250A 2) No galling of contacting surfaces		X	
2.4.2	Verify by inspection/analysis that brazing used on SXI meets specification		MIL-B-7883B		X	

# VERIFICATION REQUIREMENTS AND SPECIFICATIONS

## EFFECTIVITY

NUMBER	REQUIREMENT STATEMENT	MEAS / STIM	CRITERIA AND SPECIFICATIONS	REMARKS/ CONSTRAINTS	MSFC	LORAL
2.4.3	Verify by inspection/analysis that all metallic materials used on SXI meet material properties specification		MIL-HDBK-5E		X	
2.4.4	Verify by inspection/analysis that the graphite epoxy composite structure used on SXI meets the material properties specification		MIL-HDBK-17B		X	
2.4.5	Verify by inspection/analysis that all materials used on SXI meet specification and are selected in accordance with specification		MSFC-STD-506 MSFC-HDBK-527		X	
2.4.6	Verify by inspection/analysis that all materials subject to exposure to propellants and/or their fumes shall be compatible with the concentration and exposure criteria (3.2.2.6D)		Up to 25 ppm for periods up to 15 minutes duration		X	
2.4.7	Verify by inspection/analysis that all EEE components meet the radiation resistance criteria or are spot-shielded to meet the criteria		30 K-rads (Si)		X	
2.4.8	Verify by inspection/analysis that the materials used on SXI meet the flammability specification		NHB8060.1		X	
2.4.9	Verify by inspection/analysis that all materials used on SXI meets the thermal vacuum stability specification		JSC-SP-R-0022		X	

2.3 - 44

VERIFICATION REQUIREMENTS AND SPECIFICATIONS					EFFECTIVITY	
NUMBER	REQUIREMENT STATEMENT	MEAS / STIM	CRITERIA AND SPECIFICATIONS	REMARKS/ CONSTRAINTS	MSFC	LORAL
2.4.10	Verify by inspection/analysis that all metallic materials used on SXI meets the stress corrosion specification		MSFC-SPEC-522		X	
2.4.11	Verify by analysis that the SXI insulating materials and/or surfaces meet the electrostatic sensitivity criteria		Resistivity-thickness product of less than $10^{**9}$ ohm*cm**2		X	
2.4.12	Verify by analysis that the MCP contamination protection after SXI deployment meets criteria		MCP remains protected due to outgassing of materials for TBD hours		X	
2.5	<b>Venting</b>					
2.5.1	Verify by analysis that the SXI equipment that is not hermetically sealed or potted has venting capability to meet the external pressure rate of change (3.2.2.1D)		Steady State: 0.1 nanoTorr minimum, 815 mm Hg maximum Increasing: 14 mm Hg/sec maximum Decreasing: 59.9 mm Hg/sec maximum		X	
2.5.2	Verify by analysis that the SXI optical bench's vent rate meets criteria to preclude damage to the filters		Greater than or equal to TBD rate		X	
2.6	<b>Mass Properties</b>					
2.6.1	Verify by analysis that the SXI's moment of inertia (MOI) is below the maximum criteria		I(xx) = 247.08 lb-in**2 I(yy) = 3422.31 lb-in**2 I(zz) = 3383.52 lb-in**2		X	
2.7	<b>Humidity</b>					

2.3 - 45



# VERIFICATION REQUIREMENTS AND SPECIFICATIONS

## EFFECTIVITY

NUMBER	REQUIREMENT STATEMENT	MEAS / STIM	CRITERIA AND SPECIFICATIONS	REMARKS/ CONSTRAINTS	EFFECTIVITY	
					MSFC	LORAL
2.7.1	Verify by analysis that the SXI could survive exposure to the prelaunch humidity criteria		Minimum 30% Maximum 60%		X	
2.7.2	Verify by analysis that the SXI could survive exposure to the launch/ascent humidity criteria		TBD		X	
2.7.3	Verify by analysis that the SXI could survive exposure to the ground handling humidity criteria		TBD		X	
2.8	<b>Pressure</b>					
2.8.1	Verify by analysis that the SXI is capable of meeting all functional requirements while being exposed to the on-orbit pressure criteria		$10^{-10}$ Torr, Steady State		X	
2.8.2	Verify by analysis that the SXI is capable of meeting all functional requirements after exposure to the prelaunch pressure criteria		TBD		X	
2.8.3	Verify by analysis that the SXI is capable of meeting all functional requirements after exposure to the ground handling, storage and transportation pressure criteria		TBD		X	
2.9	<b>Power</b>					

2.3 - 46

## VERIFICATION REQUIREMENTS AND SPECIFICATIONS

VERIFICATION REQUIREMENTS AND SPECIFICATIONS					EFFECTIVITY	
NUMBER	REQUIREMENT STATEMENT	MEAS / STIM	CRITERIA AND SPECIFICATIONS	REMARKS/ CONSTRAINTS	MSFC	LORAL
2.9.1	Verify by analysis that the SXI survival heater power drawn from the survival power bus and distributed to the optical bench, the power electronics box and the data electronics box meets criteria		11W		X	
2.9.2	Verify by analysis that the SXI survival power during preorbital and eclipse operation meets criteria		Less than or equal to 11W		X	
2.9.3	Verify by analysis that the power dissipated by the SXI over the input bus voltage range meets criteria (3.2.3.1.7)		TBD		X	
2.9.4	Verify by analysis that the in-rush current used by SXI upon turn-on meets criteria (3.2.3.1.13)		Less than 10% of the nominal operating current		X	
2.10	<b>Life</b>					
2.10.1	Verify by analysis that the SXI is designed to meet requirements during the on-orbit operational life criteria, followed by the shelf life criteria		On-orbit life of 3 years with a goal of 5 years. Shelf life of up to 5 years		X	
2.11	<b>Magnetic</b>					
2.11.1	Verify by analysis that the magnetic field of the SXI equipment meets criteria		Less than 10 nanoteslas in each axis at a distance of one meter from the equipment		X	

2.3 - 47

# VERIFICATION REQUIREMENTS AND SPECIFICATIONS

VERIFICATION REQUIREMENTS AND SPECIFICATIONS					EFFECTIVITY	
NUMBER	REQUIREMENT STATEMENT	MEAS / STIM	CRITERIA AND SPECIFICATIONS	REMARKS/ CONSTRAINTS	MSFC	LORAL
2.12	<b>Radiation</b>					
2.12.1	Verify by analysis that the SXI radiation protection assures reliable performance of all parts for the lifetime of the instrument while being exposed to the satellite radiation environment		Specification X-601-84-2		X	
2.12.2	Verify by analysis that the SXI design will withstand the total dose radiation environment criteria		30K-rads		X	
2.12.3	Verify by analysis that the SXI is capable of meeting all functional requirements while being exposed to the on-orbit Earth radiation criteria		237 +/- 36 W/m**2 (75 +/- 12 Btu/hr•ft**2)		X	
2.12.4	Verify by analysis that the SXI is capable of meeting all functional requirements while being exposed to the on-orbit Earth Albedo criteria		.3 +/- .12		X	
2.12.5	Verify by analysis that the SXI is capable of meeting all functional requirements while being exposed to the on-orbit solar radiation criteria		1353 +/- 88 W/m**2 (429 +/- 28 Btu/hr•ft**2)		X	
2.13	<b>Loads</b>					
2.13.1	Verify by analysis that the SXI is capable of withstanding the acceleration loads criteria		12.7 g's - x axis 14.7 g's - y axis 7.2 g's - z axis		X	

2.3 - 48

## VERIFICATION REQUIREMENTS AND SPECIFICATIONS

### EFFECTIVITY

NUMBER	REQUIREMENT STATEMENT	MEAS / STIM	CRITERIA AND SPECIFICATIONS	REMARKS/ CONSTRAINTS	MSFC	LORAL
2.14	<b>Micrometeoroid</b>					
2.14.1	Verify by analysis that the SXI design will meet the criteria of experiencing no critical failure due to meteoroid impacts for a mission life of three (3) years.		Minimum probability of 0.95%	Meteoroid environment shall be as specified in SSP30425	X	
2.15	<b>Electrical</b>					
2.15.1	Verify by analysis that the SXI electrostatic discharge control meets specification		MSFC-SPEC-1493		X	
2.15.2	Verify by analysis that the maximum allowable charge buildup on the optical bench structure meets criteria		Less than or equal to TBD Volts		X	
2.15.3	Verify by analysis that the SXI high voltage design meets specification to prevent corona		MSFC-STB-531		X	
2.15.4	Verify by analysis that the SXI is designed to operate in the geostationary orbit trapped charged particle environment		TBD		X	
2.15.5	Verify by analysis of the timeline that the SXI is capable of meeting all performance requirements once in orbit to meet the time of operation criteria		1) Within 168 hours after power up 2) From 30 minutes after spacecraft down until spacecraft sunset		X	

2.3 - 49

REPLACEMENT

VERIFICATION REQUIREMENTS AND SPECIFICATIONS					EFFECTIVITY	
NUMBER	REQUIREMENT STATEMENT	MEAS / STIM	CRITERIA AND SPECIFICATIONS	REMARKS/ CONSTRAINTS	MSFC	LORAL
2.15.6	Verify by analysis that SXI is capable of surviving per criteria in an unpowered configuration during post launch deployment		Maximum of 2.5 Hours		X	
2.15.7	Verify by analysis that the short term and long term frequency stability of all data transmitted to the MDL meets criteria		Short Term: Greater than or equal to TBD Long Term: Greater than or equal to TBD		X	
2.16	<b>Pointing</b>					
2.16.1	Verify by analysis that the absolute pointing errors contributed by any permanent shift in alignment due to the graphite/epoxy optical bench outgassing meets criteria		Less than or equal to TBD arcsec		X	
2.16.2	Verify by analysis that the absolute pointing errors contributed by any permanent shift in alignment due to variations arising from the expected seasonal and diurnal thermal environments meets criteria		Less than or equal to 30 arcsec		X	
2.16.3	Verify by analysis that the absolute pointing errors contributed by any permanent shift in alignment due to the launch vibration environment meets criteria		Less than or equal to 30 arcsec		X	

VERIFICATION REQUIREMENTS AND SPECIFICATIONS					EFFECTIVITY	
NUMBER	REQUIREMENT STATEMENT	MEAS / STIM	CRITERIA AND SPECIFICATIONS	REMARKS/ CONSTRAINTS	MSFC	LORAL
2.16.4	Verify by analysis that the absolute pointing errors contributed by instrument pointing misalignment and mechanical uncertainties meets criteria		Less than or equal to 30 arcsec		X	
2.16.5	Verify by analysis that the absolute pointing errors contributed by centration errors due to mechanical tolerances meets criteria		Less than TBD arcsec		X	
2.16.6	Verify by analysis that the absolute pointing errors contributed by the SXI instrument to the overall pointing budget meets criteria		Less than or equal to 2.0 arcmin East-West, 2.0 arcmin North-South, and 0.5 deg LOS with respect to the solar/Earth-Equatorial Reference Axis		X	
3	<b>DEMONSTRATION</b>					
3.1	<b>Mounting</b>					
3.1.1	Verify by demonstration the capability to mount the SXI Telescope to the Instrument Mounting Panel (3.1.1.2.1)		Figure 9, IRD SJ-E007077, Eight Mounting Places			X
3.1.2	Verify by demonstration the capability to mount the SXI Power Electronics Box to its respective Mounting Panel (3.1.1.2.2)		Figure 10A, IRD SJ-E007077, Six Mounting Places			X
3.1.3	Verify by demonstration the capability to mount the SXI Data Electronics Box to its respective Mounting Panel (3.1.1.2.2)		Figure 10B, IRD SJ-E007077, Eight Mounting Places			X

# VERIFICATION REQUIREMENTS AND SPECIFICATIONS

## EFFECTIVITY

NUMBER	REQUIREMENT STATEMENT	MEAS / STIM	CRITERIA AND SPECIFICATIONS	REMARKS/ CONSTRAINTS	EFFECTIVITY	
					MSFC	LORAL
3.1.4	Verify by demonstration the capability to mount the SXI HASS Electronics Box to its respective Mounting Panel (3.1.1.2.2)		Figure 10C, IRD SJ-E007077, Four Mounting Places			X
3.2	<b>Filter Changeout</b>					
3.2.1	Verify by demonstration and test that after changeout of the telescope prefilters, the mirror alignment still meets criteria		TBD		X	
3.2.2	Verify by demonstration and test that after changeout of the filter wheel filters, the mirror alignment still meets criteria		TBD		X	
3.3	<b>Cable Connect/Disconnect</b>					
3.3.1	Verify by demonstration the capability of connecting/disconnecting the high voltage cables		High voltage cables can be disconnected/connected from the HVPS housing		X	
4	<b>INSPECTION</b>					
4.1	<b>Envelope</b>					
4.1.1	Verify by inspection that the SXI Telescope, including MLI, telescope connector, cable connector, harness supports and portion of cable in support does not exceed the static envelope (3.1.1.3.1)		Figure 11A, IRD SJ-E007077		X	

VERIFICATION REQUIREMENTS AND SPECIFICATIONS					EFFECTIVITY	
NUMBER	REQUIREMENT STATEMENT	MEAS / STIM	CRITERIA AND SPECIFICATIONS	REMARKS/ CONSTRAINTS	MSFC	LORAL
4.1.2	Verify by inspection that the SXI Power Electronics Box, including its mounting feet and grounding hardware does not exceed the static envelope (3.1.1.3.2)		Figure 11B, IRD SJ-E007077		X	
4.1.3	Verify by inspection that the SXI Data Electronics Box, including its mounting feet and grounding hardware does not exceed the static envelope (3.1.1.3.2)		Figure 11C, IRD SJ-E007077		X	
4.1.4	Verify by inspection that the SXI HASS Electronics Box, including its mounting feet and grounding hardware does not exceed the static envelope (3.1.1.3.2)		Figure 11D, IRD SJ-E007077		X	
4.1.5	Verify by inspection that the SXI Telescope alignment reference fits within the SXI Telescope static envelope (3.1.1.4.1)		Figure 11E, IRD SJ-E007077		X	
4.2	<b>SXI Interface</b>					
4.2.1	Verify by inspection that the SXI electrical interface connector pins meets criteria (3.1.2.1.3)		Paragraph 3.1.2.1.3, IRD SJ-E007077		X	
4.2.2	Verify by inspection that the SXI Telescope is equipped with harness supports for its spacecraft interfacing harness (3.1.2.2)		Harness supports located at minimum intervals of six (6) inches		X	



VERIFICATION REQUIREMENTS AND SPECIFICATIONS					EFFECTIVITY	
NUMBER	REQUIREMENT STATEMENT	MEAS / STIM	CRITERIA AND SPECIFICATIONS	REMARKS/ CONSTRAINTS	MSFC	LORAL
4.2.3	Verify by inspection that the SXI/EUV physical interface meets criteria		Power, data and voltage pins are contained in a single D-subminiature connector		X	
4.2.4	Verify by inspection that the SXI/EUV Power Interface physically meets criteria		1) Each power line fused at 50mA 2) A common return line provided		X	
4.2.5	Verify by inspection that the base surface flatness of each SXI Electronics Box meets criteria (3.2.2.1C)		0.010 inch total or less		X	
4.2.6	Verify by inspection that the base surface flatness of the SXI telescope mounting bracket meets criteria (3.2.2.1C)		0.001 inch or less		X	
4.2.7	Verify by inspection that the SXI electrical interface connectors meets criteria (3.1.2.1)		Paragraph 3.1.2.1, IND SPEC E007077		X	
4.3	<b>Assembly</b>					
4.3.1	Verify by inspection that the SXI hardware is assembled per specification		MSFC-PLAN-2252		X	
4.4	<b>Data Format</b>					

VERIFICATION REQUIREMENTS AND SPECIFICATIONS					EFFECTIVITY	
NUMBER	REQUIREMENT STATEMENT	MEAS / STIM	CRITERIA AND SPECIFICATIONS	REMARKS/ CONSTRAINTS	MSFC	LORAL
4.4.1	Verify by inspection that the SXI data content meets criteria		All information necessary to reconstruct the image on the ground, including all free imaging parameters is available		X	
4.4.2	Verify by inspection that the SXI image data content meets criteria		1) Solar Data 2) CCSDS Headers 3) All information necessary for reconstructing the solar image and EUV flux measurements		X	
4.4.3	Verify by inspection that the SXI data meets the transition density criteria		1) Manchester encoded 2) Fill pattern transmitted between CCSDS transfer frames consists of an alternating pattern of 0's and 1's		X	
4.4.4	Verify by inspection that the SXI image, housekeeping, and diagnostic data format meets specification		CCSDS 1923-B-2		X	
4.5	<b>Design &amp; Construction</b>					
4.5.1	Verify by inspection that the SXI power return meets criteria (3.2.3.1.8)		Power return will be brought out separately and not connected to the SXI case		X	
4.5.2	Verify by inspection that the SXI returns for analog and temperature sensor telemetry signals meet criteria (3.2.3.8.1E)		Separate returns for each signal		X	
4.5.3	Verify by inspection that individual circuit shielding meets specification		NHB 5300.4(3G)		X	

# VERIFICATION REQUIREMENTS AND SPECIFICATIONS

## EFFECTIVITY

NUMBER	REQUIREMENT STATEMENT	MEAS / STIM	CRITERIA AND SPECIFICATIONS	REMARKS/ CONSTRAINTS	EFFECTIVITY	
					MSFC	LORAL
4.5.4	Verify by inspection that overall shields meets specification		NHB 5300.4(3G)		X	
4.5.5	Verify by inspection that the SXI MLI blanket metalized surface ground tabs meet criteria		No point on the blanket is more than one meter away from a ground tab		X	
4.5.6	Verify by inspection that the SXI instrument does not contain automatic low voltage shut down circuitry (3.2.3.1.4)		No circuitry will be used to shutdown or disconnect due to low bus voltage below 29.0 VDC		X	
4.5.7	Verify by inspection that all mechanical fasteners used on SXI meet specifications		MSFC-STD-486 MSFC-STD-557 MIL-STD-1515		X	
4.5.8	Verify by inspection that all adhesive bonding used on SXI meet specification		MSFC-STD-445		X	
4.5.9	Verify by inspection that the alignment reference is built per design which provides bore sighting the SXI optical axis to the GOES XRS alignment reference		Design allows boresighting to within 30 arc-sec		X	
4.5.10	Verify by inspection that the hyperboloid stop is located per criteria		43.3 cm +/- 1cm behind the principal plane of the mirror		X	
4.5.11	Verify by inspection that the SXI Telescopes alignment reference is reflective and meets the optically flat criteria. (3.1.1.4.1)		Within one quarter (1/4) of 5461 angstroms.		X	

2.3 - 57

VERIFICATION REQUIREMENTS AND SPECIFICATIONS					EFFECTIVITY	
NUMBER	REQUIREMENT STATEMENT	MEAS / STIM	CRITERIA AND SPECIFICATIONS	REMARKS/ CONSTRAINTS	MSFC	LORAL
4.5.12	Verify by inspection that the SXI filter wheel location meets criteria		The plane containing the filter being illuminated shall be no closer than 0.75 inches to the focal plane		X	
4.5.13	Verify by inspection the location of the SXI Telescope alignment reference on the front aperture side of the telescope (3.1.1.4.1)		TBD		X	
4.5.14	Verify by inspection that the detector housing provides a storage environment for the MCP that meets criteria		1) TBD cleanliness level 2) Oil free 3) Less than or equal to TBD humidity		X	
4.5.15	Verify hardware is marked and serialized for identification		MMI 5300 (1D-2) MMI 5300		X	
4.5.16	Verify electrical and electronic parts and equipment are properly marked		MSFC-STR-383 MIL-STD-130 MSFC-HDBK-527		X	
4.5.17	Verify hardware is marked for shipment and storage		MIL-STD-129		X	
4.5.18	Verify by inspection that the electrical fault protection for SXI meets criteria		1) Circuit protection is fused to a lower current than upstream devices 2) Wiring is sized to be compatible with upstream fusing		X	
4.6	<b>Safety &amp; Mission Assurance</b>					

# VERIFICATION REQUIREMENTS AND SPECIFICATIONS

## EFFECTIVITY

NUMBER	REQUIREMENT STATEMENT	MEAS / STIM	CRITERIA AND SPECIFICATIONS	REMARKS/ CONSTRAINTS	MSFC	LORAL
4.6.1	Verify by inspection that the SXI software quality assurance requirements meet specification		MSFC-PLAN-1975		X	
4.6.2	Verify by inspection that the SXI safety requirements meet specification		MSFC-PLAN-2241		X	
4.6.3	Verify by inspection that the SXI reliability requirements meet specification		MSFC-PLAN-2241		X	
4.6.4	Verify by inspection that the SXI quality assurance requirements meet specification		MSFC-PLAN-2241		X	
4.7	<b>Contamination</b>					
4.7.1	Verify by inspection that the SXI contamination control meets specification		MSFC-PLAN-2242		X	

EFFECTIVE

**EXAMPLE**

PART II  
VERIFICATION REQUIREMENTS AND SPECIFICATIONS  
SUPPORT EQUIPMENT

2.3 - 60

VERIFICATION REQUIREMENTS AND SPECIFICATIONS					EFFECTIVITY	
NUMBER	REQUIREMENT STATEMENT	MEAS / STIM	CRITERIA AND SPECIFICATIONS	REMARKS/ CONSTRAINTS	MSFC	LORAL
1	<b>GROUND SUPPORT EQUIPMENT</b>					
1.1	<b>MECHANICAL GROUND SUPPORT EQUIPMENT (MGSE)</b>					
1.1.1	Verify by inspection that the dry gas used for the dry gas purge system meets specification		MSFC-PROC-404		X	
1.1.2	Verify by test that the purge apparatus filters the purging gas to meet criteria (3.2.2.8.1)		0.5 microns or less		X	
1.1.3	Verify by test that the vacuum pumping station meets the pump criteria		Pump from atmospheric pressure down to at least $1 \times 10^{-6}$		X	
1.1.4	Verify by inspection during test that the vacuum pumping station meets visible pump criteria		Oil and contamination free		X	
1.2	<b>ELECTRICAL GROUND SUPPORT EQUIPMENT (EGSE)</b>					
1.2.1	Verify by inspection that the pin assignments for the EGSE/MDL interface meet criteria (3.4.3.1)		Paragraph 3.4.3.1, IRD SJ-E007077		X	
1.2.2	Verify by inspection that the connector types for the EGSE/MDL interface meet criteria (3.4.3.2)		Paragraph 3.4.3.2, IRD SJ-E007077		X	

VERIFICATION REQUIREMENTS AND SPECIFICATIONS					EFFECTIVITY	
NUMBER	REQUIREMENT STATEMENT	MEAS / STIM	CRITERIA AND SPECIFICATIONS	REMARKS/ CONSTRAINTS	MSFC	LORAL
1.2.3	Verify by test that the clock phase of the EGSE/MDL interface meets criteria (3.4.3.3)		Paragraph 3.4.3.3, IRD SJ-E007077		X	
1.2.4	Verify by test that the power provided by the EGSE to the SXI vacuum pump and calibration sources which require external power meets criteria		TBD		X	
1.2.5	Verify by test that the EGSE provides a SXI/GOES power interface that meets criteria		TBD		X	
1.2.6	Verify by test that the EGSE provides a SXI/GOES PCM telemetry interface that meets criteria (3.2.3.6.1)		Paragraph 3.2.3.6.1, IRD SJ-E007077		X	
1.2.7	Verify by test that the EGSE provides a simulated GOES MDL interface that meets criteria		TBD		X	
1.2.8	Verify by test that the EGSE provides a simulated GOES proportional command number 36 that meets criteria		TBD		X	
1.2.9	Verify by test that the EGSE ADP equipment provides modem capability that meets criteria		Transmits full-frame digital image data and header data using error correction coding at 9600 baud		X	
1.2.10	Verify by test that the EGSE ADP equipment provides data display capability that meets criteria		1) Represents the SXI image data using VGA output capable of at least the 512 by 512 display		X	



## VERIFICATION REQUIREMENTS AND SPECIFICATIONS

### EFFECTIVITY

NUMBER	REQUIREMENT STATEMENT	MEAS / STIM	CRITERIA AND SPECIFICATIONS	REMARKS/ CONSTRAINTS	EFFECTIVITY	
					MSFC	LORAL
			2) Magnifies any arbitrary section of the CCD data for display			
1.2.11	Verify by test that the EGSE ADP equipment provides data processing capability that meets criteria		SXI image data is corrected pixel by pixel using flat field correction files to account for pixel to pixel responsivity variations		X	
1.2.12	Verify by inspection that the EGSE ADP equipment provides data capture and storage capability that meets criteria		1) Storage for at least 100 images 2) Storage retrieval via MS-DOS compatible floppy disks 3) Laser printer capable of 300 x 300 dpi resolution 4) 5600 baud modem for use with standard telephone lines		X	
1.3	<b>TRANSPORTATION &amp; SHIPPING</b>					
1.3.1	Verify by inspection that the special transporters, servicing and handling equipment used to support SXI flight hardware and/or GSE meets specification		NHB6000.1C		X	
1.3.2	Verify by analysis that the SXI shipping container will not be damaged when subjected to load criteria for a truck or air ride trailer		Fore / Aft +/-2.0 g Lateral +/- 2.0g Vertical +3.5g, -1.5g		X	

2.3 - 62

FOR INTERNAL USE

### **2.3.3**

## **VERIFICATION REQUIREMENTS AND SPECIFICATIONS DOCUMENT**

### **EXAMPLE 2**

**THIS PAGE INTENTIONALLY LEFT BLANK**

**SSM VERIFICATION REQUIREMENTS  
AND  
SPECIFICATIONS DOCUMENT  
(VRSO)**

**AV-02**

**SUPPORT SYSTEMS MODULE**

**SPACE TELESCOPE PROJECT**

**EXAMPLE**

THIS PAGE INTENTIONALLY LEFT BLANK

## SSM VERIFICATION REQUIREMENTS AND SPECIFICATIONS DOCUMENT

### TABLE OF CONTENTS

<u>Section</u>		<u>Page</u>
1.0	INTRODUCTION	2.3-69
1.1	Purpose	2.3-69
1.2	Scope	2.3-69
1.3	Change Control	
2.0	SSM COMPONENT VERIFICATION REQUIREMENTS	2.3-69
2.1	Summary	2.3-69
2.2	Test Requirements	2.3-70
2.3	Assessment Requirements	2.3-70
3.0	SSM SUBASSEMBLY VERIFICATION	2.3-70
4.0	EMERGENCY POWER SHUTDOWN	2.3-71
5.0	FUNCTIONAL TEST	2.3-71
5.1	Pre-Power Checks	2.3-72
5.1.1	Requirements	2.3-72
5.1.2	Criteria	2.3-72
5.2	Functional and Special Tests	2.3-72
5.2.1	Requirements	2.3-73
5.2.2	Criteria	2.3-73
5.3	Assembly	2.3-73
5.3.1	Requirements	2.3-73

LIST OF TABLES

Tables

2.2-1	SSM Component Verification Matrix	NA
5.3-1	SSM Support Equipment Configuration and Special Tests	NA

Appendix

A	Functional Test Activities	
---	----------------------------	--

**EXAMPLE**

## SSM COMPONENT VERIFICATION REQUIREMENTS AND SPECIFICATIONS DOCUMENT

### 1.0 INTRODUCTION

#### 1.1 Purpose

This document specifies, by reference to the component specifications, the verification requirements and information necessary for verification of the Systems Support Module (SSM) components. This document, thereby, provides an overview into the SSM component verification program. It also specifies or references the specification requirements for subassembly and SSM-level verification prior to integration of the SSM into the ST. The SSM-ES verification requirements are specified in Appendix A of this document. Appendix B will contain all UP SSM requirements and will be provided later.

#### 1.2 Scope

This document provides a listing of SSM components tabulated in the SSM Component Verification Matrix, and specifies that the component verification requirements are documented in each individual component specification. The requirements cover all activities associated with acceptance verification of the SSM components. The requirements also identify those components requiring various types of analysis rather than test to verify. The component specification includes the requirements and specifications to support the component tests, in accordance with SSD Baseline Test Program for Flight Systems and the ST Project Verification Policy.

### 2.0 SSM COMPONENT VERIFICATION REQUIREMENTS

Verification requirements for the SSM Components are derived from LMSC D154085, the SSD Baseline Test Program for Flight Systems as modified to meet ST Program needs. Detailed test philosophy, organization, controls, and policies are defined in the SSM Component and Sub-assembly A&V Plan LMSC D716672 (AV-01).

#### 2.1 Summary

The SSM Components are defined as "black boxes" which will be assembled on the SSM major subassemblies and interconnected with wire harnesses, cables, or waveguides. Each SSM Component is designed and manufactured according to detail specifications. Each specification or drawing identifies



configuration requirements, performance requirements, and verification requirements of the hardware. Paragraph 3.0 of each detail component specification establishes the physical characteristics and performance requirements for that component. Paragraph 4.0 of each specification constitutes, in conjunction with paragraph 3.0, the SSM Components Verification Requirements and Specifications.

The SSM components shall be verified by both test and assessment (analysis and inspection) methods, using a joint qual/acceptance test program.

## 2.2 Test Requirements

The following summarizes the SSM component test requirements. The SSM Component Verification Matrix summarizing the environmental tests and test levels required for each component is presented in Table 2.2.1.

1. Functional and Performance Tests. Each component shall be tested to verify performance and functional operation during ambient and thermal/vacuum environmental testing. A functional test shall be performed before and after each environmental test. Detail functional test requirements shall be per paragraph 4.0 of the applicable component specification.
2. Burn-in. SSM electrical/electronic components shall receive a minimum of 300 hours burn-in (power on) with the last 100 hours failure free. Simple electrical/electronic components may not require as much burn-in time. Electro-mechanical components do not require a burn-in but shall be subjected to run-in sufficient to stabilize operating characteristics (friction, torque, etc.).
3. Leak Tests. Leak tests shall be performed on sealed components before and after thermal vacuum testing.

## 2.3 Assessment Requirements

SSM component verification requirements to be performed by assessment are specified in paragraph 4.0 of the applicable component specification. Assessment methods include inspection and analysis.

## 3.0 SUBASSEMBLY VERIFICATION

The subassemblies will be verified in accordance with the applicable assembly drawings which specify materials, dimensions and finish, and installation requirements for wire harnesses, cables, waveguides and components. Structural fit checks and alignments shall be performed.

In addition to verifications of major subassemblies, other subassembly tests that are required are:

**Latch and Hinge Subassemblies.** The appropriate rotary drive components are verified and certified as specified in paragraph 2.2 and 2.4, respectively, then used in the construction of the following subassemblies:

- Aperture Door (AD) Latch Assembly (1)
- High Gain Antenna (HGA) Latch Assembly (4)
- Solar Array (SA) Latch Assembly (4)
- Aperture Door (AD) Hinge Assembly (1)
- HGA Hinge Assembly (2)

The latch assemblies and fittings shall be subjected to an inspection, functional test without the rotary drive actuator to determine manual input torque vs. preload torque vs. rotational travel and a functional test with the rotary drive actuator installed to determine the input torque vs. preload at room ambient conditions.

The hinge assemblies (AD & HGA) shall be subjected to an inspection, functional test without the rotary drive actuator unpowered to record the back drive torque of an inertially loaded assembly. Also, adjust, measure and record the powered preload of the deploy stop. AD potentiometer calibration shall be accomplished at initial subsystem installation.

#### 4.0 Emergency Power Shutdown

The requirements of SAV-1020, except that there is no need for the 120 second delay and removal of SSM main bus power can be performed immediately.

#### 5.0 Functional Test

The major subassemblies consist of the Light Shield (LS), Forward Shell (FS), Equipment Section (ES), Aft Shroud (AS), and Aperture Door (AD). As part of the SSM Pre-CART verification activity (see para. 4.0), the components, light baffles, wire harnesses, cables, waveguides, doors, panels, etc. will be

installed in these major subassemblies. The latch and hinge mechanism subassemblies (AD, HGA, SA) shall be verified in accordance with the requirements of para. 3.0 of this document. All of these subassemblies and components shall be certified to comply with the in-process.

The test activity begins after in-process testing. The tests required during the test activity shall include:

1. Functional tests and special tests.
2. Verification during assembly of the subassemblies, flight SA electronics (SADE, DCE Diode box).

The configuration requirement for the flight hardware and the associated support equipment for each of the test activities and for "special test", henceforth defined, is shown in Table 5.3-1.

5.1 Pre-Power Checks. The Pre-Power Checks occur prior to the first power application to the main buses. These checks verify electrical integrity prior to the power application.

#### 5.1.1 Requirements.

- The configuration is specified in Table 5.3-1, activity level 1.
- Verify the electrical interfaces (bus continuity, isolation, and grounding)
- Flight cable isolation resistance and megger checks.

#### 5.1.2 Criteria.

- All electrical interface measurements shall indicate correct installation and connection. Criteria for specific measurable verifications are specified in the appendices of this document.

#### 5.1.3 Constraints. Constraints are defined in paragraph 5.2 and below.

- The main buses are to remain in the OFF condition throughout the Pre-Power test activity.

5.2 Functional and Special Tests. The Function Test is to be performed as the first "all up" functional test (including all electronics). Data derived from this test will be the baseline for evaluation of data derived from subsequent test activity.

### 5.2.1 Requirements.

- The configuration is specified in Table 5.3-1, activity blocks 2 and 3. The flight hardware is to be assembled with the +V1 axis up.
- Verify satisfactory performance and compatibility of all hardware/software (including all electronics). All detail verification requirements compatible with available interfaces for this test. The interfaces will be verified to the extent practical using interface test sets.

### 5.2.2 Criteria.

- The components shall operate and perform within specification limits and tolerances, satisfying all applicable verification requirements.

5.3 Assembly. The general requirements for assembly verifications which occur during assembly are defined below.

### 5.3.1 Requirements.

- The configuration is specified in Table 5.3-1, activity level 4.
- Assemble the subassemblies specified in paragraph 5.3 in accordance with the assembly drawing 417674. (Test batteries will be used in lieu of flight batteries.)
- Assemble the SA electronics (SADE, DCE, Diode Boxes) into the assembly in accordance with the Bay 7 Equipment Installation Drawing LMSC 4171589.
- Assemble the SI C&DH into the assembly in accordance with the Bay 10 Equipment Installation Drawing LMSC 4171589.
- Perform special tests/activities as specified in Table 5.3-1, activity level 4 (or during Pre-Power checks, paragraph 5.3.1).
- Verify electronics/SI C&DH configuration is ready for test.

VERIFICATION REQUIREMENTS  
AND SPECIFICATIONS DOCUMENT

**EXAMPLE**

APPENDIX A  
TEST ACTIVITIES

FUNCTIONAL TEST ACTIVITIES  
APPENDIX A

1.0 INTRODUCTION

The appendix presents requirements applicable to flight hardware to be satisfied during test activities. The specific requirements to be verified during ambient functional test are identified in section 2.0.

1.1 Pre Power Tests. The tests to be completed prior to the start of ambient functional are defined.

1.2 Appendix Contents.

			PAGES
SECTION	1	INTRODUCTION	2.3-75
SECTION	2	REQUIREMENTS	NA
SECTION	3	S&M	2.3-77
SECTION	4	TCS	NA
SECTION	5	EPS	2.3-96
SECTION	6	I&C	NA
SECTION	7	DMS	2.3-151
SECTION	8	PCS	2.3-184
SECTION	9	SAFEMODE	NA

1.3 Detail Verification Requirements Format. The tabulated detail subsystem and interface verification requirements in this section of the document are presented in a format as outlined below.

Column I - Requirement Number

The Dewey decimal system is used to identify each requirement and organize the requirements sequentially according to subject matter.

Column II - Requirement Statement

An identification of the verification to be conducted, the subsystem, component, or interface addressed, the command to be issued or action to be taken, and the parameters to be verified are presented in this column.

Column III - Signal ID

Identification numbers of the measurements are taken from the Space Telescope Command and Instrumentation List, DM-01 and DM-02 respectively. Some verifications in this document will require manual readout of measurements from GSE/STE test points or instruments. Identification of those measurements will also be presented in this column.

#### Column IV - Criteria and Specifications

This column defines the criteria (including acceptable limits and tolerances) to be used in determining acceptable function or performance. All values given in this column consider the actual physical limits, and do not consider onboard telemetry analog to digital conversion tolerances, ground system data compression considerations or ground instrumentation tolerances. The data listed in this column are measured at the indicated measurement point, or as presented in the Spacecraft Automated Test System (SATS).

#### Column V - Conditions/Constraints/Remarks

This column provides the instructions required to define the test methods, constraints, hardware configuration, specific measuring equipment and test sequence, when necessary, to assure attainment of objectives. Remarks are provided when the author feels they will aid in user understanding of the verification under consideration.

### 3.0 STRUCTURES & MECHANISMS AND INTERFACES

#### 3.1 INTRODUCTION AND GENERAL REQUIREMENTS

3.1.1 Scope. This section contains the verification requirements and information necessary for the Structures & Mechanisms (S&M) subsystem and interfaces.

3.1.2 Subsystem Description. The structures subsystem shall provide the structure to mount the subsystems and associated components, crew aids, and shall provide the structural interface with the OTA, SA, and the Orbiter. The S&M subsystem will also provide mechanisms required to operate all appendages and doors.

3.1.4 Definitions. The following terms are used frequently in defining requirements for mechanisms and are defined for clarity.

- a. Hinge Assembly - Hinge assemblies are mechanisms utilized to deploy/retract the HGA and AD assembly. There is one hinge assembly for each of the two HGAs (located on + and -V3 axis of the FS) and one hinge assembly for the AD (located on +V3 axis of the LS). Each hinge assembly consists of an active hinge (with drive) and a passive hinge.
- b. Latch Assembly - Latch assemblies are mechanisms utilized to lock the SAs, HGA and AD to structure. There are two latch assemblies (Fwd and Aft) for each SA ( $\pm$  V2 axis) with one drive per latch assembly, one (1) latch assembly for each HGA ( $\pm$  V3 axis) with one drive per latch assembly, and one latch assembly for the AD with one drive assembly, for a total of nine (9) latches and seven (7) drives.
- c. High Gain Antenna Subsystem (HGAS) - The HGAS consists of 2 Antenna Pointing Systems (APS), 2 Antenna (or Dishes) and 2 Antenna Masts (or booms). The APS consists of a Two Axis Gimbal (TAG) and Gimbal Electronics Assembly (GEA).

3.1.5 General Requirements. For all structures/mechanisms verifications performed under authority of this document, the following general requirements, including both verification by test and by assessment, are applicable. The verification requirements for the RF components of the HGAs are specified in I & E Section.

3.1.5.1 Constraints.

- No commands shall be sent to exercise the rotary drive unless the rotary drive temperature monitor is equal to or greater than -34 deg C (-30 deg F).
- Latch and Hinge assembly functional tests shall be performed with the appendages (SA, HGA, AD) removed.
- The TAG shall be rigidized by GSE strongback at all times except during TAG phasing/functional test.
- When utilizing the Mechanism Control Unit (MCU), the primary and redundant mechanism motors shall not be powered to drive a common element at the same time. This constraint does not apply for the SA.



3.1.5.2 Configuration and Conditions. The following mechanical and electrical configurations apply to testing of the S&M subsystem and interfaces unless otherwise specified herein.

3.1.5.2.1 Mechanical Configuration. The subsystems shall be completely assembled, with +v1 up, and interconnected with flight hardware except:

- SA Development wing shall be used as interface tool until the flight SA becomes available. No operation on the flight SA wings shall be performed unless first being proved on the D/Q wing.
- HGA components (HGA, TAG and Mast), AD and SA will be removed/re-installed from/on the spacecraft for various special tests.

3.1.5.2.2 Electrical Configurations. The S&M subsystems shall be completely assembled and interconnected with flight hardware, except:

- TAG, SA and AD electrical and thermal simulators shall be required for ambient and thermal vacuum tests.

3.1.5.3 GSE/STE Interface. The required GSE/STE to SSM/ST interface requirements are as specified in the GSE/STE Requirements Specifications.

- STE strongbacks shall be provided to rigidize the TAG at all times, except during the TAG function and phasing testing.
- The GSE AD simulator shall be installed whenever the flight AD is removed.
- STE latch tools (for latch activation) and hinge bridges (connecting the drive and passive hinges) shall be used during Latch/Hinge functional interface tests at ambient and in the thermal vacuum chamber.
- The SA Wing and TAG Simulator (SIVS) shall be used during all functional tests.
- A TAG/SA continuity test box shall be used for the TAG continuity test and for the SA continuity test.

- Zero gravity conditions shall be simulated by GSE for all appendage deployment testing.

### 3.2 MECHANISMS AND APPENDAGE DEPLOYMENT VERIFICATION

The mechanisms and Mechanisms Control Unit (MCU) shall undergo a series of functional tests during the test activities. All commands, operation microswitches, mechanical operations and telemetry responses shall be specified as defined in Sections 3.3.1 through 3.3.8 for the following:

- Mechanism Control Unit (MCU)
- MCU/Latch, Hinge Assembly Function I/F Test

The AD full deployment test shall be performed in the VATA with +v1 axis in the horizontal attitude. Zero gravity conditions shall be simulated for the AD deployment. The flight hardware shall not be powered in the horizontal position.

The HGA micro-deployment test shall be performed with the HGA/TAG restrained. This test shall command the latch to open/close and the hinge stepper motor through approximately 500 steps in the deploy/retract directions. A HGA mast only (without the TAG) manual deployment test shall be performed to verify service loop clearances.

SA PDM and SDM command continuity tests shall be performed on the flight and development SA. SADM and PDM command polarity verification shall use test aids (SADM "breadboard" and PDM stepper motor).

VERIFICATION REQUIREMENTS AND SPECIFICATIONS

NUMBER	REQUIREMENT STATEMENT	SIGNAL ID	CRITERIA AND SPECIFICATIONS	CONDITIONS, CONSTRAINTS, REMARKS
3.3	VERIFICATION BY TEST MECHANISMS			<p>The mechanisms functional tests shall not be performed during an allocated functional test. Specific time segments have been assigned prior to the acoustic test, for which the appendages are installed, and after final installation prior to shipment.</p> <p>All commands shall be sent from on-board computer via the MCU to the mechanisms. TAG shall be simulated except during TAG functional test. Preload capability, TLM, and micro-switches shall be functionally verified. Mechanisms operation constraints shall apply.</p>
3.3.1	MECHANISM CONTROL UNIT (MCU)			
3.3.1.1	Verify MCU link power supply turns on in response to command.		Link Power Supply TM monitor indicates on,	<p>Initial conditions:</p> <ul style="list-style-type: none"> <li>• MCU power OFF</li> </ul>
3.3.1.2	Verify 1) control power supply turns on, 2) current regulator turns on, 3) disable current regulator current relay in response to control P/S on command.		<p>1) CNTR PWR TM monitor indicates on,</p> <p>2) Curr regulator TM monitor indicates on,</p> <p>3) Curr relay disable curr operating monitor indicates ON</p>	<p>Initial conditions:</p> <ul style="list-style-type: none"> <li>• Link power ON</li> <li>• Logic power OFF</li> <li>• MTR current regulator OFF</li> </ul>
3.3.1.3	Verify MCU current regulator enable current relay in response to command.		<p>1) Current enable relay monitor indicates enable</p> <p>2) Curr operating TM monitors indicates ON</p>	<p>Initial conditions:</p> <ul style="list-style-type: none"> <li>• Current regulator power ON</li> <li>• Control power supply ON</li> </ul>

2.3 - 80

EXAMINED

VERIFICATION REQUIREMENTS AND SPECIFICATIONS

NUMBER	REQUIREMENT STATEMENT	SIGNAL ID	CRITERIA AND SPECIFICATIONS	CONDITIONS, CONSTRAINTS, REMARKS
3.3.1.4	Verify MCU command and data information a) Serial digital input command b) MCU operate command		TM monitor indicates proper command logic/motor relay selected. TM monitors indicate 1) Motor Oper. curr. 2) Run/Hold flip flop change state 3) Return to original state when motor stops	Initial conditions MCU ON: • Use dummy (no function) load
3.3.1.5	Verify MCU D10 (AD hinge) relay inhibits relays selection a) Send to command to set MCU D10 to command state b) Send command to select any relay c) Send command to disconnect D10 d) Send command to select any arbitrary relay		TM indicates MCU K10 relay latched No change in TM TM indicates MCU K10 unlatched TM indicates MCU relay selected	Initial conditions : • MCU ON • MCU D10 disconnected
3.3.1.6	Verify MCU control power supply turns off in response to command		1) CTRL PWR TM monitor indicates OFF 2) Curr regulator TM monitor indicates OFF 3) Curr relay TM indicates disable, curr operating TM indicates OFF	Initial conditions : • MCU ON • MCU D10 disconnected
3.3.1.7	Verify MCU link power supply turns off in response to command		Link power TM monitor indicates OFF	Initial conditions : • Link power on  Notes: • Latch assembly to be tested without the appendages installed
3.3.2	MCU/LATCH, HINGE ASSEMBLY FUNCTIONAL I/F TEST			• Latch fitting (STE) and hinge bridge (STE) are required for all functional tests  • MCU is on  • All hinges and latches are tested

2.3 - 81

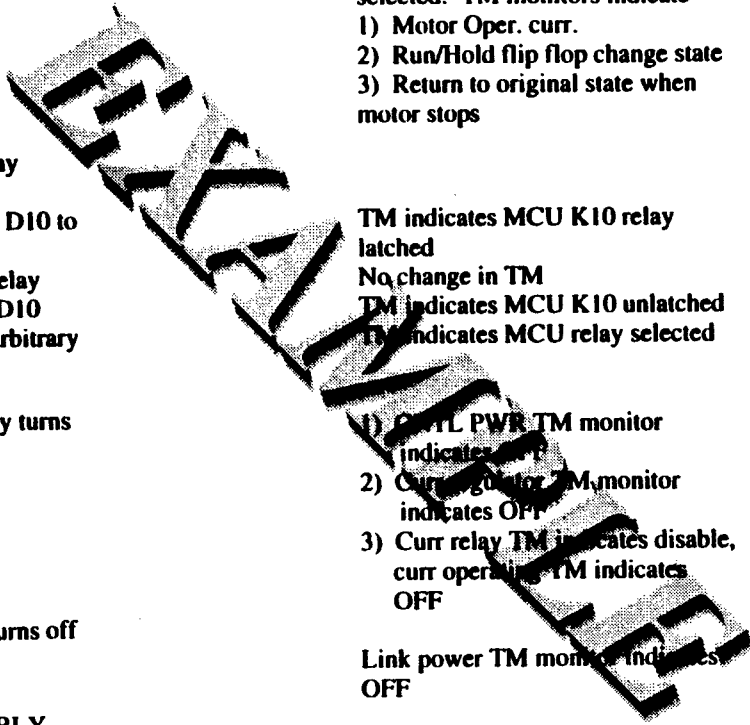

VERIFICATION REQUIREMENTS AND SPECIFICATIONS

NUMBER	REQUIREMENT STATEMENT	SIGNAL ID	CRITERIA AND SPECIFICATIONS	CONDITIONS, CONSTRAINTS, REMARKS
3.3.2.1	Verify AD latch assembly is functionally isolated from others		No TLM or physical interference to other mechanism units	Initial conditions : • AD latch in open position
a)	Send AD latch open logic select command		MCU indicates proper logic & MTR relay	
b)	Send MTR operate command		AD latch microswitch TM monitor indicates change of status	• AD latch in open position
c)	Send AD latch close logic select command		MCU TM monitor indicates proper logic & MTR relay selected	
d)	Send MTR operate command		AD latch microswitch TM monitor indicates change of status (pre-loaded)	
e)	Send AD latch partial open logic select command		MCU TM monitors indicate proper logic & MTR relay selected	Initial conditions: • AD latch in closed and latched position
f)	Send MTR operate command		AD latch HS TM monitor indicates change of status (No TM indication when HS is depressed)	
g)	Send AD latch partial close logic select command		MCU TM monitors indicate proper logic & MTR relay selected	• AD latch in partial open position
h)	Send MTR operate command		AD latch microswitch TM monitor indicates change of status (pre-loaded)	
3.3.2.2	Verify AD hinge assembly is functionally isolated from others		No TLM or physical interference occurs to other mechanism units	Initial Conditions: • AD in closed position
a)	Send AD open logic select command			• MCU K11 (AD hinge) is connected

2.3 - 82

VERIFICATION REQUIREMENTS AND SPECIFICATIONS

NUMBER	REQUIREMENT STATEMENT	SIGNAL ID	CRITERIA AND SPECIFICATIONS	CONDITIONS, CONSTRAINTS, REMARKS
b)	Send MTR operate command	AD hinge microswitch TM monitor indicates change of status AD potentiometer indicates change of angles		Initial Conditions: <ul style="list-style-type: none"> <li>• AD in closed position</li> <li>• MCU K11 (AD hinge) is connected</li> <li>• AD hinge in open position</li> </ul>
c)	Send AD hinge close logic select command	MCU TM monitor indicates proper logic & MTR relay selected		
d)	Send MTR operate command	AD hinge microswitch TM monitor indicates change of status AD potentiometer indicates change of angles		Initial Conditions: <ul style="list-style-type: none"> <li>• HGA latch in open position (indicated by status microswitch monitors)</li> </ul>
3.3.2.3	Verify HGA latch assembly is functionally isolated from others	No EMI or physical interference occurs to other mechanism units		
a)	Send HGA latch open logic select command	MCU TM monitor indicates proper logic & HTH relay selected		<ul style="list-style-type: none"> <li>• HGA latch in open position (indicated by status MS TM monitors)</li> </ul>
b)	Send MTR operate command	HGA latch microswitch (drive and slave) TH monitors indicate change of status		
c)	Send HGA latch close logic select command	MCU TM monitors indicates proper logic & MTR relay		
d)	Send MTR operate command	HGA latch HS (drive & slave) 1H monitors indicate change of status (pre-loaded)		Initial Conditions: <ul style="list-style-type: none"> <li>• HGA latch in closed and latch position</li> </ul>
e)	Send HGA latch partial open logic select command	HCU TH monitors indicate proper logic & MTR relay selected		

2.3 - 83

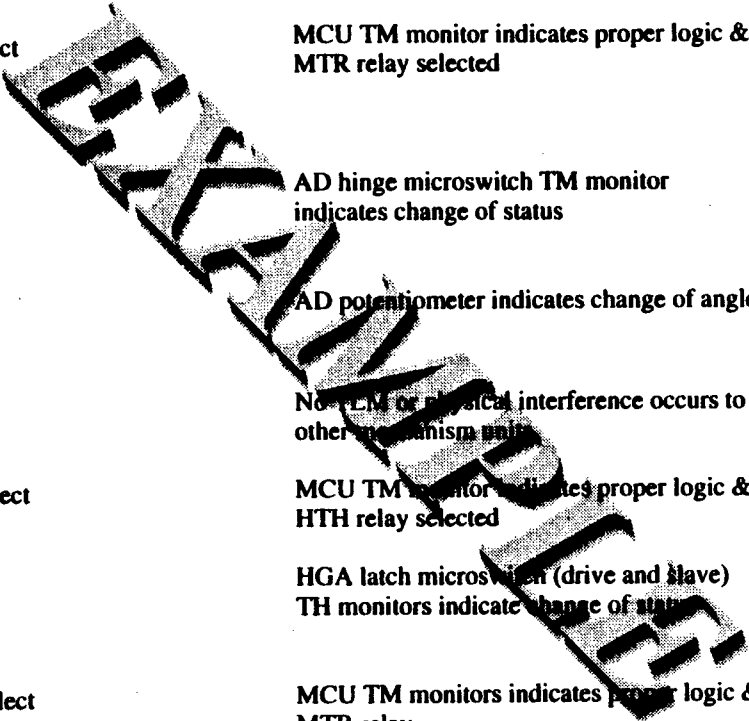

VERIFICATION REQUIREMENTS AND SPECIFICATIONS

NUMBER	REQUIREMENT STATEMENT	SIGNAL ID	CRITERIA AND SPECIFICATIONS	CONDITIONS, CONSTRAINTS, REMARKS
	f) Send MTR operate command		HGA latch MS TM monitor indicates change of status (No TM indication neither MS is depressed)	
	g) Send HGA latch partial close logic select command		MCU TM monitors indicate proper logic & MTR selected	<ul style="list-style-type: none"> <li>• HGA latch in partial open position</li> </ul>
	h) Send MTR operate command		HGA latch MS TM monitor indicates change of status (pre-loaded)	
3.3.2.4	Verify HGA hinge is functionally isolated from others		No TLM or physical interface occurs to other mechanism units or TLM	<p>Initial Conditions:</p> <ul style="list-style-type: none"> <li>• HGA hinge in stowed (down) position</li> <li>• HGA latch in close position (indicated by microswitch monitors)</li> </ul>
	a) Send HGA hinge display logic select command		MCU TM monitor indicates proper logic & MTR relay selected	
	b) Send MTR operate command		HGA hinge in up position (90 deg)	
	c) Send HGA hinge stow logic select command		MCU TM monitor indicates proper logic & MTR relay selected	<ul style="list-style-type: none"> <li>• HGA hinge in deployed (up) position</li> </ul>
	d) Send MTR operate command		HGA hinge MS TM monitors indicate change of status	
			HGA hinge in down position	
3.3.2.5	Verify SA Fwd latch is functionally isolated from others		No TLM or physical interference occurs to other mechanism units	<p>Initial Conditions:</p> <ul style="list-style-type: none"> <li>• HGA latch in partial open position</li> </ul>

2.3 - 84

EXHIBIT

VERIFICATION REQUIREMENTS AND SPECIFICATIONS

NUMBER	REQUIREMENT STATEMENT	SIGNAL ID	CRITERIA AND SPECIFICATIONS	CONDITIONS, CONSTRAINTS, REMARKS
	a) Send SA Fwd latch open logic select command		MCU TM monitors indicate proper logic & MTR relay selected	
	b) Send MTR operate command		SA Fwd latch MS TM monitors indicate change of status	
	c) Send SA Fwd latch close logic selected command		MCU TM monitors indicate proper logic & MTR relay selected	• SA Fwd latch in open position
	d) Send MTR operate command		SA Fuel latch MS TM monitors indicate proper logic & MTR relay selected	
	e) Send SA Fwd latch partial close		MCU TM monitors indicate proper logic & MTR relay selected	Initial Conditions: • SA Fwd latch in closed and latched position
	f) Send MTR operate command		SA Fwd latch MS TM monitors indicate change of status  (No TM indication - whether MS is depressed)	
	g) Send SA Fwd latch partial close		MCU TM monitor indicates proper logic & MTR relay selected	• SA Fwd latch in partial open position
	h) Send MTR operate command		Latch MS TM monitor indicates change of status (pre-loaded)	
3.3.2.6	Verify SA Aft latch is functionally isolated from others		No TLM or physical interference occurs to other mechanism units	Initial Conditions: • SA Aft latch in closed position
	a) Send SA Aft latch open logic select command		MCU TM monitor indicates proper logic & MTR relay selected	
	b) Send MTR operate command		SA Aft latch and berth MS TM monitor indicates change of status	

EXAMINED

2.3 - 85



VERIFICATION REQUIREMENTS AND SPECIFICATIONS

NUMBER	REQUIREMENT STATEMENT	SIGNAL ID	CRITERIA AND SPECIFICATIONS	CONDITIONS, CONSTRAINTS, REMARKS
	c) Send SA Aft latch close logic select ed command		MCU TM monitors indicate proper logic & HTH relay selected	• SA Aft latch in open position
	d) Send MTR operate command		SA Aft latch MS TM monitors indicate change of status (pre-loaded) Berth MS TM indicates change of status	
	e) Send SA Aft latch partial open logic select command		MCU TM monitors indicate proper logic & MTR relay selected	Initial Conditions: • SA Aft latch in closed and latched position
	f) Send MTR operate command		SA Aft latch MS TM monitors indicate change of status (pre-loaded)	
	g) Send SA Aft latch partial close logic select command		MCU TM monitors indicate proper logic & MTR relay selected	• SA Aft latch in partial open position
	h) Send MTR operate command		SA Aft latch MS TM monitors indicate change of status (pre-loaded)	
3.3.2.7	Verify MCU capable of driving two different HGA motors (one primary, one redundant) simultaneously			Initial Conditions: • MCU-A&B are powered up (only one link power supply is ON) • HGA latch in latched position CAUTION: • Do not select the primary and redundant motor of the same motor at the same time • Motor select command should consist of a primary and redundant motor of different locations
	a) Send + and - HGA latch open logic select commands		MCU TM monitors indicate proper logic & MTR relays selected	

EXAMINABLE

2.3 - 86

MSFC-HDBK-2221  
February 1994

VERIFICATION REQUIREMENTS AND SPECIFICATIONS

NUMBER	REQUIREMENT STATEMENT	SIGNAL ID	CRITERIA AND SPECIFICATIONS	CONDITIONS, CONSTRAINTS, REMARKS
	b) Send MCU A&B MTR operate command		-V1 and -V3 latch HS TH monitors indicate change of status	
	c) Send + and -V3 HGA hinge deploy logic select command		HCU TH monitors indicate proper logic & HTH relays selected	<ul style="list-style-type: none"> <li>• HGA hinge in stowed (down) position</li> </ul>
	d) Send MCU A&B MTR operate command		+V3 and -V1 hinge HS TH monitors indicate change of status	
	e) Send + and -V3 HGA hinge stow logic select command		MCU TH monitors indicate proper logic & HTH relays selected	<ul style="list-style-type: none"> <li>• Hinge is deployed (up) position</li> </ul>
	f) Send MCH A&B MTR operate command		+V3 and -V1 hinge HS TH monitors indicate change of status	
	g) Send + and -V3 HGA latch cost logic select command		MCU TH monitors indicate proper logic & HTH relays selected	<ul style="list-style-type: none"> <li>• Latch in open position</li> </ul>
	h) Send MCH A&B MTR operate command		+V3 and -V1 latch MS TM monitors indicate change of status	
3.3.2.8	Verify MCU capable of driving two different SA latch motors (one primary one redundant) simultaneously			<p>Initial Conditions:</p> <ul style="list-style-type: none"> <li>• MCU-A&amp;B are powered up (only one link power supply is ON)</li> <li>• SA latch in latched position</li> </ul> <p>CAUTION:</p> <ul style="list-style-type: none"> <li>• Do not select the primary and redundant motor of the same motor at the same time</li> <li>• Motor select command should consist of a primary and redundant motor of different locations</li> </ul>
	a) Send + and -V Fwd latch open logic select command		MCU TM monitors indicate proper logic & MTR relays selected	

2.3 - 87

VERIFICATION REQUIREMENTS AND SPECIFICATIONS

NUMBER	REQUIREMENT STATEMENT	SIGNAL ID	CRITERIA AND SPECIFICATIONS	CONDITIONS, CONSTRAINTS, REMARKS
	b) Send MCU A&B MTR operate command		+ and - V2 latch MS TM monitors indicate change of status	
	c) Send + and - V2 Aft latch open logic select command		MCU TM monitors indicate proper logic & MTR relays selected	
	d) Send MCU A&B MTR operate command		+ and - V2 Aft latch MS TM monitors indicate change of status	
3.3.2.9	Verify MCU is capable of stopping the latch/hinge motion			Initial Conditions: • HCU ON  • AD hinge in motion (closing or opening)
	a) Send the last or any MCU serial digital command (30 sec after AD is in motion)		HCU run/hold monitor goes to hold Cru monitor TH indicates motor stopped Pos monitor TH indicates AD stopped	
3.3.3	MCU CONTROLLED MECHANISMS VERIFICATION			
3.3.3.1	Verify each mechanism is functional		See Paragraph 3.3.3.2	
3.3.3.2	Verify pre-load is achieved on each mechanism			• Command to be sent from ground via DF 224 & HCU  • Switching & balancing unit, and strain indicator shall be employed for the measurement  • MSTE to be used when flight are not installed
	a) HGAs latch		850 lbf	
	b) HGAs hinge (deployed position)		80 +70/-30 in-lb	
	c) SA Fwd latch		5100 lbf	
	d) SA Aft latch		5100 lbf	
	e) AD latch		850 lbf	
	f) AD hinge (deployed position)		80 + 70/-30 in-lb	

2.3 - 88

EXAMINER

VERIFICATION REQUIREMENTS AND SPECIFICATIONS

NUMBER	REQUIREMENT STATEMENT	SIGNAL ID	CRITERIA AND SPECIFICATIONS	CONDITIONS, CONSTRAINTS, REMARKS
3.3.3.3	Verify mechanism is capable of withstanding the stall torque		<p>Note: Rotary drive is common to all mechanisms.                      HGAs latch and AD hinge are chosen arbitrary for the verification</p>	
3.3.3.3.1	<p>HGAs latch</p> <p>a) Send HGA latch close logic select command</p> <p>b) Send HGA latch activate command</p>		<p>HCU TH monitor indicate proper logic &amp; HTH relay selected</p> <p>No change in HS position when motion stopped:</p> <ul style="list-style-type: none"> <li>• Measure pre-load</li> <li>• Inspect &amp; examine mechanism and the mount</li> <li>• No damage shall occur</li> </ul>	<p>Initial Conditions:</p> <ul style="list-style-type: none"> <li>• HGAs latch in latched position</li> </ul>
	c) Repeat a and b for HGA latch in open condition		<p>When motion stopped:</p> <ul style="list-style-type: none"> <li>• Inspect &amp; examine mechanism and the mount</li> </ul>	
3.3.3.3.2	<p>AD Hinge</p> <p>a) Send AD hinge closed</p> <p>b) Send MTR operate command</p>		<p>MCU TH monitor indicate</p> <p>No change in MS position when motion stopped:</p> <ul style="list-style-type: none"> <li>• measure pre-load</li> <li>• inspect and examine mechanism and the mount</li> <li>• No damage shall occur</li> </ul>	<p>Initial Conditions:</p> <ul style="list-style-type: none"> <li>• AD in closed and latched position</li> </ul>

2.3 - 89

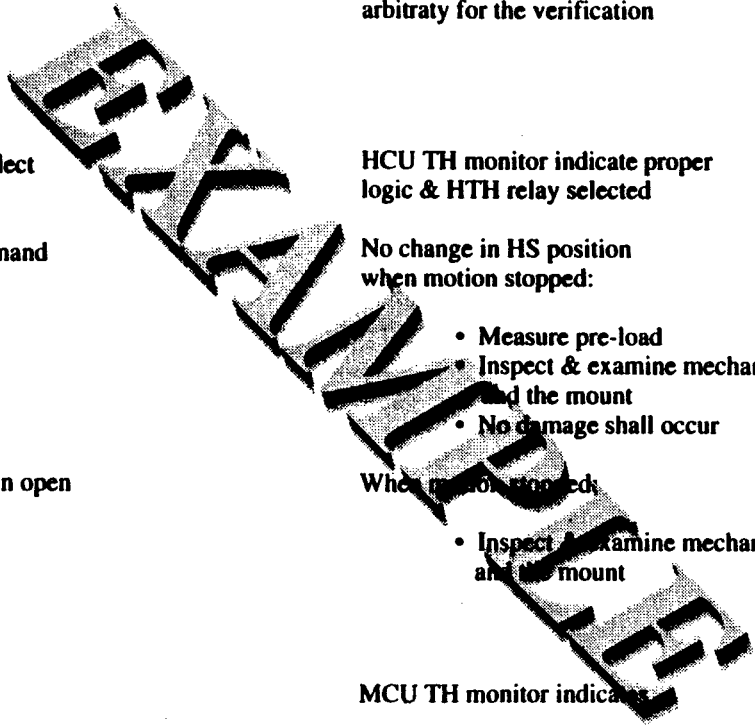

VERIFICATION REQUIREMENTS AND SPECIFICATIONS

NUMBER	REQUIREMENT STATEMENT	SIGNAL ID	CRITERIA AND SPECIFICATIONS	CONDITIONS, CONSTRAINTS, REMARKS
3.3.4	MCU/P SEA I/F FUNCTIONAL TEST			
3.3.4.1	Verify MCU capable of closing the AD when the sun (simulated) is within 3 deg. field of view		Within 1 minute AD hinge TM motor indicates closed	Initial Conditions: <ul style="list-style-type: none"> <li>• AD hinge in open condition</li> <li>• MCU register loaded with proper logic</li> </ul>
3.3.4.2	Verify MCU capable of closing AD when safe mode signal is received from the PSEA		Within 1 minute AD hinge TM motor indicates closed  Potentiometer TM monitor indicates door position	Initial Conditions: <ul style="list-style-type: none"> <li>• AD hinge in open condition</li> <li>• MCU register loaded with proper logic</li> </ul>
3.3.5	TWO AXIS GIMBAL (TAG) SIMULATOR AND GIMBAL ELECTRONICS-ASSY (GEA) COMPATIBILITY TEST			Initial Conditions: <ul style="list-style-type: none"> <li>• On board computer shall be used for command process</li> <li>• GEA 1 &amp;2 installed</li> <li>• Tag simulator to be used</li> </ul>
3.3.5.1	Verify GEA-1 turns ON/OFF in response to command		GEA TM monitors indicate ON/OFF	Initial Conditions: <ul style="list-style-type: none"> <li>• GEA-1 in OFF state</li> <li>• GEA-2 in OFF state</li> </ul>
3.3.5.2	Verify GEA-2 turns ON/OFF in response to command		GEA TM monitors indicate ON/OFF  GEA 1/2 temp TM monitor reads 0 volt	
3.3.5.3	Verify cross strap between GEA-1 and TAG a. GEA-1 and + TAG X axis b. GEA-1 and -TAG X axis c. GEA-1 and +TAG Y axis d. GEA-1 and - TAG Y axis		GEA TM monitors indicate connected	
3.3.5.4	Verify cross strap between GEA-1 and TAG a. GEA-2 and + TAG X axis b. GEA-2 and -TAG X axis c. GEA-2 and +TAG Y axis d. GEA-2 and - TAG Y axis			

EXAMINER

2.3 - 90

VERIFICATION REQUIREMENTS AND SPECIFICATIONS

NUMBER	REQUIREMENT STATEMENT	SIGNAL ID	CRITERIA AND SPECIFICATIONS	CONDITIONS, CONSTRAINTS, REMARKS
3.3.5.5	Verify GEA (1 &2) over temp lockout capability			Initial Conditions: <ul style="list-style-type: none"> <li>• TAG simulator in high temp mode</li> <li>• GEA bridge latch engaged</li> </ul>
	a) Send GEA bridge latch override command		GEA monitor indicates no change	NOTE: TAG simulator in use
	b) Send GEA HGA torque command (arbitrary) or DF-224 generated command		GEA lockout, signal no processed	
	c) Send GEA bridge latch override command		GEA TM monitor indicates latch disengaged	
	d) Send GEA HGA torque command (arbitrary) or DF-224 command		GEA TM monitors indicate change of state	
3.3.5.6	Verify GEA (1 &2) undervolt lockout capability			Initial Conditions: <ul style="list-style-type: none"> <li>• TAG simulator in normal temp mode</li> </ul>
	a) Simulate undervoltage condition		GEA bridge latch engages	
	b) Send GEA HGA torque command		GEA lockout, signal	
	c) Simulate normal volt condition		GEA bridge latch	
	d) Send GEA HGA torque command (arbitrary) or DF-224 generated command		GEA TM monitors indicate change of state	<ul style="list-style-type: none"> <li>• TAG simulator in normal temp mode</li> </ul>
3.3.5.7	Verify GEA overtemp and under volt cap are independent			Initial Conditions: <ul style="list-style-type: none"> <li>• TAG simulator in normal temp mode</li> <li>• Undervolt condition exists</li> <li>• GEA bridge latch engaged</li> </ul>
	a) Send bridge latch override command		GEA bridge latch in disengage position (no change)	
	b) Send GEA HGA torque command (arbitrary) or DF-224 generated command		Signal not processed	

2.3 - 91

EXAMINER

VERIFICATION REQUIREMENTS AND SPECIFICATIONS

NUMBER	REQUIREMENT STATEMENT	SIGNAL ID	CRITERIA AND SPECIFICATIONS	CONDITIONS, CONSTRAINTS, REMARKS
3.3.5.8	<p>Verify GEA &amp; TAG compatibility via the on board computer</p> <p>a) Send GEA sin initial command</p> <p>b) Send GEA gimbal slew command</p> <p>c) Send gimbal ID command</p> <p>d) Send maneuver duration command</p> <p>e) Send final measured angle command</p> <p>f) Send update of init angle command</p>		<p>Each GEA &amp; TAG combination and cmd functions shall be verified</p>	<p>The following serial digital commands are instructions to the DF-224 for control of the TAG</p>
3.3.5.9	<p>Verify GEA &amp; TAG compatibility via the computer bypass mode</p> <p>a) Send GEA HGA torque command</p> <p>b) Send GEA HGA reverse torque command (to stop the motion)</p>		<p>Each GEA &amp; TAG combination and cmd functions shall be verified</p>	<p>The following serial digital commands are real time commands use to torque the TAG via the DIU</p>
3.3.6	<p>TWO AXIS GIMBAL (TAG) AND GEA FUNCTIONAL TEST</p>		<p>Repeat para 13.3.5.1 to 3.3.5.4</p>	<p>Initial Conditions</p> <ul style="list-style-type: none"> <li>• Flight TAG &amp; GEA to be used</li> <li>• TAG mass to be zero g'ed</li> <li>• HGA dish to be removed</li> <li>• Normal configuration:                             <ul style="list-style-type: none"> <li>+V3 Axis</li> <li>X TAG @ 0 deg</li> <li>X TAG @ -90 deg</li> <li>-V3 Axis</li> <li>Y TAG @ 0 deg</li> <li>Y TAG @ -90 deg</li> </ul> </li> </ul>
3.3.6.1	<p>Verify TAG &amp; GEA cross stripping I/F</p>		<p>Repeat para 13.3.5.1 to 3.3.5.4</p>	

2.3 - 92

EXAMINER

VERIFICATION REQUIREMENTS AND SPECIFICATIONS

NUMBER	REQUIREMENT STATEMENT	SIGNAL ID	CRITERIA AND SPECIFICATIONS	CONDITIONS, CONSTRAINTS, REMARKS
3.3.6.2	Verify TAG & GEA compatibility via the on-board computer			
	a) Send serial digital cmds to +V3 X TAG		1) TAG travels from a known position (arbitrary) to +100 deg 2) From +100 to -100 deg 3) From -100 to normal position	
	b) Send serial digital cmds to +V3 Y TAG		1) TAG travels from a known position (arbitrary) to +100 deg 2) From +100 to -100 deg 3) From -100 to normal position	
	c) Repeat above a) & b) for -V3 axis			
3.3.6.3	Verify TAG & GEA compatibility via the computer bypass mode			
	a) Send GEA TAG torque command to +V3 X TAG (-10 deg arbitrary)		TAG travels about 10 deg	
	b) Send GEA TAG torque command to +V3 X TAG (-10 deg for stopping)		TAG gradually stops with 10 degs delta	
	c) Send GEA DGA torque command to +V3 Y TAG (-10 deg arbitrary)		TAG travels about 10 deg	
	d) Send GEA GDA torque command to +V3 Y TAG (-10 deg for stopping)		TAG gradually stops with 10 degs delta	
	e) Repeat above a) & b) for -V3 axis			
3.3.7	MECHANICAL CONTINUITY TESTS			
3.3.7.1	Verify GE/TAG electrical continuity			
	a) Send GEA DGA torque command to (2 oz-in) to +V3 X TAG		STE monitors verify command execution via TAG test plug	

2.3 - 93

EXAMINED



VERIFICATION REQUIREMENTS AND SPECIFICATIONS

NUMBER	REQUIREMENT STATEMENT	SIGNAL ID	CRITERIA AND SPECIFICATIONS	CONDITIONS, CONSTRAINTS, REMARKS
	<p>b) Send GEA DGA torque command to (2 oz-in) to +V3 Y TAG</p> <p>C) Repeat above a) and b) for -V3 axis</p>		STE monitors verify command execution via TAG test plug	<p>Initial Conditions:</p> <ul style="list-style-type: none"> <li>• Flight HGAs (dish, TAG mast &amp; GEA) installed and latched</li> <li>• Vehicle powered up</li> <li>• TAG test plug shall be used</li> <li>• Vehicle powered up</li> <li>• TAG test plug shall be used</li> </ul>
3.3.7.2	<p>Verify S/A electrical continuity</p> <p>a) PDM</p> <p>b) SDM</p> <p>c) Diode Box</p>		STE monitors indicate continuity	<p>Initial Conditions:</p> <ul style="list-style-type: none"> <li>• Flight SA installed and latched</li> <li>• Vehicle powered up</li> <li>• SA test plugs shall be used</li> <li>• Break out box shall be used</li> </ul>
3.3.8	SERVICE LOOP I/F TEST			<p>Initial Conditions:</p> <ul style="list-style-type: none"> <li>• Flight appendages installed</li> </ul>
3.3.8.1	Verify AD hinge harness service loop		<p>Inspection</p> <p>No binding exists</p>	
3.3.8.2	Verify HGA hinge harness service loop		<p>Inspection</p> <p>No binding exists</p>	
3.3.8.3	Verify SA harness service loop		<p>Inspection</p> <p>No binding exists</p>	
3.3.8.4	Verify SA harness service loop		<p>Inspection</p> <p>No binding exists</p>	

2.3 - 94

EXAMINABLE

VERIFICATION REQUIREMENTS AND SPECIFICATIONS

NUMBER	REQUIREMENT STATEMENT	SIGNAL ID	CRITERIA AND SPECIFICATIONS	CONDITIONS, CONSTRAINTS, REMARKS
3.3.9	APPENDAGES DEPLOYMENT TESTS			<p>Initial Conditions:</p> <ul style="list-style-type: none"> <li>• Flight appendages installed and to be used for the test</li> <li>• Aperture door mass to be zero G'd during test</li> <li>• All commands via the on board computer except during AD deployment test</li> <li>• AD latch in closed/latched position</li> <li>• ST in horizontal attitude -V3 up</li> <li>• AD in open position</li> </ul>
	a) Send AD unlatched command		AD latch to unlatch	
	b) Send AD open command		AD travels to open position (105 deg)	
	c) Send AD close command		AD travels to closed position	
	d) Send AD latch command		AD latch to latch	
3.3.9.2	HGAs Deployment Test (perform for both HGA)			<ul style="list-style-type: none"> <li>• HGA latch in stowed and latched position</li> <li>• MCU loaded w/proper logic</li> <li>• HGA mast and TAG to be restrained/strongbacked</li> <li>• The ST shall be vertical (+VI UP)</li> <li>• HGA mast restrained</li> <li>• MCU loaded w/proper logic</li> </ul>
	a) Send HGA unlatched command		TM indicates unlatch	
	b) Send HGA deployment command		TM indicates change	
	c) Send HGA retract command (500 steps)		TM indicates change of status	
	d) Send HGA latch command		TM indicates latched	

2.3 - 95

EXAMINABLE

## 5.0 ELECTRICAL POWER SUBSYSTEM INTERFACES

### 5.1 INTRODUCTION AND GENERAL REQUIREMENTS

5.1.1 Scope. This section contains the verification requirements of the Electrical Power Subsystem (EPS) interfaces.

The EPS Safe Mode design feature will be verified as specified in the Safing System section. This includes the Safe Mode to SA system interface.

5.1.2 Subsystem Description. The EPS provides the electrical power generation, storage, conditioning, control, regulation, distribution and circuit protection.

For normal orbital operations, the EPS receives power from the SA wings to maintain the batteries charged and supplies power to all users. From the time of payload closeout at KSC until the Orbiter via the EPS to the required equipment.

The EPS is specified to provide a maximum orbital average power of 1250 Watts at interfaces for 2 years, with one battery failed, when provided with specified SA power. The EPS is designed to maintain a normal or power positive configuration in the various safe modes. The following are functional components of the EPS.

#### 5.1.2.1 Power Control Unit (PCU).

- The PCU receives, controls and distributes power from 18 of the 20 SA wing panels to the 6 battery Charge Current Control (CCC) relay circuits. Two panels are normally connected directly to the Diode Bus.
- PCU contains 6 separate relay circuits (one for each CCC/battery) controlled by the CCC or bypassed by command. These circuits provide SA power to the 6 batteries or directly to the battery bus.
- PCU provides fused EPS instrumentation and transfer switch control buses powered from the battery bus.
- PCU provides a single point ground to structure for the EPS buses.

- PCU contains 6 battery discharge/conditioning control circuit providing for a controlled battery discharge at two different rates.
- PCU contains 3 redundant Main power buses supplied from 3 diode buses. Each Main bus is provided with ON/OFF control. The 3 diode buses are supplied from either the 6 batteries or directly from CCC circuits (bypassing the battery during conditioning or failure).
- PCU contains 3 redundant essential buses powered directly from 3 diode buses. These buses supply continuous power to equipment required for ascent and critical Safe Mode functions (MA receivers, DMS CDI, FHST Shutter Motors). Essential bus power can only be removed by the Orbiter Crew via the umbilical or via the Astronaut Control Panel.
- PCU provides circuit protection (fuses) from the 3 main power buses to 4 separate Power Distribution Units (PDU) where the power is distributed to power users.
- PCU provides a power interface with the Orbiter. Orbiter power is supplied to the 3 essential buses and/or the 2 main buses by manual command from the crew.
- PCU provides power control interface with the Orbiter Crew via the Astronaut Control Panel. Manual Commands are provided to control internal main and essential bus power to aid in Orbital Maintenance.
- PCU provides a GSE/STE interface via the EPS test plug accessible for Systems test. Power OFF control is provided. Battery charge and discharge can be accomplished through the EPS test plug (with battery voltage and temperature monitors provided). The EPS test plug also provides for power bus monitoring, test points used for bus resistance tests and during application of power, and power user control (PDU relay resets).

**5.1.2.2 Power Distribution Units (PDU).** There are 4 separate PDUs. The purpose of the PDU is to sum ("or") power received from PDU through main buses. Internal power controls is not provided; provide power status of each equipment; and distribute power to users.

5.1.2.3 Change Current Controllers (CCC). There are 6 CCCs, one for each of the 6 batteries. The CCC provides the capability to charge the battery. Each battery circuit is supplied by SA power derived from 3 SA panels. The CCC control relays are located in the PCU. The CCC monitors the battery voltage and temperature and connects/disconnects the control relays in the PCU depending on predetermined battery voltage and temperature characteristics. Four sets of battery characteristics are selectable by command. The purpose of the CCC and SA control relays is to balance the SA output with the vehicle load such that the battery compliment is fully charged just prior to entering the Earth's shadow.

5.1.2.4 Batteries. There are 6 EPS batteries that interface to the PCU battery buses and CCC control relay and battery discharge/conditioning circuits. The batteries are rechargeable nickel-cadmium, each having a capacity of 57 ampere-hours. The purpose of the batteries is to supply power during deployment, and to supply orbital power during operations in the Earth's shadow, during high current surges, or for off-nominal roll SA orientation.

5.1.2.5 Solar Arrays (SA). The SA wings and mechanisms, Deployment Control Electronics (DCE), and two Solar Array Drive Electronics (SADE) are included in the SSM EPS Subsystem. The SA is rated at 4,000 Watts output at 34 volts after two years in orbit. The SA deployment mechanisms interface via an adapter to the SA drive (orientation) mechanism. The SA deployment and wing unfurling mechanisms are controlled by the DCE, which also conditions SA performance monitors to the DMS. The SA drive mechanism is controlled by the two SADEs.

5.1.5 General Requirements. For all verifications performed under authority of this document, the following general requirements, guidelines and ground-rules, as applies to the EPS, shall be in effect.

5.1.5.1 EPS Test Configuration. The EPS subsystem shall be completely assembled and interconnected with SSM flight hardware, with the following exceptions:

- a. The flight batteries (6) will not be installed in the SSM Equipment Section. The SSM flight batteries will be installed just prior to leaving the VPF at the launch base.
- b. The flight SA wings will not be installed or connected to the SSM until the test. A development model SA wing will be available during SSM assembly, but will be used only for mechanical fit and latch interface verification tests. A SA wing simulator will be connected to the SSM, simulating all wing functions except power input.

- c. The GSE/STE SA wing simulator and GSE SA power simulated input shall be connected directly to the SA diode box interfaces.

5.1.5.5 SA Wing Function. The SADE Unit Tester and SIVS are required to verify both the interfaces and the SA electronic boxes (DCE, SADE).

The SA wing deployment, orientation and monitor functions specified herein shall be simulated by the SIVS for all automated systems tests at STAVF.

5.1.5.6 Verification Requirements. The general verification requirements are as follows.

#### SA Wings Disconnected

- a. Verify SA power continuity (at nominal current) from both primary and redundant SA panel inputs through SA diode box, PCU and return to proper SA panel source. Verify for each systems test at STAVF (GSE SA power inputs connected)
- b. Verify the SA primary and redundant power inputs are isolated (SA diode box diode isolation). Verify for the first and final ambient systems tests at STAVF only.

#### SA Wings Connected

- A continuity test shall be performed after the SA wings are connected to verify the interface. As a minimum, continuity tests shall be performed after initial SA wing connection, for pre and post-acoustic exposure and after final connection of SA wings at STAVF and KSC. The following functions shall be verified.
- SA power input to SA diode boxes (primary and redundant) for each 20 panel inputs and returns. Continuity tests (Dark Current tests) shall be performed by use of the diode box EVA interface connectors.
- Primary Deployment Mechanism (PDM) main and redundant motor coils (phases 1 and 2 and returns) for both wings. DCE test plug access is required.
- Secondary Deployment Mechanism (SDM) main and redundant motor coils (power and return) for both wings. DCE test plug access is required.

- SAD main and redundant motor coils (phases 1 and 2 and returns) for both wings. SADE 1 and 2 test plug access is required.
- SA temperature and strain gage telemetry (observe ambient, non-zero output or stimulate sensor, as required to cause and output TBD).
- SA main and redundant deployment micro-switch telemetry (observe non-zero output or stimulate sensor, as required to cause an output TBD).
- SA orientation resolver signals (sine and cosine) to each SADE 1 and 2. SADE 1 and 2 test plug access is required. Verify resolver telemetry output in stowed position.

#### 5.1.5.6 Verification Requirements (Continued)

##### SA Wings Connected (Continued)

- a. Continuity to PDM, SDM, and diode box heater circuits. Diode box test plug access is required.
- b. Deleted
- c. Interchangeability of the SA wings shall be demonstrated utilizing the SA Development wing in both SA wing positions.

5.1.5.7 Verification of Primary and Redundant Power Supplies. The separate and isolated verification of primary and redundant power supplied to an individual user (box or module level) requires that verification of these functions take place with, first, one supply powered (primary or redundant) and the other not powered, followed by the same verifications performed with the previously powered and unpowered sides reversed.

5.1.5.8 Bus Isolation Checks. Bus isolation checks of buses ganged together in a single connector require that only the bus being checked be powered, the rest being powered off.

VERIFICATION REQUIREMENTS AND SPECIFICATIONS

NUMBER	REQUIREMENT STATEMENT	SIGNAL ID	CRITERIA AND SPECIFICATIONS	CONDITIONS, CONSTRAINTS, REMARKS
5.2	ELECTRICAL POWER SOLAR ARRAY INTERFACE VERIFICATION BY TEST			
5.2.1	SOLAR ARRAY (SA) POWER INPUT AND SA/PCU INTERFACE			
5.2.1.1	Verify SA trim relays (Figure 5.2-1) disconnect (isolate) associated SA power inputs from CCC control circuit in response to SA trim relay OPEN command		Appropriate SA trim relay position TM monitor indicates - Open (all others remain closed)	<p>Initial Conditions:</p> <ul style="list-style-type: none"> <li>All SA trim relays - Closed (20 ea)</li> <li>Simulated SA power applied to SA trim relay circuit being tested and removed (Off) from all other SA trim relay circuits.</li> <li>Minimum of 1 amps supplied through SA trim relay circuit being tested by conditioning associated diode bus loads, as required.</li> <li>CCC control or bypass relays associated with SA trim relay circuit being tested - closed.</li> </ul>
5.2.1.2	<p>Verify the following in response to SA trim CLOSE command (Figure 5.2-1)</p> <p>a. SA trim relays connect associated SA power inputs to CCC control circuits.</p> <p>b. Continuity and proper return from SA power inputs ( 36 ea) through SA trim relays to CCC Control Circuits</p> <p>c. Continuity and proper return from SA power inputs (3 ea) through SA trim relays to Diode Buses</p>		<p>Appropriate SA trim relay position TM monitor indicates - Closed (all others indicate OPEN)</p> <p>SA current TM monitor indicate minimum of 1 amp increase in current.</p>	<p>Initial Conditions:</p> <ul style="list-style-type: none"> <li>All SA trim relays (20 ea) - Open except for K74 &amp; K75 relays which are connected to SA return (Figure 5.2-1)</li> <li>Simulated SA power applied to SA trim relay circuit being tested and removed (Off) from all other SA trim relay circuits.</li> <li>Condition associated diode bus loads, as required, to provide a minimum of 1 amp load upon receipt of SA trim relay CLOSE command.</li> </ul>

EXAMINABLE

NSFC-110-08-221  
 1  
 1994



VERIFICATION REQUIREMENTS AND SPECIFICATIONS

NUMBER	REQUIREMENT STATEMENT	SIGNAL ID	CRITERIA AND SPECIFICATIONS	CONDITIONS, CONSTRAINTS, REMARKS
5.2.2	CHARGE CURRENT CONTROL (CCC) AND CCC/PCU INTERFACE			<ul style="list-style-type: none"> <li>• CCC control associated with SA trim relay being tested - Closed</li> <li>• CCC bypass relays opened</li> </ul>
5.2.2.1	CCC on/off functions			
5.2.2.1.1	Verify CCC units (Figure 5.2-1) Turn ON in response to command		<p>CCC ON ( K1/K2 Cont. Level Monitors)</p> <p>CCC control relay position monitors TM indicate proper status based on battery temperature and voltage (see Figure 5.2-1)</p>	<p>Initial Conditions:</p> <ul style="list-style-type: none"> <li>• CCC power OFF</li> <li>• CCC bypass relays open</li> </ul>
5.2.2.1.2	Verify CCC units (Figure 5.2-1) Turn OFF and de-energize associated CCC control relays in response to command		<p>CCC OFF ( K1/K2 Cont. Level Monitors)</p> <p>CCC control relay position monitors TM indicate de-energized (closed)</p>	<p>Initial Conditions:</p> <ul style="list-style-type: none"> <li>• CCC power ON</li> <li>• both CCC control relays associated with CCC being tested energized/open (Figure 5.2-1)</li> </ul>
5.2.2.3	Effect of battery temperature on CCC operation			
5.2.2.3.1	Verify that the CCC control relays energize (Open) within the battery temperature and terminal voltage limits specified			<p>Verify for both CCC control relays See Table 5.2-3 for battery temperature simulator resistor values.</p>
	a. Verify at ambient battery temperature as a result of increasing battery terminal voltage (battery charge)		<p>CCC control relay position TM monitors indicate open (energized) at the proper battery temperature and terminal voltage as indicated on Table 5.2-3</p>	<p>Initial Conditions:</p> <ul style="list-style-type: none"> <li>• Battery terminal voltage conditioned, as required, to affect CCC control relay de-energize (close) function</li> </ul>

2.3 - 102

EXAMINER

VERIFICATION REQUIREMENTS AND SPECIFICATIONS

NUMBER	REQUIREMENT STATEMENT	SIGNAL ID	CRITERIA AND SPECIFICATIONS	CONDITIONS, CONSTRAINTS, REMARKS
5.2.2.3.2	b. Verify for battery temperatures of 40 deg F and 70 deg F as a result of increasing battery terminal voltage (simulated)			<ul style="list-style-type: none"> <li>• CCC bypass relays open (Figure 5.2-1)</li> <li>• SA trim relays (2 ea) associated with CC control relay circuit being tested-Closed (Figure 5.2-1)</li> <li>• Battery/Diode has relay in the battery position</li> </ul> Initial Conditions: <ul style="list-style-type: none"> <li>• CCC control relay Closed/de-energized (Figure 5.2-1) battery temperature and terminal voltage simulator connected to battery connectors</li> </ul>
	Verify that the CCC control relays (Figure 5.2-1) de-energize (Close) within the battery temperature and terminal voltage limits specified		CCC control relay position TM monitors indicate open (energized) at the proper battery temperature and terminal voltage as indicated on Table 5.2	Initial Conditions: <ul style="list-style-type: none"> <li>• Battery terminal voltage conditioned, as required, to affect CCC control relay energized (Open) function</li> <li>• CCC bypass relays open</li> <li>• SA trim relays associated with CCC control relay circuit being tested</li> <li>• Battery/Diode has relay in the battery position</li> </ul>

EXAMINER

VERIFICATION REQUIREMENTS AND SPECIFICATIONS

NUMBER	REQUIREMENT STATEMENT	SIGNAL ID	CRITERIA AND SPECIFICATIONS	CONDITIONS, CONSTRAINTS, REMARKS
5.2.2.3.3	b. Verify for battery temperatures of 40 deg F and 70 deg F as a result of decreasing battery terminal voltage (simulated)		CCC control relay position TM monitor indicates closed (re-energized) at the proper simulated battery terminal voltage for simulated battery temperatures of 40 deg F and 70 deg F as indicated on Table 5.2-3.	Initial Conditions: <ul style="list-style-type: none"> <li>• CCC control relays open/energized</li> <li>• Battery temperature and terminal voltage simulator connected to the associated battery connector</li> </ul>
	Verify that the CCC control relays energize (Open) at the specified battery over-temperature conditions			
5.2.2.3.4	a. Verify relays K12, K22, K34, K42, K52 by increasing battery temperature (simulated)		CCC control relay position TM monitors indicate open (energized) at 65 deg F battery temperature (2480 ± 5 ohms)	Initial Conditions: <ul style="list-style-type: none"> <li>• Battery temperature and terminal voltage simulator connected to the associated battery connector</li> <li>• CCC control relay de-energized by adjusting the simulated battery terminal voltage to 28 ± 1 volts and temperature below 40 deg F.</li> </ul>
	b. Verify relays K11, K21, K31, K41, K51, and K61 by increasing battery temperature (simulated)		CCC control relay position TM monitors indicate open (energized) at 40 deg F battery temperature (2200 ± 5 ohms)	Initial Conditions: <p>Same as a. above except adjust the simulated battery voltage to 28 ± 1 volts and temperature below 40 deg F.</p>
5.2.2.3.4	Verify that the CCC control relays (Table 5.2-1) de-energize (Close) at the specified battery temperature conditions following an over-temperature condition			

2.3 - 104

VERIFICATION REQUIREMENTS AND SPECIFICATIONS

NUMBER	REQUIREMENT STATEMENT	SIGNAL ID	CRITERIA AND SPECIFICATIONS	CONDITIONS, CONSTRAINTS, REMARKS
	a. Verify relays K12, K22, K32, K42, K52, and K62 by decreasing battery temperature (simulated)		CCC control relay position TM monitors indicate close (de-energized) at 70 deg F battery temperature (3650 ± 5 ohms)	
	b. Verify relays K11, K21, K31, K41, K51, and K61 by decreasing battery temperature (simulated)		CCC control relay position TM monitors indicate close (de-energized) at 75 deg F battery temperature (3150 ± 5 ohms)	
5.2.2.4	CCC bypass relay OPEN/CLOSE			Initial Conditions:
5.2.2.4.1	Verify CCC bypass relays (Figure 5.2-1) close in response to appropriate bypass relay Close command		CCC bypass relay position TM indicated closed	<ul style="list-style-type: none"> <li>Battery terminal voltage conditioned as required to energize (Open) the CCC control relay is parallel with CCC bypass relay being tested.</li> <li>CCC bypass relays open</li> <li>SA trim relays associated with CCC bypass relay being tested - Closed</li> <li>Battery/Diode bus relay in the battery position</li> </ul>
5.2.2.4.2	Verify CCC bypass relays open in response to appropriate bypass relay Open command		CCC bypass relay position TM indicated open	<p>Initial Conditions:</p> <ul style="list-style-type: none"> <li>Battery terminal voltage conditioned as required to energize (Open) the CCC control relay is parallel with CCC bypass relay being tested.</li> <li>CCC bypass relays closed</li> <li>SA trim relays associated with CCC bypass relay being tested - Closed</li> <li>Battery/Diode bus relay in the battery position</li> </ul>

MSFC-HDBK-221  
February 1994

VERIFICATION REQUIREMENTS AND SPECIFICATIONS

NUMBER	REQUIREMENT STATEMENT	SIGNAL ID	CRITERIA AND SPECIFICATIONS	CONDITIONS, CONSTRAINTS, REMARKS
5.2.3	BATTERY AND BATTERY/PCU INTERFACE			
5.2.3.1	Battery charging using SA input and CCC controls			
5.2.3.1.1	Verify battery charging capability using SA input interface and CCC control circuit		Battery fully charged per KFS 220	Initial Conditions:
	Monitor SA and battery current sensors	C361A C362A C363A C364A C365A C366A C321A C322A C323A C324A C325A C320A	Verify the SA and battery current sensors read within 5 percent of the OSE current monitors	<ul style="list-style-type: none"> <li>The battery loss shall be disconnected and CCCs powered and the CCC relay bypass off</li> </ul>
5.2.3.2	Battery/Diode Bus relay operation			
5.2.3.2.1	Verify battery/diode bus relays (Figure 5.2-1) connect CCC control relay circuits to appropriate battery and Diode bus and disables battery discharge in response to the commands		Battery/Diode bus relay position TM monitor in battery position	<p><b>Constraints.</b> Battery/Diode bus relays shall not be switched with more than 25 amps load present.</p> <p>Initial Conditions:</p> <ul style="list-style-type: none"> <li>Battery/Diode bus relay is in the Diode bus position</li> <li>Battery high and low discharge rate OFF</li> </ul>
	Send either high or low rate battery discharge		Monitor battery bus current verify no discharge current	

2.3 - 106

MSFC-HDBK-2221  
February 1994

VERIFICATION REQUIREMENTS AND SPECIFICATIONS

NUMBER	REQUIREMENT STATEMENT	SIGNAL ID	CRITERIA AND SPECIFICATIONS	CONDITIONS, CONSTRAINTS, REMARKS
5.2.3.2.2	Verify battery/diode bus relays (Figure 5.2-1) connect CCC control relay circuits from associated Diode bus and enables battery discharge in response to the following commands (Table 5.2-1)	Monitor battery bus current to verify discharge current	Send either high or low rate battery discharge command	<p><b>Constraints.</b> Battery/Diode bus relays shall not be switched with more than 25 amps load present. The appropriate SA trim relays shall be opened prior to switching</p> <ul style="list-style-type: none"> <li>Battery terminal voltage conditioned, as required, to affect CCC control relay de-energized (closed) function (Table 5.2-1)</li> </ul>
5.2.3.2.3	Verify battery/diode bus relays (Figure 5.2-1) connect CCC control relay circuits to associated Diode bus (disconnected from battery) , and 2) disconnects CCC control relay circuits from associated diode bus (connected to battery) by performing the following sequence	Battery/Diode bus relay position TM monitor in the Diode bus position	a. Send SA Section to Diode bus command - DDD control relays to Diode bus, disconnect from battery	<p><b>Constraints.</b> Battery/Diode bus relays shall not be switched with more than 25 amps load present. The appropriate SA trim relays shall be opened prior to switching</p> <ul style="list-style-type: none"> <li>Battery terminal voltage conditioned, as required, to affect CCC control relay de-energized (closed) function (Table 5.2-1)</li> </ul>
	b. Send commands to close SA trim relays associated with battery circuit being tested	Diode bus voltage TM monitor indicates an increase in voltage		<p><b>Initial Conditions:</b></p> <ul style="list-style-type: none"> <li>Battery/Diode bus relay in the battery position</li> <li>SA trim relays (3 ea) associated with battery current being tested - open</li> </ul>
	c. Send commands to open SA trim relays associated with battery circuit being tested	SA trim relay position TM monitor indicates closed		<ul style="list-style-type: none"> <li>CCC control or bypass relays associated with battery circuit being tested - closed</li> </ul>
		Diode bus voltage TM monitor decreases to low level as in initial conditions		<ul style="list-style-type: none"> <li>Loads and power sources connected to the diode bus to which the CCC control relays are to be switched shall be such that a positive voltage drop will occur on Diode bus concurrent with closing of SA trim relays</li> </ul>
		SA trim relay position TM monitor indicates open		

EXPIRED

2.3 - 107

MSFC-HDRK-221  
1994

VERIFICATION REQUIREMENTS AND SPECIFICATIONS

NUMBER	REQUIREMENT STATEMENT	SIGNAL ID	CRITERIA AND SPECIFICATIONS	CONDITIONS, CONSTRAINTS, REMARKS
	d. Send battery charge ON command - CCC control relays to better, disconnect from Diode bus		Battery Diode bus relay position TM monitor in the pattery position.  Diode bus voltage TM monitor does not change (disconnected)	
	e. Send commands to close SA trim relays associated with battery circuit being tested		SA trim relay position TM monitor indicates closed	
5.2.3.3	Battery discharge ON/OFF			
5.2.3.3.1	Verify battery high rate discharge ON (Figure 5.2-1) by commanding high rate battery discharge ON.		Battery high rate discharge TM monitor indicates discharge  Battery charge/discharge current. TM monitor indicates 5.7 ± .7 amp discharge	<u>Constraint.</u> Do not allow battery terminal voltage to decrease below 26.5 Volts  Initial Conditions: <ul style="list-style-type: none"> <li>• Battery discharge off</li> <li>• SA to Battery/Diode bus relay in the Diode Bus position (Table 5.2-1)</li> <li>• Battery terminal voltage a minimum of 28 volts</li> </ul>
5.2.3.3.2	Verify battery high rate discharge OFF (Figure 5.2-1) by commanding battery discharge OFF.		Battery high rate discharge TM monitor indicates discharge OFF  Battery current TM monitor indicates 0 amps (discharge off)	Initial Conditions: <ul style="list-style-type: none"> <li>• Battery high rate discharge on</li> <li>• Battery low rate discharge off</li> <li>• Battery/Diode bus relay in the Diode Bus position</li> <li>• Battery terminal voltage between 26.5 and 32.5 volts</li> </ul>

EXAMINER

VERIFICATION REQUIREMENTS AND SPECIFICATIONS

NUMBER	REQUIREMENT STATEMENT	SIGNAL ID	CRITERIA AND SPECIFICATIONS	CONDITIONS, CONSTRAINTS, REMARKS
5.2.3.3.3	Verify battery low rate discharge ON (Figure 5.2-1) by commanding low rate battery discharge ON.	ID	<p>Battery low rate discharge TM monitor indicates discharge OFF</p> <p>Battery charge/discharge current TM monitor indicates <math>.50 \pm .08</math> discharge rate</p>	<p><b>Constraint.</b> Do not allow battery terminal voltage to decrease below 26.5 Volts</p> <p>Initial Conditions:</p> <ul style="list-style-type: none"> <li>• Battery discharge off</li> <li>• Battery/Diode bus relay in the Diode Bus position</li> <li>• Battery terminal voltage a minimum of 28 volts</li> </ul>
5.2.3.3.4	Verify battery discharge OFF (Figure 5.2-1) by commanding battery discharge OFF.	ID	<p>Battery low rate discharge TM monitor indicates discharge OFF</p> <p>Battery charge/discharge current TM monitor indicates 0 amps (discharge off)</p>	<p>Initial Conditions:</p> <ul style="list-style-type: none"> <li>• Battery low rate discharge on (one-half AMP discharge rate)</li> <li>• Battery high rate discharge off</li> <li>• Battery/Diode bus relay in the Battery position</li> <li>• Battery terminal voltage between 28 and 32.5 volts</li> </ul>
5.2.3.3.5	Verify battery discharge from high rate to low rate (Figure 5.2-1) by commanding low rate battery discharge on.	ID	Battery discharge rate TM monitor indicates low rate OFF/high rate ON	<ul style="list-style-type: none"> <li>• Same condition as 5.2.3.2.2.</li> </ul>
5.2.3.3.6	Verify battery discharge from low rate to high rate (Figure 5.2-1) by commanding high rate battery discharge on.	ID	Battery discharge rate TM monitor indicates high rate OFF/low rate ON	<ul style="list-style-type: none"> <li>• Same condition as 5.2.3.2.4</li> </ul>

2.3 - 109

EXAMINER



NUMBER	REQUIREMENT STATEMENT	SIGNAL ID	CRITERIA AND SPECIFICATIONS	CONDITIONS, CONSTRAINTS, REMARKS
5.2.4	<b>FCU POWER BUS FUNCTIONS</b>			
5.2.4.1	<b>SA Power to Diode Bus Isolation</b>			
5.2.4.1.1	Verify SA power to Diode Bus diodes (Figure 5.2-1) isolate the Diode Bus from CCC control relay circuits. (+ and - KE SPA input excluded)	No voltage indication on SA power input associated with circuit being tested as measured at SA interface	Initial Conditions	<ul style="list-style-type: none"> <li>• Power applied to diode bus</li> <li>• Battery/Diode Bus relay condition to Diode Bus position (CCC control relay or bypass relays conditioned closed)</li> <li>• CCC control relay or byass relays conditioned closed</li> <li>• SA trim relays closed</li> <li>• SA interface connector disconnected</li> </ul>
5.2.4.1.2	Verify SA power (+ and - KE SPA) to Diode Bus diodes (Figure 5.2-1) isolates the Diode Bus from the SA interfaces	No voltage indication on SA power input associated with circuit being tested as measured at SA interface	Initial Conditions	<ul style="list-style-type: none"> <li>• Power applied to diode bus</li> <li>• SA trim relays closed</li> <li>• SA interface connector disconnected</li> <li>• +KE SPA Diode bus select K27 relay in DBA position and - KE SPA Diode Bus select K47 relay in DBA position</li> </ul>
5.2.4.2	Battery to Diode Bus Continuity Verify continuity from each battery through its associated isolation diodes to the Diode Bus (Figure 5.2-1)	Diode Bus voltage TM monitor indicates nominal voltage (applicable battery voltage less diode voltage drop)	Initial Conditions	<ul style="list-style-type: none"> <li>• Applicable Diode Bus isolation from the other Diode Buses only the associated battery is connected to the above Diode Bus.</li> </ul>

2.3 - 110

EXAMINER

VERIFICATION REQUIREMENTS AND SPECIFICATIONS

NUMBER	REQUIREMENT STATEMENT	SIGNAL ID	CRITERIA AND SPECIFICATIONS	CONDITIONS, CONSTRAINTS, REMARKS
5.2.4.3	Battery to Diode Bus Isolation		Applicable battery voltage monitor (TM or OSE test connector) indicates 0 Volts	Initial Conditions <ul style="list-style-type: none"> <li>Applicable battery power connector disconnect</li> <li>Applicable Diode Bus powered</li> </ul>
5.2.4.3.1	Verify each Diode Bus power is isolated from its associated Battery bus with the SA to Battery/Diode Bus relays in the battery selected mode			
5.2.4.4	Voltage Sensing Circuit and shunt bypass operation			
5.2.4.4.1	Verify that the VSC controlled relays energizes (open) within the battery voltage limit specified		The battery/Diode bus voltage differences increase by 0.7 to 1.0 Vdc when the diode bus voltage reaches $31.41 \pm 0.20$ Vdc	Initial Conditions <ul style="list-style-type: none"> <li>The VSCs enabled</li> <li>The backup shunt relays open</li> <li>Battery terminal voltage at 28 to 31 Vdc</li> <li>Battery/Diode bus relays in the battery position</li> </ul>
5.2.4.4.2	Verify that the VSC controlled relays de-energizes (close) within the battery voltage limit specified		The battery/Diode bus voltage differences increase by 0.7 to 1.0 Vdc when the diode bus voltage reaches $31.41 \pm 0.20$ Vdc	Initial Conditions <ul style="list-style-type: none"> <li>The VSCs enabled</li> <li>The backup shunt relays open</li> <li>Battery/Diode bus relays in the battery position</li> </ul>
5.2.4.4.3	Verify that the shunt diodes can be bypassed by command		The battery/Diode bus voltage differences increase by 0.7 to 1.0 Vdc following a backup Shunt Out command (Table 5.2-1). The Battery/Diode Bus voltage difference decrease by 0.7 to 1.0 Vdc following the Backup Shunt on command	Initial Conditions <ul style="list-style-type: none"> <li>The VSCs enabled and relay energized</li> <li>The battery voltages at 32 -</li> <li>The backup shunt relays open</li> <li>Battery/Diode bus relays in the battery position</li> </ul>

2.3 - 111

EXAMINER

MSFC-HDBK-2221  
February 1992

VERIFICATION REQUIREMENTS AND SPECIFICATIONS

NUMBER	REQUIREMENT STATEMENT	SIGNAL ID	CRITERIA AND SPECIFICATIONS	CONDITIONS, CONSTRAINTS, REMARKS
5.2.4.6	Diode Bus to Main Bus Operation			
5.2.4.6.1	Verify MBA and MBB can be connected and disconnected from DBA and DBB respectively, by command (Table 5.2-1)		Power transfer switches S1 and S2 status monitor respond per Table 5.2-1	Initial Conditions <ul style="list-style-type: none"> <li>• Diode bus powered with no power on the main bus which is to be checked</li> </ul>
	Note: Verify that S1, S2, S3, and S4 wires can be powered from either the Diode Buses or from OSE via J600 test connector		Main bus voltage TM monitor indicates same voltage as applicable, Diode Bus when connected and no voltage when disconnected and no voltage when disconnected	
5.2.4.6.2	Verify MBA and MBB can be connected and disconnected from DBA and DBB, respectively by umbilical controls (+ 28 ± 4 Vdc)		Power transfer switches S1 and S2 status monitor ON and OFF	
5.2.4.6.3	Verify MBA and MBB can be connected and disconnected from DBA and DBB, respectively and MBC can be disconnected from DBC by ACP controls		Power transfer switches S3 and S4 status monitor ON and OFF	
5.2.4.6.3	Verify MBA and MBB can be connected and disconnected from DBA and DBB, respectively and MBC can be disconnected from DBC by ACP controls		Power transfer switches S1, S3 and S4 respond ON and OFF	
5.2.4.7	Main Bus interface with PCU buses C71, C72, C73, and C75			

2.3 - 112

NUMBER	REQUIREMENT STATEMENT	SIGNAL ID	CRITERIA AND SPECIFICATIONS	CONDITIONS, CONSTRAINTS, REMARKS
5.2.4.7.1	Verify C71, C72, C73, and C75 can be powered and unpowered from each main bus in response to command.		C71, C72, C73 and C75 bus telemetry monitors indicate buses powered or unpowered in response to command	
5.2.4.7.2	Verify C71, C72, C73, and C75 can be powered from GSE via test connector J601		C71, C72, C73 and C75 bus telemetry monitors indicate buses powered	Initial Conditions: <ul style="list-style-type: none"> <li>C7 buses unpowered from main buses</li> </ul>
5.2.5	<b>ESSENTIAL BUS INTERFACE</b>			
5.2.5.1	External Essential Bus Isolation and continuity to user I/F			
	Verify Ext EBA isolated from Ext EBB and user equipment can resolve power from either external essential buses		No continuity between the external essential bus power source connector (umb)	
5.2.5.2	Internal Essential Bus Isolation and continuity to user I/F			
	Verify Int KBA, Int KBB, and Int KBC are isolated from each other and the user equipment can receive power from each internal essential buses		Powered Int Essential Bus TM monitor indicates on and the remaining two Internal Essential bus TM monitor indicates off  Each receiver and each CDI monitor indicate on	Initial Conditions: <ul style="list-style-type: none"> <li>Both CDI configured on</li> <li>Only one main bus powered at any one time</li> <li>Internal/External Essential Bus Control Relays in the Internal state</li> </ul>
5.2.5.3	Auto Transfer from Ext Essential Buses to Internal Essential Buses			

2.3 - 113

EXAMINER

VERIFICATION REQUIREMENTS AND SPECIFICATIONS

NUMBER	REQUIREMENT STATEMENT	SIGNAL ID	CRITERIA AND SPECIFICATIONS	CONDITIONS, CONSTRAINTS, REMARKS
	With the essential buses powered from external power source verify that the essential busses autonomously transfer to internal power source upon removal of the external power		Internal essential bus monitors indicates on	Initial Conditions: <ul style="list-style-type: none"> <li>• Diode Bus powered</li> <li>• External essential bus power on</li> <li>• Internal/External Essential Bus Control Relays in the External state</li> </ul>
5.2.5.4	ACP control and monitor  Verify that the internal essential bus power can be controlled on and off via ACP control		Internal essential bus monitors indicates on or off as required  Internal essential bus monitors indicates on or off as required	Initial Conditions: <ul style="list-style-type: none"> <li>• Diode Buses powered</li> <li>• No external essential bus power</li> </ul>
	Verify that the external essential bus power can be controlled on and off via ACP control		Receiver and CDI monitors indicates on or off as required	Initial Conditions: <ul style="list-style-type: none"> <li>• Diode Buses powered</li> <li>• No internal essential bus power</li> </ul>
5.2.5.5	Main buses isolation and continuity to user I/F			Note: ICPU or simulator required
5.2.5.5.1	Verify main bus MBa 1) isolated from MBb and MBc, and 2) bus user equipment receives powr from MBa only by commanding main bus user equipments on/off, as required, to verify equipments power source as MBa.		Bus MB a voltage TM monitor 28 ± 2 Vdc  Bus Mb and Mc voltage monitors indicate OV  Main bus user equipment TM monitors indicate ON  PDU Bus status monitors indicate A on B/C off	Initial Conditions: <ul style="list-style-type: none"> <li>• Power removed from main buses MBb and MBc (S2, S3, and S4 open)</li> <li>• Power applied to main bus MBa (S1 closed)</li> </ul>

EXAMINABLE

NUMBER	REQUIREMENT STATEMENT	SIGNAL ID	CRITERIA AND SPECIFICATIONS	CONDITIONS, CONSTRAINTS, REMARKS
5.2.5.5.2	Verify main bus MBb 1) isolated from MBa and MBc, and 2) bus user equipment receives power from MBb only by commanding main bus user equipments on/off, as required, to verify equipments power source as MBb.		Bus MB voltage TM monitor $29 \pm 2$ Vdc  Bus Ma and Mc voltage monitors indicate OV  Main bus user equipment TM monitors indicate ON  PDU Bus status monitors indicate B on A/C off	Initial Conditions: <ul style="list-style-type: none"> <li>• Power removed from main buses Ma and Mc (S1, S3, and S4 open)</li> <li>• Power applied to main bus Mb (S2 closed)</li> </ul>
5.2.5.5.3	Verify main bus MBc 1) isolated from MBa and MBb, and 2) bus user equipment receives power from MBc only by commanding main bus user equipments on/off, as required, to verify equipments power source as MBc.		Bus MBc voltage TM monitor $29 \pm 2$ Vdc  Bus Ma and Mb voltage monitors indicate OV  Main bus user equipment TM monitors indicate ON  PDU Bus status monitors indicate C on A/B off	Initial Conditions: <ul style="list-style-type: none"> <li>• Power removed from main buses Ma and Mb (S1, and S2 open)</li> <li>• Power applied to main bus Mc (S3 and S4 closed)</li> </ul>
5.3	EPS Interface Tests			
5.3.3	Science Instrument			
5.3.3.1	SI Power			
	Primary bus - connector 24J1 Pins $\epsilon, d, b, Z$ Returns $\epsilon, c, g, Y$			
	Redundant Bus Pins $\epsilon, d, b, Z$ Returns $\epsilon, c, g, Y$			

2.3 - 115

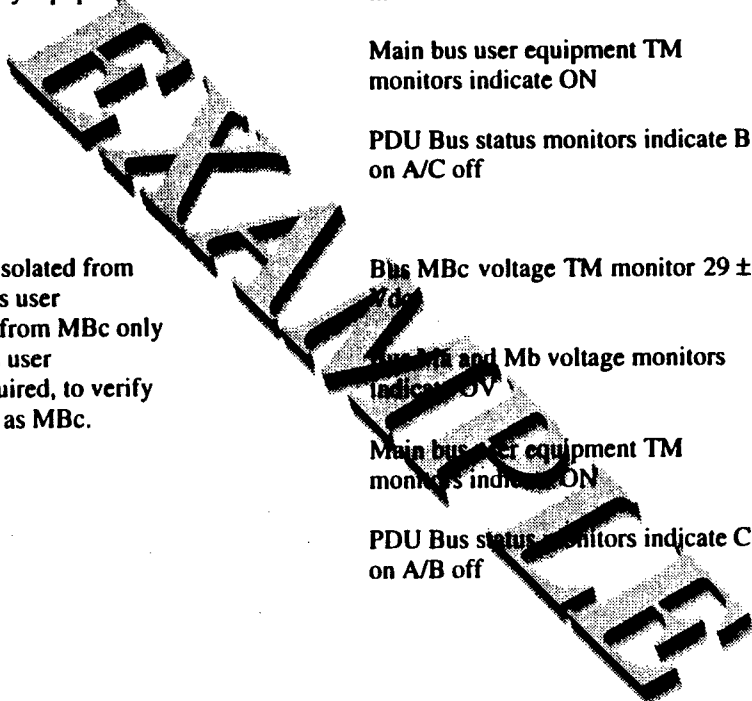

VERIFICATION REQUIREMENTS AND SPECIFICATIONS

NUMBER	REQUIREMENT STATEMENT	SIGNAL ID	CRITERIA AND SPECIFICATIONS	CONDITIONS, CONSTRAINTS, REMARKS
5.3.7.2	<p>a) Powered</p> <p>Verify isolation between those pins comprising the WF/PC power buses (primary and redundant), their returns, and the remaining pins in the connector</p> <p>RM Power</p> <p>Primary - connector 24J61 Pins Y, W Returns X, V</p> <p>Redundant - connector 24J62 Pins Y, W Returns X, V</p>		<p>Between bus and returns: 29 ± 2 Vdc</p> <p>Between returns and all other pins: 0 Vdc</p>	<p>Initial Conditions:</p> <ul style="list-style-type: none"> <li>• Power removed from main buses Ma and Mb (S1, and S2 open)</li> <li>• Power applied to main bus Mc (S3 and S4 closed)</li> </ul>
5.3.8	<p>a) Powered</p> <p>Verify isolation between those pins comprising the HRS RM power bus (primary and redundant), their returns, and the remaining pins in the connector</p> <p>b) Unpowered</p> <p>SOLAR ARRAY INTERFACE</p>	C023B, C024B	<p>Between bus and returns: 29 ± 2 Vdc</p> <p>Between returns and all other pins: 0 Vdc</p> <p>Between bus and returns: 0 Vdc</p> <p>Power off</p>	<p>The Spacecraft Interface Verification Sensing console is used to simulate the response of those associate contractor modules which are not present. The power Console provides insulated solar array power through the diode box.</p>
5.3.8.1	Diode Tray to PCU Power Input Interface			
5.3.8.1.1	Verify the support module side of the Diode Tray interface (connectors V7C1P5, V7C1P6, V7C1P7, ...) are wired in accordance with ICD-05 Figures 3.12, 1-4, -5, -6, and -7.		The harness wiring configuration shall agree with that depicted in the indicated figures	<p>Note:</p> <ol style="list-style-type: none"> <li>1) This verification occurs prior to the completion of the PCU to Diode Tray</li> <li>2) At the time of this verification the harness wiring of the PCU has been verified</li> </ol>

EXAMINER

2.3 - 116

MSFC-HDR-2221  
February 1994

VERIFICATION REQUIREMENTS AND SPECIFICATIONS

NUMBER	REQUIREMENT STATEMENT	SIGNAL ID	CRITERIA AND SPECIFICATIONS	CONDITIONS, CONSTRAINTS, REMARKS
5.3.8.1.2	Verify continuity through the Diode Tray of the Solar Array power input connectors (V7C1J5A, V7C1J6A, V7C1J7A, ...) to the PCU, in accordance with ICD-05 Figures 3.12, 1-4, -5, -6, and -7.		At least functional continuity shall be verified such that the correct Solar Panel Arrays (SPA) interface with the various trim relays (see Fig 5.1-2 and there are no cases of cros wiring of hot to ground	
5.3.8.2	DCE Interface.			
5.3.8.2.1	Power Interface Continuity and Isolation Verification			This verification will be compatible on support module of the interface only. The physical location of this activity will be at connectors C13P1 and C13P2 in order to verify the continuity and isolation through the interfacing harness.
	Primary power - connector C13P1 Pins - 4, 35, 5, 36 Returns - 21, 19, 22, 20			This verification is done with a GSE test aid and is not part of the automated test sequence.
	Redundant power - connector C13P2 Pins - 15, 46, 16, 47 Returns - 31, 29, 32, 30			
a)	Command DCE MAIN POWER ON	B5RH01CE		
b)	Response	B011	On	
	Verify continuity between those pins comprising DCE power buses, main and redundant		Between bus wires: 0 Vdc delta voltage	

EXAMINABLE



NUMBER	REQUIREMENT STATEMENT	SIGNAL ID	CRITERIA AND SPECIFICATIONS	CONDITIONS, CONSTRAINTS, REMARKS
	DCE interface power			Initial Conditions:
5.3.8.2.2	.1 Verify DCE POWER ON			<ul style="list-style-type: none"> <li>• DCE powered off</li> <li>• DCE interface unpowered</li> </ul>
	a) Command DCE MAIN POWER ON	B5RH01CE		
	b) Response DCE main power on DCE redundant power on	B011 B012	On Off	
	c) Command DCE main power off DCE redundant power on	B5RH01CF B2RH01E7		
	d) Response DCE main power off DCE redundant power on	B011 B012	Off On	
	e) Command DCE main power on	B5RH01CF		
	f) Response DCE main power on DCE redundant power on	B011 B012	On On	
	.2 Verify DCE POWER OFF			Initial Conditions:
	a) Command DCE MAIN POWER OFF	B5RH01CF		<ul style="list-style-type: none"> <li>• DCE powered on</li> <li>• DCE interface powered on</li> </ul>
	b) Response DCE MAIN POWER OFF DCE REDUNDANT POWER ON	B011 B012	Off On	
	c) Command DCE MAIN POWER ON DCE REDUNDANT POWER OFF	B5RH01CE B2RH01EB		

2.3 - 118

NUMBER	REQUIREMENT STATEMENT	SIGNAL ID	CRITERIA AND SPECIFICATIONS	CONDITIONS, CONSTRAINTS, REMARKS
	d) Response DCE MAIN POWER ON DCE REDUNDANT POWER OFF	B011 B012	On Off	
	e) Command DCE MAIN POWER OFF	B5RH01CF		
	f) Response DCE MAIN POWER ON DCE REDUNDANT POWER OFF	D012	Off Off	
5.3.8.2.3	Converter Power Interface			Initial Conditions:
	Verify CONVERTER POWER ON; OFF			<ul style="list-style-type: none"> <li>The DCE must be powered (monitors B011 and D012 must be logic '1')</li> </ul>
	a) Command DCE CONVERTERS 1 AND 2 OFF DCE CONVERTERS 1 ON; 2 OFF	B0CD00DC B0CD00DC		Note: The DCE converters, 1 and 2, powered on states are mutually exclusive
	b) Response DCE MAIN FAILURE FLAG DCE REDUNDANT FAILURE FLAG	B124 B125	LOGIC '1' LOGIC '0'	Initial Conditions: <ul style="list-style-type: none"> <li>Converters 1 and 2 powered off.</li> </ul>
	c) Command DCE CONVERTERS 1 AND 2 OFF DCE CONVERTERS 2 ON, 1 OFF	B0CD00DC B0CD00DF		Constraint: The DCE converters 1 and 2 off command must be sent before commanding either of the converters on
	d) Response DCE MAIN FAILURE FLAG DCE REDUNDANT FAILURE FLAG	B124 B125	LOGIC '0' LOGIC '1'	

2.3 - 119

NUMBER	REQUIREMENT STATEMENT	SIGNAL ID	CRITERIA AND SPECIFICATIONS	CONDITIONS, CONSTRAINTS, REMARKS
	e) Command DCE CONVERTERS 1 AND 2 OFF	B0CD00DC		
	f) Response DCE MAIN FAILURE FLAG DCE REDUNDANT FAILURE FLAG	B124 B125	LOGIC '0' LOGIC '0'	
5.3.8.2.5	Instrumentation Interface Continuity			This section verifies the SSM side of the instrumentation interface between the SA and the SSM through the use of the SA instrumentation simulator.
5.3.8.2.5.1	Thermistors and Strain Gauges			Initial Conditions: <ul style="list-style-type: none"> <li>• DCE Main bus I and II powered on (B011, B012-Logic '1')</li> <li>• All GSE wing instrumentation simulators shall be connected to the vehicle interface and close connected to the vehicle interface and close circuited (micro-switches) so the TLM monitors will indicate the micro-switch status as closed.</li> </ul>
II.	DIU 4B VOLTAGE MONITOR SA WING TEMP AND TENSIONS INSTRUMENTATION	D337 B321-B354	5VDC 0 VDC	
	g) Command DCE CONV 1 OFF/2 OFF DCE CONV 1 ON/2 OFF DCE INSTRU SEL MAIN	B0CD00DC B0CD00DE B0CD00E1		

2.3 - 120

EXAMPLE

VERIFICATION REQUIREMENTS AND SPECIFICATIONS

NUMBER	REQUIREMENT STATEMENT	SIGNAL ID	CRITERIA AND SPECIFICATIONS	CONDITIONS, CONSTRAINTS, REMARKS
	h) Response			
	I. DCE MAIN POWER DCE RED POWER	B011 B012	LOGIC '0' LOGIC '0'	
	SA WING TEMP AND TENSIONS INSTRUMENTATION	B321-B354	0 VDC	
5.3.8.2.5.2	Micro-Switches			Initial Conditions:  <ul style="list-style-type: none"> <li>• DCE Main bus I and II powered on (B011, B012-Logic '1')</li> <li>• All micro-switch simulators shall be open (Logical 0).</li> </ul>
	a) Command DIU 4A PRI POWER ON DCE CONV 1 OFF/2 OFF DCE CONV 1 ON/2 OFF	D0CD0001 B0CD0000 B0CD00DE		
	b) Response			
	I. DIU 4A VOLTAGE MON	D336	LOGIC '0'	
	II. DCE MAIN POWER DCE RED POWER	B011 B012	LOGIC '0' LOGIC '0'	
	III. DCE MAIN POWER	B011	LOGIC '1'	
	c) Command DCE INSTRU SEL MAIN +WING PDM MAIN MICRO-SWITCH CLOSED	B0CD00E1		GSE Command This command closes the GSE simulated micro-switch indicating completion of PDM deployment
	d) Response +WING PDM MAIN MICRO-SWITCH - CLOSED	B141	LOGIC '1'	

2.3 - 121

VERIFICATION REQUIREMENTS AND SPECIFICATIONS

NUMBER	REQUIREMENT STATEMENT	SIGNAL ID	CRITERIA AND SPECIFICATIONS	CONDITIONS, CONSTRAINTS, REMARKS
5.3.8.2.6	PDM and SDM DCE -WING (GSE) Interface Functional Continuity			<p>This verification requires the use of the DCE Post Mate (SDM and PDM) continuity check test connectors.</p> <p>This checkout is required prior to sending PDM or SDM commands across the DCE-wing (GSE Simulator) interface, but is only required once, the first time either the flight wings or the GSE simulator is electrically connected to the vehicle.</p> <p>Note: Each pin in</p>
	<p>Measure the resistance between each pin and every other pin in test connectors J11 and J12</p> <p>Results</p> <p>I. Between each SDM motor input and its return</p> <p>II. Between each PDM motor coil input or return</p> <p>III. Between any pin and any other pin except its associated input or return</p>	<p>15 ohms</p> <p>50 ohms</p> <p>Greater than 1 megohms</p>		<p>Initial Conditions:</p> <p>DCE Converter 1 powered on E124 = 1)</p>
5.3.8.2.7	SA PDM DEPLOYMENT - Main Signal Conditioner and Converter			<p>Constraint: The "DCE MOTORS OFF" command (B1CS0000) must be sent prior to commanding one or more motors on.</p>
.1	Verify +WING PDM MAIN MOTOR			<p>Initial Conditions:</p> <ul style="list-style-type: none"> <li>The DCE MOTOR OPERATOR monitors (B126, B127) shall indicate a no-op condition, logical 0.</li> <li>The PDM Deployment micro-switch monitor shall indicate "not deployed", logical 1.</li> </ul>

EXAMPLE

2.3 - 122

MSFC-HDBK-2221  
February 1984

NUMBER	REQUIREMENT STATEMENT	SIGNAL ID	CRITERIA AND SPECIFICATIONS	CONDITIONS, CONSTRAINTS, REMARKS
a)	Command MOTORS OFF	BICS0000		<p>Note: These monitor responses will remain as specified until either:</p> <ol style="list-style-type: none"> <li>1) Micro-switch responses are received by the DCE indicating DEPLOYMENT has been completed (B141, B142) (GSE Simulator) (See note, paragraph 5.3.8.2.3.1d) or,</li> <li>2) DEPLOYMENT is terminated by command</li> </ol>
	PDM +WING MAIN MOTOR DEPLOYMENT PARITY	BICS0680 (BICSXXXX & PD + MMTH & DEPLOY & BIT)		
b)	Response DCE +WING MOTOR OPER Load CURRENT	B126 C371	LOGIC '1' increase in current	<p>Note: • This is a GSE command which simulates the closing the PDM main micro-switch, thereby indicating completion of primary deployment.</p>
c)	Command PDM Deployment complete micro-switch, main (+WING)		CLOSED	
d)	Response +WING PDM DEPLOYED, MAIN Load CURRENT	B141 C371	LOGIC '0' current decrease	<p>Note: Only activation of the redundant PDM Deployment micro-switch changes the state of the "motor operation" status flag, through both main and redundant micro-switches cause the deployment motors to be shut off. The PDU currents must therefore be monitored as an indication of the PDM motor switch-off.</p>
2	Verify +WING PDM REDUNDANT MOTOR	BICS0000 BICS0620 (BICSXXXX & PD + MMTH & DEPLOY & BIT)		<p>Initial Conditions:</p> <ul style="list-style-type: none"> <li>• The DCE MOTOR OPERATION monitor shall indicate a no op condition, logical 0.</li> <li>• The PDM Deployment micro-switch monitor shall indicate "deployed", logical 1.</li> </ul>
a)	Command MOTORS OFF PDM +WING REDUNDANT MOTOR DEPLOYMENT PARITY			

EXAMINABLE

2.3 - 123

NUMBER	REQUIREMENT STATEMENT	SIGNAL ID	CRITERIA AND SPECIFICATIONS	CONDITIONS, CONSTRAINTS, REMARKS
3	b) Response DCE +WING MOTOR OPERATE Load CURRENT	B126 C371	LOGIC '1' increase in current	Reference note, paragraph 5.3.9.2.3.16, this column.
	c) Command PDM Deployment Complete, main micro-switch		CLOSED	GSE Command See paragraph 5.9.3.2.3.1c
	d) Response +WING DEPLOYED MAIN MICRO-SWITCH Load CURRENT	B141 C371	LOGIC '0' current decrease	
	Verify +WING PDM MAIN and REDUNDANT MOTOR SIMULATANEOUS OPERATION			Initial Conditions:  <ul style="list-style-type: none"> <li>• The DCE MOTOR OPERATION monitor shall indicate a no-op condition, logical 0</li> <li>• The PDM Deployment micro-switch monitor shall indicate "not deployed", logical 1</li> </ul>
	a) Command MOTOR OFF PDM +WING REDT. MOTOR PDM +WING MAIN MOTOR DEPLOYMENT	BICS0000 BICS0620 (BICSXXXX & PD + MMTH & DEPLOY & BIT)		The main and redundant motors are powered together.
	b) Response DCE +WING MOTOR OPERATE Load CURRENT	B126 C371	LOGIC '1' current increase	Reference note, this column, paragraph 5.3.8.2.3.1b
c) Command PDM Deployment Complete, main micro-switch			GSE Command See paragraph 5.3.8.2.3.1c	

EXAMINER

2.3 - 124

VERIFICATION REQUIREMENTS AND SPECIFICATIONS

NUMBER	REQUIREMENT STATEMENT	SIGNAL ID	CRITERIA AND SPECIFICATIONS	CONDITIONS, CONSTRAINTS, REMARKS
	d. Response + WING PDM DEPLOYED-MAIN MICRO SWITCH Load CURRENT	B145 C371	LOGIC '0' current decrease	
4	Verify -WING PDM MAIN MOTOR			Initial Conditions:  <ul style="list-style-type: none"> <li>The DCE MOTOR OPERATION monitor shall indicate a no op condition, logical 0.</li> <li>The PDM Deployment micro-switch monitor shall indicate "not deployed", logical 1.</li> </ul>
	a) Command MOTORS OFF PDM -WING MAIN MOTOR DEPLOYMENT PARITY	BICS0000 BICS0640 (BICSXXXX & PD-MMTR & DEPLOY & BIT)		
	b) Response DCE -WING MOTOR OPERATE Load CURRENT	B127 C371	LOGIC '1' current increase	Reference note, this column, paragraph 5.3.8.2.3.1b.
	c) Command PDM Deployment Complete, main micro-switch		CLOSED	
	d) Response -WING PDM DEPLOYED - MAIN MICRO-SWITCH Load CURRENT	B145 C371	LOGIC '0' TBD delta current decrease	

2.3 - 125

EXAMINABLE



VERIFICATION REQUIREMENTS AND SPECIFICATIONS

NUMBER	REQUIREMENT STATEMENT	SIGNAL ID	CRITERIA AND SPECIFICATIONS	CONDITIONS, CONSTRAINTS, REMARKS
.5	Verify -WING PDM MAIN MOTOR			Initial Conditions:
a)	Command MOTORS OFF PDM -WING MAIN MOTOR DEPLOYMENT PARITY	BICS0000 BICS0640 (BICSXXXX & PD-MMTR &DEPLOY & BIT)		<ul style="list-style-type: none"> <li>The DCE MOTOR OPERATION monitor shall indicate a no op condition, logical 0.</li> <li>The PDM Deployment micro-switch monitor shall indicate "not deployed", logical 1.</li> </ul>
b)	Response DCE -WING MOTOR OPERATE Load CURRENT	B127 C371	LOGIC '1' current increase	
c)	Command PDM Deployment Complete, main micro-switch		CLOSED	GSE Command See paragraph 5.3.8.2.3.1c.
d)	Response -WING PDM DEPLOYED - MAIN MICRO-SWITCH Load CURRENT	B145 C371	LOGIC '0' current increase	
.6	Verify -WING PDM MAIN AND REDUNDANT MOTOR SIMULTANEOUS OPERATION			Initial Conditions:
a)	Command MOTORS OFF PDM -WING RED. MOTOR PDM -WING MAIN MOTOR DEPLOY	BICS0000 BICS0250 (BICSXXXX & PD-RMTR & PD-MMTR & DEPLOY)		<ul style="list-style-type: none"> <li>The DCE MOTOR OPERATION monitor shall indicate a no op condition, logical 0.</li> <li>The PDM Deployment micro-switch monitor shall indicate "not deployed", logical 1.</li> </ul>
b)	Response DCE -WING MOTOR OPERATE Load CURRENT	B127 C371	LOGIC '1' current increase	Reference note, paragraph 5.3.8.2.3.1b.

2.3 - 126

VERIFICATION REQUIREMENTS AND SPECIFICATIONS

NUMBER	REQUIREMENT STATEMENT	SIGNAL ID	CRITERIA AND SPECIFICATIONS	CONDITIONS, CONSTRAINTS, REMARKS
c)	Command PDM Deployment Complete, main micro-switch		CLOSED	GSE Command See paragraph 5.3.8.2.3.1c.
d)	Response -WING PDM DEPLOYED - MAIN MICRO-SWITCH Load CURRENT	B145  C371	LOGIC '0'  current decrease	

EXAMPLE

VERIFICATION REQUIREMENTS AND SPECIFICATION.

REQUIREMENT NUMBER	STATEMENT	SIGNAL ID	CRITERIA AND SPECIFICATIONS	CONDITIONS, CONSTRAINTS, REMARKS
5.3.8.2.8	SA PDM Retraction - Main Signal Conditioner and Converter			Initial Conditions:  • DCE Converter 1 powered on (B124 e1)
.1	Verify +WING PDM MAIN MOTOR			Initial Conditions:  • The GSE wing simulator shall be set to indicate that the +WING PDM has been deployed i.e., the +WING PDM deployment main micro-switch, monitor B141, shall be simulated closed.  • The DCE MOTOR OPERATION monitor shall indicate a no op condition, logical 0.
a)	Command MOTORS OFF PDM+WING MAIN MOTOR RETRACTION PARITY BIT	BICS0000 BICS0640 (BICSXXXX & PD-MMTR &DEPLOY & BIT)		
b)	Response DCE +WING MOTOR OPERATE Load CURRENT	B126 C371	LOGIC '1' current increase	

EXAMINABLE

NUMBER	REQUIREMENT STATEMENT	SIGNAL ID	CRITERIA AND SPECIFICATIONS	CONDITIONS, CONSTRAINTS, REMARKS
	c) Action PDM Retraction Begins (PDM Deployment Complete micro-switch main)		OPEN	GSE Command Note: This command opens the simulated micro-switch used to indicate the completion of PDM deployment in section 5.3.2.3.
	d) Response +WING PDM, MAIN MICRO-SWITCH	B141	LOGIC '1'	
	e) Command MOTORS OFF	BICS0000		There is no micro-switch motor shut-off for the array stowing operation. Micro-switches mounted on the SA latches indicate that the array has reached the latch. The latch micro-switch monitor states are downlinked on TLM for ground action.
	f) Response Load CURRENT	C371	current decrease	
2	Verify +WING PDM RED. MOTOR			Initial Conditions:  • See 5.3.8.2.4.1
	a) Command MOTORS OFF PDM+WING RED. MOTOR RETRACTION PARITY BIT	BICS0000 BICS0520 (BICSXXXX & PD-RMTR & RETRACT & BIT)		
	b) Response DCE +WING MOTOR OPERATE Load CURRENT	B126 C371	LOGIC '1' current increase	
	c) Command MOTORS OFF	BICS0000		See note, section 5.5.5.2.4.1e, this column
	d) Response Load CURRENT	C371	current decrease	

2.3 - 129

VERIFICATION REQUIREMENTS AND SPECIFICATIONS

NUMBER	REQUIREMENT STATEMENT	SIGNAL ID	CRITERIA AND SPECIFICATIONS	CONDITIONS, CONSTRAINTS, REMARKS
.3	Verify +WING PDM MAIN AND REDUNDANT SIMULTANEOUS OPERATION			Initial Conditions: See 5.3.8.2.4.1
a)	Command MOTORS OFF PDM +WING REDUNDANT MOTOR PDM +WING MAIN MOTOR RETRACT	BICS0000 BICS01A0 (BICSXXXX & PD+RMTR & PD+MMTR & RETRACT		
b)	Response DCE +WING MOTOR OPERATE Load CURRENT	B126 C371	LOGIC '1' current increase	
c)	Command MOTORS OFF	BICS0000		See Note, section 5.3.8.2.4.1c, this column
d)	Response Load CURRENT	C371	current increase	
5.3.8.2.11	SA SDM Deployment - Main Conditioner and Converter			Initial Conditions: DCE Converter 1 powered on  Constraint: The "DCE Motors Off" command (BICS0000) must be sent prior to commanding one or more motors on.  Note: The SA SDM system contains two sets of micro-switches per wing, one set indicating the stowed configuration, and the other indicating the stowed configuration, and the other indicating the deployed configuration. Each micro-switch has a dedicated DIU port and each is downlinked on TLM as a separate monitor.

2.3 - 130

MSFC-TRK-222  
Rev. 100  
10/19/99

VERIFICATION REQUIREMENTS AND SPECIFICATIONS

NUMBER	REQUIREMENT STATEMENT	SIGNAL ID	CRITERIA AND SPECIFICATIONS	CONDITIONS, CONSTRAINTS, REMARKS
--------	-----------------------	-----------	-----------------------------	----------------------------------

.1

Verify +WING MAIN MOTOR

a) Command  
MOTORS OFF  
SDM +WING MAIN MOTOR  
DEPLOYMENT  
PARITY BIT

TICS0000  
B1CS0608  
PD+MMR1 &  
DEPC & BIT

b) Response  
DCE +WING MOTOR  
OPERATE  
Load CURRENT

B126  
C371

LOGIC '1'  
current  
increase

c) Command  
SDM Stowed micro-switch,  
main (+WING)

OPEN

d) Response  
+WING SDM MAIN USW

B151

MONITOR  
VALUE 0,  
TRANSIT

Ground processing combines these monitors into two bit multi-level discrete event monitors, combining the stowed and deployed micro-switches in pairs. DM-14, the ST Flight Calibration Data Book, defines the calibration of these monitors.

Initial Conditions:

The DCE MOTOR OPERATION monitors (B126, B127) shall indicate no-op conditions, logical 0.

- The SDM main micro-switch monitors (+WING: B151, -WING: B155) shall indicate stowed configurations, monitor value 2.

Note:

Reference Note, this column, paragraph 5.3.8.1.2.1b.

This is a GSE command which simulates the opening of the SDM +WING stowed main micro-switch, thereby indicating a change in SDM configuration from stowed to transit.

Note:

Subparagraphs c) and d) verify the +WING SDM STOWED (or "deployment initiated") micro-switch and SA monitor circuitry interface. This micro-switch is simulated by the GSE, and changing from a closed to an open state (monitor value change from 2 to 0) only sets a bit in the downlink TLM. Since repetition of this state change neither initiates autonomous action by the vehicle, nor verifies new interface circuitry, it has not been included in paragraphs .2 and .3.

VERIFICATION REQUIREMENTS AND SPECIFICATIONS

NUMBER	REQUIREMENT STATEMENT	SIGNAL ID	CRITERIA AND SPECIFICATIONS	CONDITIONS, CONSTRAINTS, REMARKS
	e) Command SDM Deployment Complete micro-switch, main (+WING)		CLOSED	<b>Note:</b> This is a GSE command which simulates the closing of the SDM +WING main deployment micro-switch, thereby indicating the completion of secondary deployment.
	f) Response +WING SDM MAIN USW  Load CURRENT	B151  C371	MONITOR VALUE 1, DEPLOYED current decrease	<b>Note:</b> Only activation of the redundant micro-switch changes the state of the "DCE motor operation" flag, though both main and redundant micro-switches cause the deployment motors to be shut off. The load bus currents must therefore be monitored as an indication of the SDM motor switch-off.  <b>Initial Conditions:</b> See paragraphs 5.3.8.2.7.1
2	Verify +WING SDM REDUNDANT MOTOR			
	a) Command MOTORS OFF SDM +WING MAIN MOTOR DEPLOYMENT PARITY BIT	BICS0000 BICS0602 (BICSXXXX & SD+RMTR & DEPLOY & BIT		
	b) Response DCE +WING MOTOR OPERATE Load CURRENT	B126 C371	LOGIC current increase	<b>Note:</b> Reference Note, this column, paragraph 5.3.8.2.7.1b.
	c) Command SDM Deployment Complete micro-switch, main (+WING)		CLOSED	This is a GSE command. See paragraph 5.3.8.2.7.1e
	d) Response +WING SDM MAIN USW Load CURRENT	B151  C371	MONITOR VALUE 1, DEPLOYED current decrease	See note, paragraph 5.3.8.2.7.1f.

EXAMINER

VERIFICATION REQUIREMENTS AND SPECIFICATIONS

NUMBER	REQUIREMENT STATEMENT	SIGNAL ID	CRITERIA AND SPECIFICATIONS	CONDITIONS, CONSTRAINTS, REMARKS
.3	Verify +WING SDM MAIN AND REDUNDANT MOTOR SIMULTANEOUS OPERATION	B1CS0000 B1CS020A (B1CSXXXX & SD+RMTR & SD+MMTR DEPLOY	LOGIC '1' current increase	Initial Conditions: See paragraph 5.3.8.2.7.
a)	Command MOTORS OFF SDM +WING REDUNDANT MOTOR DEPLOY	B1CS0000 B1CS020A (B1CSXXXX & SD+RMTR & SD+MMTR DEPLOY	LOGIC '1' current increase	Note: Reference Note, this column, paragraph 5.3.8.2.3.1b.
b)	Response DCE +WING MOTOR OPERATE Load CURRENT	C371	CLOSED	This is a GSE command. See paragraph 5.3.8.2.7.1e
c)	Command SDM Deployment Complete micro-switch, main (+WING)	B151	MONITOR VALUE 1, DEPLOYED current decrease	See note, paragraph 5.3.8.2.7.1f.
d)	Response +WING SDM MAIN USW Load CURRENT	C371	CLOSED	Initial Conditions: DCE Converter 1 powered on (B124 + Logical 1)
5.3.8.2.12	SA SDM RETRACTION - Main Signal Conditioner and Converter	B151	MONITOR VALUE 1, DEPLOYED current decrease	Constraint: The "DCE MOTORS OFF" command (B1CS0000) must be sent prior to commanding one or more motors on.

2.3 - 133



VERIFICATION REQUIREMENTS AND SPECIFICATIONS

NUMBER	REQUIREMENT STATEMENT	SIGNAL ID	CRITERIA AND SPECIFICATIONS	CONDITIONS, CONSTRAINTS, REMARKS
1	Verify +WING SDM MAIN MOTOR			
a)	Command MOTORS OFF SDM +WING MAIN MOTOR RETRACTION PARITY BIT	B1CS0000 B1CS0508 (B1CSXXXX & SD+MMTR RETRACT & B1)		
b)	Response DCE +WING MOTOR OPERATE Load CURRENT	B20 C371	LOGIC '1' current increase	Initial Conditions: <ul style="list-style-type: none"> <li>The "DCE MOTOR OPERATION" monitors (B216, B127) shall indicate no-op conditions, logical 0.</li> <li>The SDM main micro-switch monitors (+WING: B151, -WING: B155) shall indicate deployed configurations, monitor value 1.</li> </ul>
c)	Command SDM Deployment Complete micro-switch, main (+WING)			Note: Reference Note, this column, paragraph 5.3.8.2.3.1b.
d)	Response +WING SDM MAIN USW	B151	MONITOR VALUE 0, TRANSIT	GSE COMMAND NOTE: NOTE: This is a GSE command which simulates the opening of the SDM +WING stowed main deployment micro-switch used to indicate +WING SDM deployment completion in paragraph 5.3.8.2.7.1e.

VERIFICATION REQUIREMENTS AND SPECIFICATIONS

NUMBER	REQUIREMENT STATEMENT	SIGNAL ID	CRITERIA AND SPECIFICATIONS	CONDITIONS, CONSTRAINTS, REMARKS
	e) Command SDM Stowed micro-switch, main (+WING)		CLOSED	NOTE: This is a GSE command which simulates the closing of the SDM +WING stowed main retraction micro-switch, thereby indicating the completion of SDM retraction.
	f) Response +WING SDM MAIN USW Load CURRENT	B151	MONITOR VALUE 2, STOWED current decrease	NOTE: Reference note, this column, paragraph 5.3.8.2.7.1f.  INITIAL CONDITIONS: See paragraph 5.3.9.2.8.1.
.2	Verify +WING SDM REDUNDANT MOTOR			
	a) Command MOTORS OFF SDM +WING REDUNDANT MOTOR RETRACTION PARITY BIT	B1CS0015 B1CS002 (B1CSXX)X SD+RMTR RETRACT & BIT)		Initial Conditions: See paragraph 5.3.9.2.8.1
	b) Response DCE +WING MOTOR OPERATE Load CURRENT	B126 C371	LOGIC current increase	Note: Reference Note, this column, paragraph 5.3.8.1.3.1b.
	c) Command SDM Stowed micro-switch, main (+WING)		CLOSED	This is a GSE command. Reference note, this column, paragraph 5.3.8.2.7.1e.
	d) Response +WING SDM MAIN USW Load CURRENT	B151  C371	MONITOR VALUE 2, STOWED  current decrease	Reference note, paragraph 5.3.8.2.7f.

VERIFICATION REQUIREMENTS AND SPECIFICATIONS

NUMBER	REQUIREMENT STATEMENT	SIGNAL ID	CRITERIA AND SPECIFICATIONS	CONDITIONS, CONSTRAINTS, REMARKS
.3	Verify +WING SDM REDUNDANT MOTOR			
a)	Command MOTORS OFF SDM +WING REDUNDANT MOTOR RETRACTION PARITY BIT	B1CS0000 B1CS0502 (B1CSXXXX & SD+RMTR RETRACT & BIT)		Initial Conditions: See paragraph 5.3.9.2.8.1
b)	Response DCE +WING MOTOR OPERATE Load CURRENT	126 C371	LOGIC '1' current increase	Note: Reference Note, this column, paragraph 5.3.8.1.3.1b.
c)	Command SDM Stowed micro-switch, main (+WING)		CLOSED	This is a GSE command. Reference note, this column, paragraph 5.3.8.2.7.1e.
d)	Response +WING SDM MAIN USW Load CURRENT	B151  C371	MOTOR VALUE ? STOWED  current decrease	Reference note, paragraph 5.3.8.2.7f.
5.3.8.2.15	SA + and - WING SIMULTANEOUS SDM DEPLOYMENT - Main signal conditioner and converter			Initial conditions: • DCE converter 1 shall be powered on  CONSTRAINT: The "DCE MOTORS OFF" command (B1CS0000) must be sent prior to commanding one or more motors on.

EXAMINABLE

2.3 - 136

MSFC-HDBK-2221  
February 1994

VERIFICATION REQUIREMENTS AND SPECIFICATIONS

NUMBER	REQUIREMENT STATEMENT	SIGNAL ID	CRITERIA AND SPECIFICATIONS	CONDITIONS, CONSTRAINTS, REMARKS
.1	Verify +/-WING SDM MAIN MOTOR			Initial Conditions:
a)	Command MOTORS OFF SDM +WING MOTOR SDM -WING MOTOR	BICS0000 BICS020C (BICSXXXX & SD- MMTR & DEPLOY)		<ul style="list-style-type: none"> <li>The DCE motor operation monitors (B126, B127) shall indicate - no-op conditions</li> <li>The SDM micro-switch monitors (+WING: B151, B152; -WING: B155, B156) shall indicate stowed configurations, monitor value 2.</li> </ul>
b)	Response DCE +WING MOTOR OPERATE DCE -WING MOTOR OPERATE Load CURRENT	B126 B127 C371	LOGIC '1' LOGIC '1' current increase	Reference Note, this column, paragraph 5.3.8.2.3.1b.
c)	Command SDM Deployment Complete micro-switches redundant (+WING) (- WING)		CLOSED  CLOSED	Note: These are a GSE commands which simulate the closing of the SDM redundant deployment micro-switches on both wings, indicating the completion of secondary deployment..
d)	Response +WING SDM MAIN USW  - WING SDM MAIN USW  Load CURRENT  DCE +WING MOTOR OPERATE DCE -WING MOTOR OPERATE	B152   C371	MONITOR VALUE 1, DEPLOYED  current decrease  LOGICAL 0 LOGICAL 0	

VERIFICATION REQUIREMENTS AND SPECIFICATIONS

NUMBER	REQUIREMENT STATEMENT	SIGNAL ID	CRITERIA AND SPECIFICATIONS	CONDITIONS, CONSTRAINTS, REMARKS
.2	Verify +WING SDM MAIN MOTOR -WING SDM RED. MOTOR			Initial Conditions: See paragraph 5.3.9.2.11.1
a)	Command MOTORS OFF SDM +WING MAIN MOTOR SDM -WING RED. MOTOR DEPLOYMENT	B1CS0000 B1CS0209 (B1CSXXXX & SD+ MMTR & DEPLOY)		
b)	Response DCE +WING MOTOR OPERATE DCE -WING MOTOR OPERATE Load CURRENT	B171 B371	LOGIC '1' LOGIC '1' current increase	
c)	Command SDM Deployment Complete micro-switches redundant (+WING) (- WING)		CLOSED CLOSED	Note: These are a GSE commands, see paragraph 5.3.9.2.11.1c.
d)	Response +WING SDM MAIN USW  - WING SDM MAIN USW  Load CURRENT  DCE +WING MOTOR OPERATE DCE -WING MOTOR OPERATE	B152  C371	MONITOR VALUE 1 DEPLOYED  current decrease  LOGICAL 0 LOGICAL 0	

VERIFICATION REQUIREMENTS AND SPECIFICATIONS

NUMBER	REQUIREMENT STATEMENT	SIGNAL ID	CRITERIA AND SPECIFICATIONS	CONDITIONS, CONSTRAINTS, REMARKS
.3	Verify +WING SDM RED MOTOR -WING SDM MAIN MOTOR			Initial Conditions: See paragraph 5.3.9.2.12.1
a)	Command MOTORS OFF SDM +WING MAIN MOTOR SDM -WING RED. MOTOR RETRACTION	B1CS0000 B1CS0209 (B1CSXXXX & SD+ RMTR & SD -MMTR & RETRACT)		
b)	Response DCE +WING MOTOR OPERATE DCE -WING MOTOR OPERATE Load CURRENT	B126 B127 C71	LOGIC '1' LOGIC '1' current increase	
c)	Command SDM Retraction Complete micro-switches redundant (+WING) (- WING)		CLOSED CLOSED	Note: These are a GSE commands, see paragraph 5.3.9.2.12.1c.
d)	Response +WING SDM RED. USW  - WING SDM RED. USW  Load CURRENT  DCE +WING MOTOR OPERATE DCE -WING MOTOR OPERATE	B152   C371	MONITOR VALUE 1, STOWED  current decrease  LOGICAL 0 LOGICAL 0	

2.3 - 139

VERIFICATION REQUIREMENTS AND SPECIFICATIONS

NUMBER	REQUIREMENT STATEMENT	SIGNAL ID	CRITERIA AND SPECIFICATIONS	CONDITIONS, CONSTRAINTS, REMARKS
.4	Verify +WING SDM RED. MOTOR -WING SDM RED. MOTOR			Initial Conditions: See paragraph 5.3.9.2.12.1
a)	Command MOTORS OFF SDM +WING RED. MOTOR SDM -WING RED. MOTOR RETRACTION	BICS0000 BICS0209 (BICSXXXX & SD+ RMTR & SD MMTR & RETRACT)		
b)	Response DCE +WING MOTOR OPERATE DCE -WING MOTOR OPERATE Load CURRENT	B126 B127 C371	LOGIC '1' LOGIC '1' current increase	
c)	Command SDM Retraction Complete micro-switches redundant (+WING) (- WING)		CLOSED CLOSED	Note: These are a GSE commands, see paragraph 5.3.9.2.12.1c.
d)	Response +WING SDM RED. USW  - WING SDM RED. USW  Load CURRENT  DCE +WING MOTOR OPERATE DCE -WING MOTOR OPERATE	B152 B156  C371 B126 B127	MONITOR VALUE STOWED  current decrease  LOGICAL 0 LOGICAL 0	

2.3 - 140

VERIFICATION REQUIREMENTS AND SPECIFICATIONS

NUMBER	REQUIREMENT STATEMENT	SIGNAL ID	CRITERIA AND SPECIFICATIONS	CONDITIONS, CONSTRAINTS, REMARKS
5.3.8.3	SADE 1 interface		Harness wiring shall agree with the depicted in the reference figure.	<p>Note: Continuity will be verified by sending all the commands and verifying the appropriate (simulated) responses are returned continuity across power lines verified by unit operation.</p> <p>Initial Conditions:</p> <ul style="list-style-type: none"> <li>• Both SADEs powered.</li> <li>• Both main and both redundant SAD motors are powered off (no orientation commands being sent).</li> </ul> <p>Note:</p> <ul style="list-style-type: none"> <li>• The command sequences from counter enable to counter disable must be sent in the order shown.</li> <li>• During testing when the SA wings are not attached, the responses to these commands are simulated by the SIVS console.</li> <li>• During testing with the flight wings installed these commands shall not be sent.</li> </ul>
5.3.8.3.1	Input power verification			
	Verify the support module side for the SADE number 1 power input. The PDU's (connectors C11P1 and C12P1) are wired in accordance with ICD-051, para 3.12.1-2			
5.3.8.3.2	SADE SAD Motor Control			
a.	Verify Motor Control Interface			
a.1	Plus Direction (main motors)			
	a) Command			
	SADE 1 + WNG CNTR ENBL	B0CD00E0		
	SADE 1 + WNG +5.625 DEG/PUL	B0CD00E1		
	SADE 1 + WNG +0.088 DEG/PUL	B0CD00E3		
	SADE 1 + WNG CNTR ENBL	B0CD00E5		
	SADE 1 - WNG +5.625 DEG/PUL	B0CD00E8		
	SADE 1 - WNG +0.088 DEG/PUL	B0CD00E9		
	SADE 1 - WNG CNTR ENBL	B0CD00EB		
		B0CD00ED		

2.3 - 141

EXAMINER



VERIFICATION REQUIREMENTS AND SPECIFICATIONS

REQUIREMENT NUMBER	STATEMENT	SIGNAL ID	CRITERIA AND SPECIFICATIONS	CONDITIONS, CONSTRAINTS, REMARKS
				<ul style="list-style-type: none"> <li>These commands are cross strapped from the DMU CDI module to the SADEs. To verify this command interface, these commands shall be sent from both CDI A and B.</li> </ul>
b.	Response I			
	SADE 1 + WNG MOTOR OP	B28X102B	Logical 1	The OM condition occurs while the SADE is powering the SAD motor, and is OFF otherwise.
	SADE 1 - WNG MOTOR OP	B28X106B	Logical 1	
	SADE 2+ WNG MOTOR OP	B29X112B	Logical 0	Negative check Negative check
	SADE 2 - WNG MOTOR OP	B29X116B	Logical 0	
	Response II			
	SADE 1 + WNG MOTOR OP	B28X102B	Logical 0	Verify that all four monitors read logical 0 after the SADE has removed power from the SADM.
	SADE 1 - WNG MOTOR OP	B28X106B	Logical 0	
	SADE 2+ WNG MOTOR OP	B29X112B	Logical 0	
	SADE 2 - WNG MOTOR OP	B29X116B	Logical 0	
	Response III			
	SADE 1 + WNG POS	B28H301A	Both SADE1 and monitor should show an increase in SA orientation angle of 5.713 degrees from the arbitrary orientation angle existing prior to the above command sequence.	Wing orientation angle is determined by the resolver contained in the SADM on the flight unit. When the flight wings are not attached, the Resolver response will be simulated by the SIVS console.
	SADE 1 - WNG POS	B28H302A		
	SADE 2 + WNG POS	B29H303A		
	SADE 2 - WNG POS	B29H304A		

VERIFICATION REQUIREMENTS AND SPECIFICATIONS

NUMBER	REQUIREMENT STATEMENT	SIGNAL ID	CRITERIA AND SPECIFICATIONS	CONDITIONS, CONSTRAINTS, REMARKS
--------	-----------------------	-----------	-----------------------------	----------------------------------

b) Response I

	SADE 2 + WNG MOTOR OP	B29X112B	Logical 1	Reference the remark to a.1 Response I Negative Check Negative Check
	SADE 2 - WNG MOTOR OP	B29X116B	Logical 1	
	SADE 1 + WNG MOTOR NOT OP	B28X102B	Logical 0	
	SADE 1 - WNG MOTOR NOT OP	B28X106B	Logical 0	

Response II

	SADE 2 + WNG MOTOR NOT OP	B28X102B	Logical 0 Logical 0 Logical 0 Logical 0	Reference the Remark to a.1 Response II
	SADE 2 - WNG MOTOR NOT OP	B28X106B		
	SADE 1 + WNG MOTOR NOT OP	B29X112B		
	SADE 1 - WNG MOTOR NOT OP	B29X116B		

Response III

	SADE 1 + WNG POS	B29H302A	Reference a.1 Response III	reference remark to a.1 Response III
	SADE 1 - WNG POS	B28H302A		
	SADE 2 + WNG POS	B29H303A		
	SADE 2 - WNG POS	B29H304A		

5.3.9.3.3

SADE Brake Control

Verify SADE to SAD brake (simulated) continuity

- a. Command  
Reference 5.3.9.3.2a.1 wing orientation command sequence

The SA Brake controlled by the Timing Control module in the SADE and is not commandable directly. After a wing orientation command is sent from the DMU and the motor (SAD) is powered on).

VERIFICATION REQUIREMENTS AND SPECIFICATIONS

NUMBER	REQUIREMENT STATEMENT	SIGNAL ID	CRITERIA AND SPECIFICATIONS	CONDITIONS, CONSTRAINTS, REMARKS
	b) Response			
	A voltage shall be observed across the SADE - Brake interface during the execution of the orientation command.		Initially: 20 + TBD VDC Subsiding to : 5 + TBD VDC	Prior to powering off the SAD the brake is again engaged (powered off).  Note: <ul style="list-style-type: none"> <li>• Voltage across the brake from 20 VDC initially to 5 VDC while the brake is disengaged.</li> <li>• The SADE-Brake interface occurs, on both SADES, for the +wing at SADE connector J5: pins 6,7 - brake power pins 18,19 - brake power return</li> <li>for the - wing, SADE connector J6: pins 6,7 - brake power pins 18,19 - brake power return</li> </ul>
5.3.9.3.4	SADE - OLD Interface			
	Verify SADE OLD POWER ON			
	a. Command SADE 1 OLD POWER ON	COCD00**		
	b. Response SADE 1 OLD POWER ON SADE 2 OLD POWER OFF	B34X013B B34X014B		Initial Conditions: <ul style="list-style-type: none"> <li>• Both SADE 1 and 2 powered on</li> <li>• Both SADE 1 and 2 OLD powered off</li> </ul> This command sequence checks OLD power line continuity, as well as isolation of the OLD power on commands through negative testing.
	c. Command SADE 1 OLD POWER OFF SADE 2 OLD POWER ON	CYRB11** COCD00**		Note: These commands must be sent in the order written to achieve the negative tests.

EXAMPLE

2.3 - 146

VERIFICATION REQUIREMENTS AND SPECIFICATIONS

NUMBER	REQUIREMENT STATEMENT	SIGNAL ID	CRITERIA AND SPECIFICATIONS	CONDITIONS, CONSTRAINTS, REMARKS
d..	Response SADE 1 OLD POWER OFF SADE 2 OLD POWER ON	B34X013B B34X014B		
e.	Command SADE 1 OLD POWER ON	C0CD00**		
f.	Response SADE 1 OLD POWER ON SADE 2 OLD POWER OFF	B34X013B B34X014B		
b.	Verify SADE OLD functional response			<p><b>WARNING:</b> This verification must not be done with the SAs attached. The ODK is a one-shot mechanism and once activated, must be disassembled to be reset. When the SA wings are present continuity of the SADE-OLD interface lines will be verified through the use of the test plug on the SADE.</p> <p><b>Initial Conditions:</b> The SIVS xonsole shall indicate both + and - wings OLDs not released.</p>
6.1	SADE 1 OLD functional response			
a.	Command SADE 1 + WING OLD ON	B0CD00**		
b.	Response SADE 1 + WING OLD released SADE 1 - WING OLD not released SADE 2 + WING OLD released SADE 2 - WING OLD released	B28X103B B28X107B B28X113B B28X117B	Logical 0 Logical 1 Logical 0 Logical 1	

EXAMINABLE

VERIFICATION REQUIREMENTS AND SPECIFICATIONS

NUMBER	REQUIREMENT STATEMENT	SIGNAL ID	CRITERIA AND SPECIFICATIONS	CONDITIONS, CONSTRAINTS, REMARKS
	Load bus Current Primary Redundant	C33C371A C33C373A	These monitors shall show an increase in power usage of 200 Watts above what the vehicle was using prior to sending the OLD ON command.	Note: Only one of the bus current monitors need be monitored as we are verifying the SA function.
c.	Command SADE 1 + WING OLD ON	B0CD00**		
d.	Response SADE 1 + WING OLD released SADE 1 - WING OLD not released SADE 2 + WING OLD released SADE 2 - WING OLD not released	B28X103B B28X107B B28X113B B28X117B	Logical 0 Logical 1 Logical 0 Logical 1	
	Load Bus Current Primary Redundant	C33C371A C33C373A	These monitors shall show a 200 watt decrease in power usage as a result of the OLD OFF command. (an OLD power usage of zero watts)	Note: Only one of the bus current monitors need be monitored as we are verifying the SA function.
	Load Bus Current Primary Redundant	C33C371A C33C373A	Reference the criteria for b.1, b	Reference the criteria for b.1, b
g.	Command SADE 1 + WING OLD ON	B0CD00**		
h.	Response SADE 1 + WING OLD released SADE 1 - WING OLD released SADE 2 + WING OLD released SADE 2 - WING OLD released	B28X103B B28X107B B28X113B B28X117B	Logical 0 Logical 0 Logical 0 Logical 0	

2.3 - 148

VERIFICATION REQUIREMENTS AND SPECIFICATIONS

NUMBER	REQUIREMENT STATEMENT	SIGNAL ID	CRITERIA AND SPECIFICATIONS	CONDITIONS, CONSTRAINTS, REMARKS
	Load bus Current Primary Redundant	C33C371A C33C373A	These monitors shall show the total power usage of the OLDs at 400 watts	Reference the note to b.1, b
i.	Command SADE 1 + WING OLD ON	B0CD00**		
j.	Response SADE 1 + WING OLD released SADE 1 - WING OLD not released SADE 2 + WING OLD released SADE 2 - WING OLD not released	B28X103B B28X107B B29X113B B29X117B	Logical 0 Logical 1 Logical 0 Logical 1	
b.2	SADE 2 OLD functional response			Note: Only one of the bus current monitors need be monitored as we are verifying the SA function.
a.	Command SADE 2 + WING OLD ON	B0CD00**		
b.	Response SADE 1 + WING OLD released SADE 1 - WING OLD released SADE 2 + WING OLD released SADE 2 - WING OLD released	B28X103B B28X107B B29X113B B29X117B	Logical 0 Logical 1 Logical 0 Logical 1	
	Load bus Current Primary Redundant	C33C371A C33C373A	These monitors shall show an increase in power usage of 200 watts above what the vehicle was using prior to sending the OLD ON command.	Reference the criteria for b.1, b
c.	Command SADE 2 + WING OLD ON	B0CD00**		

2.3 - 149

VERIFICATION REQUIREMENTS AND SPECIFICATIONS

NUMBER	REQUIREMENT STATEMENT	SIGNAL ID	CRITERIA AND SPECIFICATIONS	CONDITIONS, CONSTRAINTS, REMARKS
d.	Response			
	SADE 1 + WING OLD released	B28X103B	Logical 0	
	SADE 1 - WING OLD not released	B28X107B	Logical 1	
	SADE 2 + WING OLD released	B29X113B	Logical 0	
	SADE 2 - WING OLD not released	B29X117B	Logical 1	
	Load bus Current Primary Redundant	C33C371A C33C373A		These monitors shall show an OLD power usage of zero watts.

**EXAMPIE**

## 7.0 DATA MANAGEMENT SUBSYSTEM AND INTERFACES

### 7.1 INTRODUCTION AND GENERAL REQUIREMENTS

This paragraph contains the verification requirements of the Data Management Subsystem (DMS) and hardware/software interfaces of this subsystem to other elements of the assembled flight hardware.

7.1.1 Scope. The DMS verification requirements presented herein shall functionally verify all signal, data, command and power paths (including cross-strapping) within/external to the DMS.

7.1.2 Subsystem Description. The major hardware elements of the DMS are a DF-224 computer, Data Management Unit (ADMU), Data Interface Units (DIUs), Engineering Scientific Tape Recorders (ESTRs) and Oven Controlled Crystal Oscillators (OCXOs). The software contained in the DF-224 performs PCS computations and maneuver/stability command generation necessary for scientific observations. In addition, the software performs stored command processing, various Safing System checks and responses, telemetry format control, solar array and high gain antenna pointing, and electrical power subsystem data processing. The general DMS functional capabilities are outlined as follows:

- The DMS shall have the functional responsibilities for the acquisition, processing, storage, and dissemination of all data between the SSM I&C Subsystem and other Subsystems.
- The DMS shall perform data acquisition functions, with appropriate software perform the Pointing Control Subsystem computations which are required for momentum management and generation of torque commands, perform the command processing, provide the required storage for data commands, and provide the central timing.
- The DMS shall be capable of providing real-time or stored scientific and engineering data to the I&C subsystem for transmission to the TDRSS. The real-time information data rate shall be nominally 1 Mbps or 4 kbps for science and 0.5, 4 or 32 kbps for engineering data. The stored science or engineering data rate shall be 1.024 Mbps.
- The DMS shall provide a Vehicle Time Word in (VTW) a 32 bit, binary progression format with a least significant bit of 0.125 second. The DMS shall provide a 6.144 MHz sine wave clock, and a 1.024 MHz square wave clock. The 6.144 MHz clock frequency



stability shall be  $1 \times 10^{-9}$  errors in 24 hours. For TLM programmable formats at 4 kbps and above, the DMS shall provide to the SI C&DH a Master Timing Pulse (MTP) relatable to within one microsecond of the VTW at each 0.5 second transition. For TLM fixed formats and the 500 bps programmable format, the DMS shall provide to the SI C&DH the MTP coincident with the TLM major from sync pulse. The timing delay uncertainty for any time word path through the flight hardware known to within 5 microseconds.

- The DMS shall be capable of acquisition, analog conversion formatting, and buffering of engineering data. It shall also be capable of receiving and merging the SSM data with the OTA and SI C&DH engineering data prior to storage for transmission. This DMS engineering bit stream shall be capable of operating at 0.5, 4 and 32 kbps, changeable by ground command. The engineering data stream shall contain timing information in an elapsed time binary count. The timing information shall be suitable to the telemetry frame structure.
- The DMS shall convolutionally encode the real-time and stored engineering and science data bit streams prior to transfer of data to the I&C Subsystem.
- The DMS shall optionally interleave the science data bit stream (1.024 Mbps) prior to transfer to the I&C Subsystem.

**VERIFICATION REQUIREMENTS AND SPECIFICATIONS**

<b>NUMBER</b>	<b>REQUIREMENT STATEMENT</b>	<b>SIGNAL ID</b>	<b>CRITERIA AND SPECIFICATIONS</b>	<b>CONDITIONS, CONSTRAINTS, REMARKS</b>
7.2	<b>DATA MANAGEMENT SYSTEM - VERIFICATION BY TEST</b>			
7.2.1	<b>DATA MANAGEMENT UNIT (DMU)</b>			
7.2.1.1	<b>COMMAND I/F MODULE (CMD)</b>			Perform the verification on both CMD modules.
7.2.1.1.1	Verify routing capability of [unclear] from CDI <ul style="list-style-type: none"> <li>• Hw Load</li> <li>• Sw Load</li> <li>• RTC</li> <li>• Configuration and Control Commands</li> </ul>			Routing must be accomplished at 125 and 1000 BPS. This test could be performed along with CDI test, Paragraph 7.2.12. The CMD Module must be in Normal Mode for this verification. Perform as ongoing test during verification.
7.2.1.1.2	Verify routing capability <ul style="list-style-type: none"> <li>• In Bypass</li> <li>• High Level Discrete</li> <li>• Serial Digital Words</li> <li>• Data to DF-224</li> <li>• Configuration and Control Commands</li> </ul>			Must be performed at 125 and 1000 bps within continuous bit stream and with time lapse between commands. Perform as ongoing test during verification activities.
7.2.1.1.3	Verify all commands executable by CMD module.			Perform as ongoing test during verification activities.
7.2.1.1.4	Verify transition of CMD module to bypass mode <ul style="list-style-type: none"> <li>• With selection of CMD module</li> <li>• SM activation from SMEA</li> </ul>	Logic 1		Module must be in normal mode prior to command execution (Status Register 3 Bit 22 = 1)
7.2.1.1.5	(a) Verify transition of CMD module to normal mode with command (b) Verify transition of CMD module to diagnostic mod with selection of LMD module.	Logic 0		Modules must be in BYPASS or DIAGNOSTIC prior to command to place it in normal mode.  As above.

2.3 - 153

**EXAMINER**

VERIFICATION REQUIREMENTS AND SPECIFICATIONS

NUMBER	REQUIREMENT STATEMENT	SIGNAL ID	CRITERIA AND SPECIFICATIONS	CONDITIONS, CONSTRAINTS, REMARKS
	(c) Verify no DIO CMDS executed in diagnostic mode.			As above.
	(d) Verify data requests are executed in diagnostic mode.			As above.
7.2.1.1.6	Verify OBSW unable to execute the following commands when the CMD module is in bypass <ul style="list-style-type: none"> <li>• DIU Commands</li> <li>• C/D Register Selection</li> <li>• RGA Mode Control</li> <li>• FHST Commands</li> <li>• TRI Mode Control Commands</li> <li>• COM module Select</li> <li>• Select TM Rate/Format</li> </ul>			SPCs contained in data load on Vehicle Time incrementing shall not be executed by the DIU's.
7.2.1.1.7	Verify with the CMD module is in BYPASS the OBSW can <ul style="list-style-type: none"> <li>* Request TLM via DIU's</li> <li>• Request status from DMU modules</li> </ul>		GSE remains in last commanded bitrate format	Programmable format in effect.
7.2.1.2	DATA INTERFACE UNIT INTERFACE (DIUI)			Perform the verification on both DIUI's and TFC's.
7.2.1.2.1	Verify C/D register bit configurations as follows: (a) 1 1 1 1 1 1 1 1 (b) 0 0 0 0 0 0 0 0		Verified on Status Reg-0	NOTE: DIUs must be configured so that TLM is not lost since both sides of DIU are not normally powered.
7.2.1.2.2	Verify C/D registers can be loaded via stored program command per 7.2.1.2.1			Computer bypass must not be in effect.

2.3 - 154

EXAMINABLE

VERIFICATION REQUIREMENTS AND SPECIFICATIONS

NUMBER	REQUIREMENT STATEMENT	SIGNAL ID	CRITERIA AND SPECIFICATIONS	CONDITIONS, CONSTRAINTS, REMARKS
7.2.1.2.4	Verify ability to decode DIU address and route request to proper DIU			This is a continous analysis task. This verification includes analogs, bilevels, serial digital data high level discretes, low level discretes and serial digital commands.
7.2.1.2.5	Verify with echo check enabled command echo miscompare the DMU sets proper bit(s) of DMU status register - 1			Must be performed for each DIU. The C/D register could be set such that the command or data request is issued to an off DIU.

**EXAMPLE**

VERIFICATION REQUIREMENTS AND SPECIFICATIONS

Table 7.2.1-1

Configuration	DMU*	CIF	TIM	DIUI	TFC	COM	CMD	TRI	FHSTI	RGAI
1**	A	A	A	A	A	A	A	A	A	A
2	A	B	A	A	A	A	A	A	A	A
3	A	B	B	A	A	A	A	A	A	A
4	A	B	B	B	A	A	A	A	A	A
5	A	B	B	B	B	A	A	A	A	A
6	A	B	B	B	B	B	A	A	A	A
7	A	B	B	B	B	B	B	A	A	A
8	A	B	B	B	B	B	B	B	A	A
9	A	B	B	B	B	B	B	B	B	A
10**	A	B	B	B	B	B	B	B	B	B
11**	B	B	B	B	B	B	B	B	B	B
12	B	A	B	B	B	B	B	B	B	B
13	B	A	B	B	B	B	B	B	B	B
14	B	A	A	B	B	B	B	B	B	B
15	B	A	A	A	A	B	B	B	B	B
16	B	A	A	A	A	A	B	B	B	B
17	B	A	A	A	A	A	A	B	B	B
18	B	A	A	A	A	A	A	A	B	B
19	B	A	A	A	A	A	A	A	A	B
20**	B	A	A	A	A	A	A	A	A	A

NOTE: Even though the RGAI, TRI & FHSTI do not supply data during this test, a glitch hunt is being performed to verify all modules in their various combinations. All other modules are functionally exercised. Reference Table 7.2.1-2 for commands and telemetry.

\* DMU is used in this table refers to the power converter, of which there are two, in the DMU.

\*\* Minimum configurations required to be tested. DMS modules cross-strapped paths must be verified including the CDI.

VERIFICATION REQUIREMENTS AND SPECIFICATIONS

NUMBER	REQUIREMENT STATEMENT	SIGNAL ID	CRITERIA AND SPECIFICATIONS	CONDITIONS, CONSTRAINTS, REMARKS
7.2.1.2.6	Verify with echo check disabled and a command echo miscompare the DIUI sets proper bit(s) of DMU status register - 1			
7.2.1.2.7	Verify the echo check of the DIUI is enabled with (a) selection of DIUI (b) command			
7.2.1.2.8	Verify with echo check enabled or disabled and a data request echo miscompare the DIUI sets proper (bits) of DMU status register -1		Data in DATA FIFO	This could be accomplished by changing the C/D register or command a DIU off.
7.2.1.2.9	Verify First-In-First-Out (FIFO) buffer never indicates full. (a) REQ FIFO (b) DATA FIFO	Logic 0 Logic 0		This is a continuous analysis task. Reference DMU status register-1, bits 19 and 21.
7.2.1.2.10	Verify data routing from (a) DIUI to DF-224 (b) DIUI to TFC (c) DF-224 to TFC (d) DIUI to DF-224 & TFC		(a) Correct data obtained by OBSW (b), (c) and (d) - Correct data appears on downlink TLM	(a) addresses 232 and 233 (b) addresses 234 and 235 (c) addresses 244 and 245 (d) addresses 236 and 237 Can be performed as part of normal test sequence.
7.2.1.3	Telemetry Format and Control Module (TFC)			Special test not required, done as part of normal test sequence.
7.2.1.3.1	Verify TFC accepts and outputs data from DIUI at commanded rates for: (a) DF-224 provided requests (b) ROM (fixed format) provided requests			OBSW to issue cmd to TFC for bit rate change. Special test not required, done as part of normal test sequence.

EXAMINER

2.3 - 157

VERIFICATION REQUIREMENTS AND SPECIFICATIONS

NUMBER	REQUIREMENT STATEMENT	SIGNAL ID	CRITERIA AND SPECIFICATIONS	CONDITIONS, CONSTRAINTS, REMARKS
7.2.1.3.2	Verify backup TLM on with (a) SM activation (b) Computer request (c) TLM rate select command		4 kbps on and processed by ground software	This is the ROM in the TFC (4 kbps). Both ROMs must be verified.
7.2.1.3.3	Verify backup TLM on by command		500 BPS processed by ground software	This is the ROM in the TFC (500 bps). Both ROMs must be verified.
7.2.1.3.4	Verify that parity check is good for messages sent to DIU		Status register -1 indicates no parity error	Performed on a continuous basis. Ref Section 7.2.4.2
7.2.1.4	TIMING MODULE (TIM)			The OCXOs are cross-strapped at the output of a bandpass filter in each TIM.
7.2.1.4.1	Verify TIM A operates with OCXO A and OCXO B			Special test not required, done as part of normal procedure.
7.2.1.4.2	Verify TIM B operates with OCXO A and OCXO B			Special test not required, done as part of normal procedure.
7.2.1.4.3	Verify each TIM provides the OTA with 40 Hz signal			Perform the verification as follows: 1. Prior to OTA electrical connection verify specified values. 2. After OTA electrical connection proper operation by user shall satisfy the verification.
7.2.1.4.4	Verify each TIM provides the SIC & DH 1.024 MHz signal		Verify by SIC & DH operation	Ref. paragraph 7.4.1.2.3.
7.2.1.4.5	Verify TIM provides the DF-224 with (a) 1 kHz interrupt (b) 40 Hz signal		Verified by DF-224 operation	
7.2.1.5	COMMUNICATION INTERFACE (COM)			Perform this verification in conjunction with (Section 6.0) of this document.

2.3 - 158

EXAMINABLE

VERIFICATION REQUIREMENTS AND SPECIFICATIONS

NUMBER	REQUIREMENT STATEMENT	SIGNAL ID	CRITERIA AND SPECIFICATIONS	CONDITIONS, CONSTRAINTS, REMARKS
7.2.1.5.1	Verify COM "A" accepts data from TFC and (a) Convolution encodes (rate 1/2) output to Q-channel port of MA Transponder A and B (b) Convolution encodes (rate 1/2) output to I-channel port of MA Transponder A and B (c) Outputs to STDN Input #1 Port of MA Transponder A and B			Perform this verification at 0.5, 4 and 32 kbps data rates. Performed for inputs from TFC A and TFC B.
7.2.1.5.2	Verify COM "A" accept data from C&DH A and (a) Convolution encodes (rate 1/2) output to I-channel port of MA Transponder A and B (b) Outputs to STDN Input #1 Port of MA Transponder A and B. (c) Routes the data to the TRI for recording (d) Convolution encodes (rate 1/3) output to the SA Input #1 Port of SSA Transmitter A and B (e) Convolution encodes (rate 1/3) and interleaves output to the SA Input #1 Port of SSA Transmitter A and B	Without SI C&DH the interface gives steady pattern		Without SI C&DH open inputs give "1" on all bits.
7.2.1.5.3	Verify COM "A" accept data from TRI and (a) Outputs to STDN Input #1 Port of MA Transponder A and B. (b) Convolution encodes (rate 1/3) output to I-channel port of MA Transponder A and B (c) Convolution encodes (rate 1/3) and interleaves output to the SA Input #1 Port of SSA Transmitter A and B (d) Convolution encodes (rate 1/2) output to I-channel port of MA Transponder A and B			NOTE: All data in this verification is at 1.024 MB.

REPLACEMENT



VERIFICATION REQUIREMENTS AND SPECIFICATIONS

NUMBER	REQUIREMENT STATEMENT	SIGNAL ID	CRITERIA AND SPECIFICATIONS	CONDITIONS, CONSTRAINTS, REMARKS
7.2.1.5.4	<p>Verify COM "A" accepts full frame memory dump (DF-224) from CIF and</p> <ul style="list-style-type: none"> <li>(a) Outputs to STDN Input #1 Port of MA Transponder A and B.</li> <li>(b) Convolution encodes (rate 1/2) output to I-channel port of MA Transponder A and B</li> <li>(c) Convolution encodes (rate 1/3) output to Q-channel port of MA Transponder A and B</li> </ul>			Perform this verification at 4 kbps .
7.2.1.5.5	<p>Verify COM "B" accept data from TFC and</p> <ul style="list-style-type: none"> <li>(a) Convolution encodes (rate 1/2) output to Q-channel port of MA Transponder A and B</li> <li>(b) Convolution encodes (rate 1/2) output to I-channel port of MA Transponder A and B</li> <li>(c) Outputs to STDN Input #2 Port of MA Transponder A and B.</li> </ul>			Perform verification at 0.5,4 and 32 kbp. Performed for inputs from TFC A and TFC B.
7.2.1.5.6	<p>Verify COM "B" accept data from SI C&amp;DH and</p> <ul style="list-style-type: none"> <li>(a) Convolution encodes (rate 1/3) output to I-channel port of MA Transponder A and B</li> <li>(b) Outputs to STDN Input #2 Port of MA Transponder A and B.</li> <li>(c) Routes the data to the TRI, for recording</li> <li>(d) Convolution encodes (rate 1/3) output to the SA Input #2 Port of the SSA Transmitter A and B.</li> <li>(e) Convolution encodes (rate 1/3) and interleaves output to the SA Input #2 Port of the SSA Transmitter A and B.</li> </ul>		Without SI C&DH the interface gives steady pattern	<p>Perform verification (a,b, and c) at 4 and 32 kbp data rate, and verification (b, c, d, and e) at 1.024 mbps.</p> <p>Without SI C&amp;DH open inputs give "1" on all bits.</p>

2.3 - 160

VERIFICATION REQUIREMENTS AND SPECIFICATIONS

NUMBER	REQUIREMENT STATEMENT	SIGNAL ID	CRITERIA AND SPECIFICATIONS	CONDITIONS, CONSTRAINTS, REMARKS
7.2.1.5.7	Verify COM "B" accepts data from TRI and (a) Outputs to STDN Input #2 Port of MA Transponder A and B. (b) Convolution encodes (rate 1/3) output to the SA Input #@ Port of SSA Transmitter A and B (c) Convolution encodes (rate 1/3) and interleaves output to the SA Input #2 Port of the SSA Transmitter A and B. (d) Convolves, encodes (rate 1/2) output to I-Channel port of MA Transponder A and B.			Perform this verification at 1.024 mbps.
7.2.1.5.8	Verify COM "B" accepts full frame memory dump (DF-224) from CIF and (a) Outputs to STDN Input #2 Port of MA Transponder A and B. (b) Convolution encodes (rate 1/2) output to I-channel port of MA Transponder A and B (c) Convolution encodes (rate 1/2) output to Q-channel port of MA Transponder A and B			Perform this verification at 4 kbps.
7.2.1.6	TAPE RECORDER INTERFACE (TRI)			All preselect logic shall be exercised during the tape recorder functional test. Just a command/data check shall be performed here. Both sources of TRI setup must be verified, i.e., via DF-224 software and via CMD modules.
7.2.1.6.1	Verify ability to preselect any tape recorder for: (a) Safe mode data <ul style="list-style-type: none"> <li>• TR #1</li> <li>• TR #2</li> <li>• TR #3</li> </ul> (b) Engineering data <ul style="list-style-type: none"> <li>• TR #1</li> <li>• TR #2</li> <li>• TR #3</li> </ul>			

2.3 - 161

EXAMINER

VERIFICATION REQUIREMENTS AND SPECIFICATIONS

NUMBER	REQUIREMENT STATEMENT	SIGNAL ID	CRITERIA AND SPECIFICATIONS	CONDITIONS, CONSTRAINTS, REMARKS
	(c) Science data • TR #1 • TR #2 • TR #3			
7.2.1.6.2	Verify TRI routes science data at 4, 32 and 1024 kbps to TR			Data shall be recorded and read out at the defined rates during the tape recorder test. Normally performed as part of Section 7.2.3.4.
7.2.1.6.3	Verify TRI routes engineering data at 4, 32 and 32 kbps to TR			Data shall be recorded and read out at the defined rates during the tape recorder test. Normally performed as part of Section 7.2.3.3.
7.2.1.6.4	Verify TRI routes TR data to COM A or B (from all 3 recorders)			
7.2.1.7	FIXED HEAD STAR TRACKER INTERFACE (FHSTI)			FHST hardware must be available for these tests. This may be performed as part of the PCS tests Section 8.0.
7.2.1.7.1	Verify both FHSTI modules operate with either DMU power supply			
7.2.1.7.2	Verify GHSTI A and B accepts 24-bit command from computer and routes 16-bit serial digital word from the FHST's into a 24-bit word for the computer		FHST responds to command	
7.2.1.7.3	Verify the FHSTI A and B formats the 16 bit serial digital word from the GHST's into a 24-bit word for the computer		FHST data word read on TLM	
7.2.1.7.4	Verify the FHSTI A and B to each FHST operates in both the search and track mode		During search horizontal and vertical position varying. During track mode hor. and ver. position fixed at self test position.	Initial conditions: FHST in self test mode.

2.3 - 162

EXAMINER

VERIFICATION REQUIREMENTS AND SPECIFICATIONS

NUMBER	REQUIREMENT STATEMENT	SIGNAL ID	CRITERIA AND SPECIFICATIONS	CONDITIONS, CONSTRAINTS, REMARKS
7.2.1.7.5	Verify all DIU command for shutter closed	Shutter closed monitor		This is shutter control via the PDU.
7.2.1.8	<b>RATE GYRO ASSEMBLY INTERFACE (RGAI)</b>			Each RGAI, of which there are two, contains six dedicated channels, i.e., one for each of the six gyros in the RGAs. This may be performed as part of the PCS tests Section 8.0.
7.2.1.8.1	Verify TRI routes engineering data and 32 kbps to TR	Gyro TLM indicates Gyro ID, counts, cycles/error check		Rate information from the addressed channel (gyro output) is consistent with its orientation (lg field) relative to local vertical.
7.2.1.8.2	Verify each RGAI channel provides gyro rate data to the DF-224	Indicated "count" on GYRO TLM changes when HIGH/LOW command		The computer supplies the rate change command for all 6 gyros.
7.2.1.9	<b>COMPUTER INTERFACE MODULE (CIF)</b>			Requires PSEA hardware.
7.2.1.9.1	Verify each CIF receives the two (2) Keep-Alive (DA) words from the DF-224, properly decodes the words and outputs pulses to PSEA	PSEA does not issue safe mode commands		
7.2.1.9.2	Verify CIF STOPS KA's to PSEA when DF-224 is not operating	PSEA issues safe mode commands Section 9.0		Perform as part of safe mode tests
7.2.1.10	<b>COMMAND DATA INTERFACE (CDI)</b>			
7.2.1.10.1	<b>MA RECEIVER TO CDI INTERFACE VERIFICATION</b>			Perform the verification for the following configurations: <ul style="list-style-type: none"> <li>• MA RCVR A to CDI A</li> <li>• MA RCVR B to CDI B</li> </ul> This verification could be performed in conjunction with Section 5, I&C.

2.3 - 163

EXPERIMENTAL

VERIFICATION REQUIREMENTS AND SPECIFICATIONS

NUMBER	REQUIREMENT STATEMENT	SIGNAL ID	CRITERIA AND SPECIFICATIONS	CONDITIONS, CONSTRAINTS, REMARKS
7.2.1.10.2	Verify the CDI accepts valid command messages and a) executes commands b) routes to proper interfaces		The correct CDIs accepts commands and increments valid word counter CDI A CDI B	Can be performed as part of normal test sequence.
7.2.1.10.3	Verify the CDI accepts and properly responds to: a) normal data from receiver b) inverted data from receiver			GSE/STE to provide the capability to invert the forward link command data.  1's complement of normal data/
7.2.1.10.4	CDI FUNCTIONAL OPERATION			
7.2.1.10.5	Verify the CDI executes commands a) High Level Discretes b) Serial Digital commands			Serial commands verified as part of S/S B, D, H, S tests.  Perform the verification for CDI A&B separately.
7.2.1.10.6	Verify CDI rejects with no execution improper coded commands, as follows: a) incorrect vehicle address b) incorrect hamming code c) not preceded by valid sync/command d) invalid CDI bits  Verify the CDI accepts but does not execute improper coded commands as follows: a) improper discrete bit b) improper serial bit c) improper serial channel bits d) improper operation code bits		CDI valid word counters do not increment CDI A CDI B After detecting error rejects further message until new valid sync word  CDI valid and counting DO increment.  CDI A CDI B USE (special test CMDS) TBD	The first four command types (a,b,c,d) must be preceded by a 48-bit sync command and one valid command..  Serial commands verified as part of individual S/S B, D, H, S tests.
7.2.1.10.7	Verify the DCI A&B accept counter increments properly		The accept counter increments to 255	256 continuous 48-bit commands sent to both A&B.

EXAMINABLE

2.3 - 164

VERIFICATION REQUIREMENTS AND SPECIFICATIONS

NUMBER	REQUIREMENT STATEMENT	SIGNAL ID	CRITERIA AND SPECIFICATIONS	CONDITIONS, CONSTRAINTS, REMARKS
7.2.1.10.8	Verify all CDI commands			Per the ST command list, all commands that execute via CDI must be issued. The DMU must be off for this verification.
7.2.1.10.9	Verify CDIA&B operation independant of DMS power		Verify for DMU A&B pwr on CDI A, CPI B	
7.2.1.10.10	Verify CDIA&B operation independant of DMS oscillator		Part of 7.2.10.9	The DMU TIM and oscillator must be off for this verification. Oscillator is powered by DMU power supply. This test can be verified simultaneously with 7.2.1.10.9
7.2.1.10.11	Verify CDI operation at both input rates		accepts command message	Perform paragraphs 7.23.1.1.1 and 7.2.1.1.2 at 125 BPS and 1000 BPS.
7.2.2	DF-224 COMPUTER			
7.2.2.1	Computer Hardware Verification			Perform the verification for each configuration in Table 7.2.2-1 as specified and repeat 27 steps with EDB B. The same memory units may be used for LMU 0,1,& 2 for this test. Both the primary and redundant input power to the computer must be used.
7.2.2.2	Hardware Load (HWL) Verification			Perform the verification for each Physical Memory Unit (PMU), i.e., 1-6.
7.2.2.3	Verify all Physical Memory Units (PMU) can be hardware loaded as Logical Memory Unit (LMU) ZERO			<p>Constraints:</p> <p>Issue: CPU Reset - ON  HWL - ON  Load Data (255 words)  HWL - OFF  HWL - ON  load Data (255 words)  HWL - OFF  repeat above 3 items as required to load  memor CPU Reset - OFF</p>

EXAMPLE

VERIFICATION REQUIREMENTS AND SPECIFICATIONS

NUMBER	REQUIREMENT STATEMENT	SIGNAL ID	CRITERIA AND SPECIFICATIONS	CONDITIONS, CONSTRAINTS, REMARKS
7.2.2.4	Verify LMU ZERO will:			
	a) Issue TLM requests		a) GSE SW in lock and processes data	
	b) Issue commands		b) Functional verification via TLM response	
	c) Compute vehicle time		c) Proper time word on TLM	
	d) Load other MU under software control		d) Indicates checksum valid	
	e) Dump other MU under software control		e) OBSW contents compare with those loaded by GSE	

EXAMPLE

VERIFICATION REQUIREMENTS AND SPECIFICATIONS

Table 7.2.2-1

<u>Configuration</u>	<u>CPU</u>	<u>IDB</u>	<u>IOU</u>	<u>EDB</u>
1	1	A	1	A
2	2	A	1	A
3	3	A	1	A
4	1	B	1	A
5	2	B	1	A
6	3	B	1	A
7	1	C	1	A
8	2	C	1	A
9	3	C	1	A
10	1	A	2	A
11	2	A	2	A
12	3	A	2	A
13	1	B	2	A
14	2	B	2	A
15	3	B	2	A
16	1	C	2	A
17	2	C	2	A
18	3	C	2	A
19	1	A	3	A
20	2	A	3	A
21	3	A	3	A
22	1	B	3	A
23	2	B	3	A
24	3	B	3	A
25	1	C	3	A
26	2	C	3	A
27	3	C	3	A

EXAMINER

NOTE: EDB selected must match the CIF selected i.e., EDB-A and C/F - B



NUMBER	REQUIREMENT STATEMENT	SIGNAL ID	CRITERIA AND SPECIFICATIONS	CONDITIONS, CONSTRAINTS, REMARKS
7.2.3	ENGINEERING/SCIENTIFIC TAPE RECORDER (ESTR)			<p>Constraints: For each tape recorder separate records must be maintained for each of the events BOT, EOT and operation hours.</p>
7.2.3.1	Tape Recorder (TR) Command Verification			<p>Allow at least 5 seconds between TR commands. The command check includes the don't care bits of the TR commands.</p>
7.2.3.2	Verify TR goes to standby with power on command a) TR #1 Cmd b) TR #2 Cmd c) TR #3 Cmd	Tape Record Pressure Monitor goes from no value to value Monitor indicates standby		<p>Initial Condition: Tape recorder in "OFF" state.</p>
7.2.3.3	Fast forward to EOT for TR #1, #2, #3	Power on Tape position monitor increases EOT flag set		<p>Perform before TRI validation begins. This sets tape position.</p>
7.2.3.4	Fast reverse to BOT for TR #1, #2, #3	Power on Tape position monitor decreases BOT flag set		<p>At end of this test, tape is stacked and ready for TRI testing.</p>
7.2.3.5	Verify TR ability to record engr data at 4 kbps and 32 kbps • Perform test for TR#1, #2, #3 • Verify NTC at both data rates	Monitors: • TR standby to operate • Position monitor increasing • When NTC commands are sent during record sequence process is not interrupted		<p>Initial Conditions: Track 1; BOT Record Sequence:</p> <ol style="list-style-type: none"> <li>1. Record 4 kbps engr data for 8 min and stop.</li> <li>2. At 4 min into record verify NTC commanding.</li> <li>3. Record 32 kbps engr data for 8 min and stop.</li> <li>4. At 4 min into record verify NTC commanding.</li> </ol>

2.3 - 168

EXAMINER

VERIFICATION REQUIREMENTS AND SPECIFICATIONS

NUMBER	REQUIREMENT STATEMENT	SIGNAL ID	CRITERIA AND SPECIFICATIONS	CONDITIONS, CONSTRAINTS, REMARKS
7.2.3.6	Verify TR ability to record science data at 4 kbps and 32 kbps <ul style="list-style-type: none"> <li>• Perform test for TR#1, #2, #3</li> <li>• Verify NTC at both data rates</li> </ul>	Monitors:	<ul style="list-style-type: none"> <li>• TR standby to operate</li> <li>• Position monitor increasing</li> <li>• When NTC commands are sent during record sequence process is not interrupted</li> </ul>	<ul style="list-style-type: none"> <li>a. Initial Conditions: Start on tape where section 7.2.3.3 finished.</li> <li>b. Science data will be fill-packets from SI C&amp;DH since at this point SI's are not installed</li> <li>c. Record sequence:                             <ol style="list-style-type: none"> <li>1. Record 4 kbps science data for 8 min and stop.</li> <li>2. At 4 min into record verify NTC commanding.</li> <li>3. Record 32 kbps science data for 8 min and stop.</li> <li>4. At 4 min into record verify NTC commanding.</li> <li>5. Record 1.024 Mbps science data to BOT.</li> <li>6. At 2 min into record verify NTC commanding</li> </ol> </li> </ul>
7.2.3.7	<ul style="list-style-type: none"> <li>a) Verify TR#1, #2, #3 can reproduce data from 4 kbps, 32 kbps and 1.024 Mbps record</li> <li>b) Verify NTC commands</li> </ul>	Data readout corresponds to data recorded	Reproduce sequence to be interrupted	Initial Conditions: Trace 2 BOT send NTC command halfway through reproduce sequence. Send NTC commands halfway through the reproduce sequence.
7.2.3.8	Verify each recorder (TR#1, #2, #3) can be designated as the safe mode tape recorder, and records engr data at 4 kbps adn reproduces at 1.024 Mbps	<ul style="list-style-type: none"> <li>a) Records at 4 kbps on track commanded at last tape motion</li> <li>b) Records until end of sequence reached or safe mode off is rec'vd</li> <li>c) Cannot be stopped by DIU serial command interface on power-off discrete interface</li> </ul>	Can be performed as part of safe mode testing Section 9.0	
7.2.3.9	Verify record capability of 10.4 hours (continue record sequence) for TR#1, #2, #3.			Verification can be extrapolated from record/produce sequence Sections 7.2.3.3 through 7.2.3.5

2.3 - 169

EXAMINABLE

VERIFICATION REQUIREMENTS AND SPECIFICATIONS

NUMBER	REQUIREMENT STATEMENT	SIGNAL ID	CRITERIA AND SPECIFICATIONS	CONDITIONS, CONSTRAINTS, REMARKS
7.2.3.10	Verify tape position monitor increments EOT and decrements to BOT a) TR #1 b) TR #2 c) TR #3	At BOT tape position monitor is 001 at EOT tape position is 127	Can be verified during record/reproduce sequence.	
7.2.3.11	Verify automatic track switch from track 1 to track 2 at EOT a) TR #1 b) TR #2 c) TR #3		Can be verified during record sequence in Section 7.2.3.5.	
7.2.3.12	Verify erase only occur on track being recorded		Implied when recorded data is reproduced over tracks 1 and 2.	
7.2.3.13	Verify fast forward a) does not erase b) causes tape position monitor to increment			
7.2.3.14	Verify fast erase a) does not erase b) causes tape position monitor to increment			
7.2.3.15	Verify BER less than 1 in 10*6 averaged over 10*9 bits		Verified if SATS software is available otherwise verified at ST level. <ul style="list-style-type: none"> <li>The DMU/DIUI message allows for 256 request channel addresses for each A or B DIU element (Reference Table 7.2.4-1 details).</li> <li>This is a DIU power verification test sequence and can be verified</li> <li>DIU input/output functional verification testing occurs as an ongoing function</li> </ul>	

2.3 - 170

EXAMPLE

VERIFICATION REQUIREMENTS AND SPECIFICATIONS

NUMBER	REQUIREMENT STATEMENT	SIGNAL ID	CRITERIA AND SPECIFICATIONS	CONDITIONS, CONSTRAINTS, REMARKS
7.2.4	DATA INTERFACE UNIT (DIU) VERIFICATION			
7.2.4.1	<p>DIU Power Switching/Echo Check Verification</p> <p>1. Configure all B-Side DIU</p> <ul style="list-style-type: none"> <li>• Configure all B-Side logic elements</li> <li>• CMD via A-Side DIU</li> </ul> <p>2. Configure all A-Side DIUs to Primary Input Power OFF, B-Side DIUs to Primary Input Power ON, command via B-Side logic elements</p> <p>3. Repeat above two sequences utilizing Redundant Input Power as power sources to DIUs</p>	<ul style="list-style-type: none"> <li>• Echo check failed</li> <li>• Echo check passed</li> </ul>	<p>1. Initial Conditions:</p> <p>a. All A-Side elements of DIUs to Primary Input Power ON (initial turn-on of DIUs selects all A-Side DIUs).</p> <p>b. All B-Side elements of DIU are echoed back as Bits 11-20 of responses from DIU for comparison check in a DIUI register.</p> <p>Perform this check for all DIUs.</p> <p>Bits 1-10 of commands to DIU are echoed back as Bits 11-20 of response from DIU for comparison check in a DIUI register.</p>	

EXAMINABLE

2.3 - 171

Table 7.2.4-1 DIU Input and Output to User Interfaces

SIGNAL DESCRIPTION <u>COMMANDS</u>	NUMBER OF SIGNALS				DIU ADDRESSES		
	CROSS-STRAPPED (A/B)	NON CROSS-STRAPPED		A/B	OCTAL	A/B	DECIMAL
		A	B		A,B		A,B
POWER PULSE DISCRETE (24ms, +28 Vdc)	144	48	48	500-537 617-776	540-616 777	320-351 399-510	352-398 511
SERIAL CHANNELS (16 bit message)		20	20	-	400-423	-	256-275
<u>DATA</u>					20-36 41-54	0-15 45-174	16-30 33-44
ANALOG CHANNELS (8 bits, 0 TO 5 Vdc)	185**	30**	30**	0-17 55-256 260-326	327-331	176-214	215-217
BI-LEVEL BITS (group of 8 bit words)	120 (15 WORDS)	30 (3.75 WDS)	44* (5.5 WDS)	341-357	332-340*	225-239	218-224
SERIAL CHANNELS (8, 16 bit per message)			16	-	360-377	-	240-255

\*OCTAL ADDRESSES 332-340 ARE ASSIGNED TO SEVEN BI-LEVEL WORDS, 56 TOTAL BITS. ONE AND A HALF OF THESE WORDS ARE USED FOR INTERNAL KIU FUNCTIONS (OCTAL ADDRESS 337 AND THE CENTER FOUR BITS OF ADDRESS 340) AND ARE NOT AVAILABLE TO THE USER.

\*\*30 NON CROSS-STRAPPED AND 185 CROSS-STRAPPED ANALOG DATA CHANNELS ARE AVAILABLE TO THE USER. THREE ADDITIONAL ANALOG DATA CHANNELS WITH OCTAL ADDRESSES 37, 40 AND 257 ARE WIRED INTERNALLY IN THE DIU FOR HEALTH CHECKS AND ARE NOT AVAILABLE TO THE USER.

VERIFICATION REQUIREMENTS AND SPECIFICATIONS

NUMBER	REQUIREMENT STATEMENT	SIGNAL ID	CRITERIA AND SPECIFICATIONS	CONDITIONS, CONSTRAINTS, REMARKS
7.2.4.2	<p><b>DIU COMMAND/DATA INPUT VERIFICATION</b></p> <p>a) Verified in conjunction with other tests in this document. (Reference remarks 1 &amp; 2 and Table 7.2.13-1)</p> <p>b) Spare IDU ports must also be commanded to verify that (no response from users) these ports are commanded properly.</p>	<p>All commands/data requests processed by the DIU must pass the following checks:</p> <p>a) Parity check (odd)</p> <p>b) Clock Pulse Count (DIU received 37 or less clocks for each data request)</p> <p>c) Clock Pulse Count (DIU received 37 or less clocks for each data request)</p> <p>d) Serial Check Code (Serial Digital Command only)</p>	<p>The DIU accepts/processes High Level Discretes and Serial Digital Commands from the DMS and issues these commands to the users. It also accepts/processes Serial Digital, Bi-Level, Analog Data Requests from the DMS and accepts/processes Serial, Bi-Level and Analog Data respectively from the users.</p>	
7.2.4.3	<p><b>DIU High-Level Discrete Command Execution Verification</b></p> <p>Initiate Execution Verification Discrete Command and a Serial Digital Command during the same execute time period</p>	<p>Both commands are executed</p>	<p>DIU contains separate logic for simultaneous execution of a High-Level Discrete and a Serial Digital Command.</p>	
7.2.4.4	<p><b>DIU Precision Voltage Monitor Verification</b></p> <p>Initiate commands to read out internal test voltages of each DIU.</p>	<p>Verify proper readouts of these voltages</p>	<p>Each DIU generates 3 precision test voltages</p> <p>0Vdc ± 20 mV 2.5 Vdc ± 20 mV 4.9 Vdc ± 20 mV</p>	
7.2.4.5	<p><b>DIU Temperature Monitor Verification</b></p>	<p>This temperature readout of all ST DIUs (Element A and B) will be part of normal telemetry readout for ground analysis as required.</p>		

2.3 - 173

VERIFICATION REQUIREMENTS AND SPECIFICATIONS

NUMBER	REQUIREMENT STATEMENT	SIGNAL ID	CRITERIA AND SPECIFICATIONS	CONDITIONS, CONSTRAINTS, REMARKS
7.2.5	6.144 MHz OSCILLATOR			
7.2.5.1	Verify oscillator A on B off command	15.2 ro 17.8 VDC		
7.2.5.2	Verify oscillator A off B on command			
7.2.5.3	Verify oscillator frequency, and amplitude at Station 240, Intermittent Connectors 24J7 and 24J8		Frequency: 6.144 MHz Amplitude: $1.3 \pm 0.3$ VRMS	Both A & B oscillators to be measured.
7.3	ON BOARD SOFTWARE (OBSW)			
7.3.1	TELEMETRY PROCESSING			
7.3.1.1	Verify ability to output: <ul style="list-style-type: none"> <li>• Minor frame sync</li> <li>• Major frame sync</li> <li>• Format ID code</li> <li>• Minor Frame counter</li> <li>• Master Timing Pulse</li> </ul>			Verified during normal functional testing.
7.3.1.2	Verify ability to switch bit rates telemetry stream		Rate change occurs at end of frame.	SW changes rate of TFC and outputs correct number of TLM requests, verify 0.5, 4.0 32 kbps rate changes
7.3.1.3	Verify ability to switch from one format to another <ul style="list-style-type: none"> <li>a) Programmable to fixed</li> <li>b) Programmable to programmable</li> <li>c) Fixed to programmable</li> </ul>		a. and b. change at end of major frame c. changes after 2-2.5 sec delay after CMD receipt	Two programmable formats must be contained in the DF-224.
7.3.1.4	Verify ability to accept requested data from FIFO in DIUI.			Data used by OBSW for computational purposes. Reference paragraph 7.2.1.3.1.
7.3.1.5	Verify ability for multiplexed memory dump with normal telemetry		Read out shall be between beginning and end locations specified by CMD	

2.3 - 174

NUMBER	REQUIREMENT STATEMENT	SIGNAL ID	CRITERIA AND SPECIFICATIONS	CONDITIONS, CONSTRAINTS, REMARKS
7.3.1.6	Verify full frame dump of telemetry			Replaces normal TLM bit stream
7.3.2	<b>COMMAND PROCESSING</b>			
7.3.2.1	<b>Real Time Commands</b> Verify:		<ul style="list-style-type: none"> <li>• RTC's have priority over block loads</li> <li>• RTC's immediately issued without interrupting SPC execution</li> <li>• Indication of rejection on Telemetry</li> </ul>	
	<ul style="list-style-type: none"> <li>• Hardware and Software single and multiple word commands</li> <li>• RTC Software commands rejected if intended execution is still busy processing the previous command</li> </ul>			
7.3.2.2	<b>Stored Program Commands</b> Verify the ability to process:		<p>Commands executed at specified absolute and delta times</p> <p>HLD not issues at 5 pc defined</p>	<p>Can be performed as part of Pcs (Sect. 8.0) and Safemode (Sectin 9.0) testing.</p> <p>Load HLD's with less than 50 ms separation</p>
	<ul style="list-style-type: none"> <li>• Hardware single and multiple word commands</li> <li>• Software single and multiple word command</li> <li>• Execute both hardware and software commands at absolute and delta times</li> <li>• High level discreties not issued more than one ever 50 ms</li> </ul>			
7.3.2.3	<p><b>Memory Block Loads Verify:</b></p> <p>a) Block load capability of 1 and 62 words</p> <p>b) Block load check sum test for pass check sum and fail check sum conditions</p> <p>c) Repeat b) with checksum test disabled</p>		<ul style="list-style-type: none"> <li>• Data was properly loaded</li> <li>• Indication of check sum test pass fail. Failed checksum block not executed</li> <li>• Block loaded regardless of checksum status.</li> </ul>	<ul style="list-style-type: none"> <li>• Can used memory dump function of TLM to verify block load</li> <li>• Simulate failed check sum case by transmitting wrong checksum in block load</li> <li>• Use one word data load to diable/enable check sum test.</li> </ul>

2.3 - 175

REPLACEMENT



VERIFICATION REQUIREMENTS AND SPECIFICATIONS

NUMBER	REQUIREMENT STATEMENT	SIGNAL ID	CRITERIA AND SPECIFICATIONS	CONDITIONS, CONSTRAINTS, REMARKS
7.3.3	SOFTWARE PROCESSING			This Section tests the software functions/algorithms performed by the DF-224.
7.3.3.1	Pointing Control System (PCS)			Verification of PCS routines is contained in Sec. 8.
7.3.3.2	Sensor Data Processing			Verification of Sensor Processing is contained in Sec. 8 and 9.
7.3.3.4	PCS Hardware Commanding		Verification of safemode processing is contained in Section 9.	Verification of PCS hardware commanding is contained in Sec. 8 and 9.
7.3.3.5	Safemode Processing	(TBD)	This test sequence covers EPS functions performed other than used in Safemode	
7.3.3.6	Electrical Power Subsystem (EPS) Status Processing (TBD)			
7.3.3.7	Vehicle Elapsed Time Word a) Verify time is updated by software b) Verify word can be set with one second resolution		a) Vehicle time on TLM changed with 125 ms LSB. b) Time word resets	
7.3.3.8	PIT Word Processing a) Verify that OBSW receives and responses to SI C&DH PIT Table Data b) Verify SI C& DH commands can be inhibited c) Verify SSM PIT Table processing use one word data load to Activate/deactivate processing  d) Verify PIT Format		a1) Performs PCS maneuvers as specified a2) PIT Table verified on Telemetry b) PCS does not respond to PIT commsnds C. PIT appears on TLM	Can be performed as part of PCS (Section 9.0) Tests  Use one word data load to inhibit response to SI C&DH PIT maneuver commands When computer is powered on PIT processing is inhibited. Requires one word data load to activate processing  Verification defined in Section 7.4.1.2.1.

2.3 - 176

EXHIBIT

VERIFICATION REQUIREMENTS AND SPECIFICATIONS

NUMBER	REQUIREMENT STATEMENT	SIGNAL ID	CRITERIA AND SPECIFICATIONS	CONDITIONS, CONSTRAINTS, REMARKS
7.3.3.9	<p>Special Control Words</p> <p>a) Solar Array electronics Selection. Verify both primary and secondary drives can be selected</p> <p>b) Tape Recorder - Verify software command of the following configurations:</p> <ul style="list-style-type: none"> <li>• Mode Standby/operate</li> <li>• Clock Select TFC/COM</li> <li>• Record/Playback</li> <li>• Tape Recorder Assign</li> </ul> <p>c) Memory Protect Verify that portions of each memory unit can be protected/unprotected</p>	<p>a) Drive selected memory location is set</p> <p>c) Memory dump of that portion of memory protected indicates a change/no change appropriate into it.</p>	<p>This capability will be mainly verified in Sections 8 and 9, except as noted here. Verify both primary</p> <p>Can be performed as part of tape recorder tests section 7.2.11.</p> <p>Requires protecting a portion of memory, then attempting to write into it, then unprotecting that portion and writing</p>	
7.4	DMS INTERFACES OTHER ELEMENTS			
7.4.1	SUPPORT MODULE TO SI C&DH INTERFACE VERIFICATION			<p>1. The support module controls all command/data (including PIT) transfers between the support module and SI C&amp;DH via clocks and software frequencies resident in the support module (VIA the Data Management Subsystem). All modules at interface are redundant but not cross-strapped except the SSM CDI high level discretes and the SI C&amp;DH PCU.</p>
7.4.1.1	Verify Power to SI C&DH Power Interface	<p>Power 1 goes to SI C&amp;DH Power Bus A Power 2 goes to SI C&amp;DH Power Bus B</p>		
7.4.1.2	DMS A to CU/SDFA Interface			

2.3 - 177

EXHIBIT

VERIFICATION REQUIREMENTS AND SPECIFICATIONS

NUMBER	REQUIREMENT STATEMENT	SIGNAL ID	CRITERIA AND SPECIFICATIONS	CONDITIONS, CONSTRAINTS, REMARKS
7.4.1.2.1	Verify MTP receipt by the SI C&DH to the following rates: a) 0.5 sec b) 5.0 sec c) 4.0 sec		a) Telemetry is dynamic b) &c) Telemetry dynamic and MTP 4.5 sec flag is not set in SI C&DH telemetry	This test can be combined with para 7.4.1.2.2
7.4.1.2.2	Verify SI C&DH real time ENG TLM received by DMS in the following formats: a) 4 Kbps, Programmable b) 32 Kbps, Programmable c) .5 Kbps, Programmable d) 4 Kbps, Fixed e) .5 Kbps, Fixed		SI C&DH telemetry data readout corresponds to required formats as initiated by ground commands.	
7.4.1.2.3	Verify 1.024 MHZ clock receipt by the SI C&DH		The 1.024 MHS loss of clock bit is not set in SI C&DH Eng TLM	This test can be performed by switching to TIM B and verifying loss of clock bit is set.
7.4.1.2.4	Verify that the SI C&DH receives 27 bit commands from the CDI A  Verify that the SI C&DH receives 16 bit commands from the DIU #5		Telemetry monitors indicate proper function response for SI C&DH commands Telemetry monitors indicate proper function response of SI C&DH commands	Send at least one serial digital, one discrete, and one computer command.  Send at least one serial digital, one discrete, and one computer command.
7.4.1.2.5	Verify that the SM receives and processes SI C&DH real time Science Data at the following data rates: a) 4 Kbps b) 1.024 Mbps		Receipt of fill-packets by ground station.	Real time science data will be simulated by SIC & DH fill-packets.
7.4.1.2.6	Verify that the SI C&DH Science data can be recorded on teh Science tape recorder at the following data rates: a) 4Kbps b) 32 Kbps c) 1.024 Mbp		Tape recorder playback reproduces the SI C&DH fill-packets.	Real time science data will be simulated by SIC & DH fill-packets.

2.3 - 178

VERIFICATION REQUIREMENTS AND SPECIFICATIONS

NUMBER	REQUIREMENT STATEMENT	SIGNAL ID	CRITERIA AND SPECIFICATIONS	CONDITIONS, CONSTRAINTS, REMARKS
7.4.1.3	Verify CDI A and b high level discretes are received by SI C&DH PCU.	SI C&DH Power Buses Control	Control on and off.	
7.4.1.4	Interface DMS B to CU/SDFB			
7.4.1.4.1	Verify MTP receipt by the SI C&DH at the following rates a) .5 sec b) 5 sec c) 4 sec		a) Telemetry is dynamic b) & c) Telemetry dynamic and MTP 4.5 sec flag is set in SI C&DH telemetry	This test can be combined with para 7.4.1.4.2.
7.4.1.4.2	Verify SI C&DH real time ENG TLM received by DMS in the following formats: a) 4 Kbps, Programmable b) 32 Kbps, Programmable c) .5 Kbps, Programmable d) 4 Kbps, Fixed e) .5 Kbps, Fixed	SI C&DH telemetry data readout	SI C&DH telemetry data readout compared to required formats as initiated by ground commands.	
7.4.1.4.3	Verify 1.024 MHz clock receipt by the SI C&DH		The 1.024 MHz clock is not set in SI C&DH Eng TLM. bit is set.	This test can be performed by switching to TLM B and verifying loss of clock.
7.4.1.4.4	a) Verify that the SI C&DH receives 27 bit commands from the DIU #5  b) Verify that the SI C&DH receives 16 bit commands from the DIU #5		Telemetry monitors indicate proper function response of SI C&DH commands  Telemetry monitors indicate proper function response of SI C&DH commands	Send at least one serial digital, one discrete, and one computer command.  Send at least one serial digital, one discrete, and one computer command.
7.4.1.4.5	Verify that the SM receives and processes SI C&DH real time Science Data at the following data rates: a) 4 Kbps b) 1.024 Mbps		Receipt of fill-packets by ground station.	

2.3 - 179

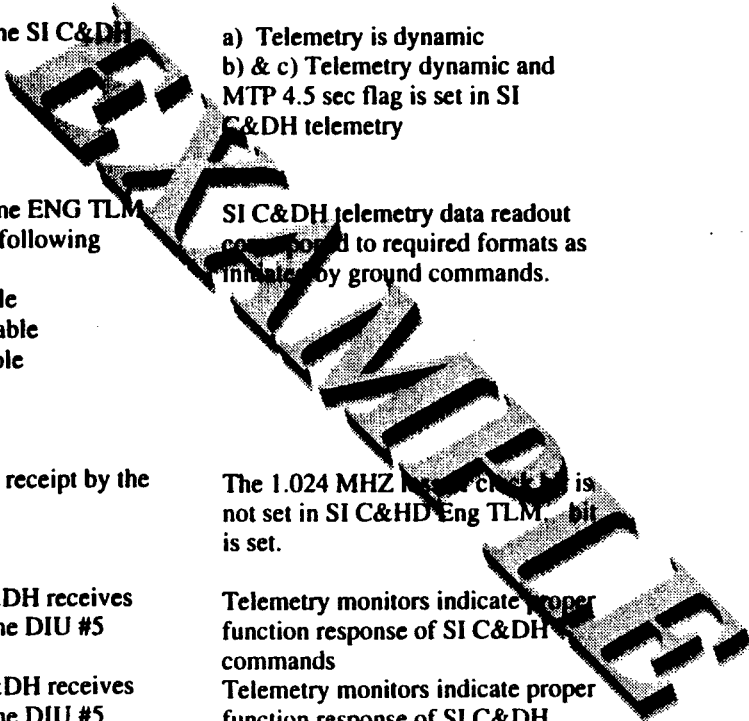

VERIFICATION REQUIREMENTS AND SPECIFICATIONS

NUMBER	REQUIREMENT STATEMENT	SIGNAL ID	CRITERIA AND SPECIFICATIONS	CONDITIONS, CONSTRAINTS, REMARKS
7.4.1.4.6	Verify that the SI C&DH Science data can be recorded on teh Science tape recorder at the following data rates. a) 4 Kbps b) 32 Kbps c) 1.024 Mbps	Tape recorder playback reproduces the SI C&DH fill-packets.		The test could be performed as follow: Initial condition Pit transfered with initiate safing bit zero. Then transfer safing bit = 1 and SI C&DH will initiated payload safing sequence.
7.4.1.4.7	Verify that SI C&DH is receiving from SM PIT	TBD		
7.4.1.4.8	Verify that SM is receiving SI C&DH PIT	SI C&DH Pit on Eng TBD		
7.4.2	<b>DMS TO SOLAR ARRAY (SA) INTERFACE VERIFICATION</b>  Verify that the DMS Provides interface capabilities for all commands/engineering data to/from the SA Electronic Control Assembly (ECA)			<ol style="list-style-type: none"> <li>1. The ECA controls/monitors all functions of the two solar array wings via the Deployment Control Electronics (DCE) and the Solar Array Drive Electronics (SADE). The DCE is used for deployment/retrieval of both SA Wings. The SADE controls the position of each SA Wing independantly by operating individual orientation motors for each wing, monitoring the angular position of each SA wing and monitoring the temperatures of the Solar Array Drive Mechanism (SADM) of each wing. During normal in-orbit operations only the SADE is active.</li> <li>2. The DMS issues Serial Digital Commands and High Level Discrest (HLD) commands to the ECA. The command interface is redindantly provided by two CDI modules (A &amp; B) in the DMU</li> </ol>

EXAMINER

MSFC-HDBK-2221  
 February 1994

2.3 - 180

VERIFICATION REQUIREMENTS AND SPECIFICATIONS

NUMBER	REQUIREMENT STATEMENT	SIGNAL ID	CRITERIA AND SPECIFICATIONS	CONDITIONS, CONSTRAINTS, REMARKS
				<p>Each ECA can accept commands for both SA Wings from the DF-224 Computer, the PSEA or directly from the ground. The DMS receives analog, bi-level and serial digital data from the ECA via DIU for output on telemetry and input to the DF-224. The ECA also provides directly (bypasses DIU) contingency bi-level status data and failure flags to the Pointing Safe Electronics Assembly (PSEA) for use in control of the SA position when the ST is in a Safe Mode.</p>
7.4.2.1	Command Interface Verification			
7.4.2.1.1	DCE Command Interface Verification. Transmit all DCE commands in sequence to the DCE (See Remark #2)	Verify proper response of DCE to the specific commands, via telemetry.		<ol style="list-style-type: none"> <li>1. All DCE commands (HLDs and Serial) are ground generated commands only and are utilized for initial deployment of the SA Wings.</li> <li>2. An incorrect command will cause automatic switch-off of the DCE.</li> </ol>
7.4.2.1.2	SADE Command Interface Verification			
	1. OLD Command Verification: Transmit (TBD) OLD commands to SADE.	Verify proper response of SADE to the specific commands on TLM.		<p>All SADE commands are HLDs consisting of wing position commands and control commands for the OLD on each wing. The OLD is used to protect the bearings on the SADM from excessive loads during launch and are executed (by ground command only) to free the SADM bearings during deployment of the SA wings after launch.</p>
	2. Wing Position Command Verification: a) Transmit (TBD) wing position commands via Forward Link Command capabilities.	Verify proper response of SADE to these commands on TLM.		<p>Wing position commands can be initiated by the DF-224 Computer, the PSEA or from the ground. The CMD Module must not be in Bypass or Diag. Mode as this would inhibit DF-224 issued commands or STOCC ground initiated commands to be processed by the DF-224 Computer. CDI also has the capability to issue ground commands as special commands to the SADE.</p>

EXAMINER

2.3 - 181

VERIFICATION REQUIREMENTS AND SPECIFICATIONS

NUMBER	REQUIREMENT STATEMENT	SIGNAL ID	CRITERIA AND SPECIFICATIONS	CONDITIONS, CONSTRAINTS, REMARKS
7.4.2.1.2 (con't)	b) Transmit (TBD) wing position commands via teh DF-224 command capability to the SADE.	Verify proper response of SADE to these commands on TLM.		
	c) Configure hardware via ground control to Safe Mode wherein Pointing Safemode wher in PSEA outputs wing position commands (TBD) [REDACTED]	Verify proper response of SADE to these commands on TLM.		PSEA can issue only a subset of wing position as compared to normal operating conditions.
7.4.2.2	<b>Data Interface Verification</b>			
	1, Analog and Bi-Level Data (DCE to DMU DIUI)			The DCE and SADE provide analog, bi-level and serial digital data to the DMS via a DIU. The SADE/PSEA data interface is independent of the SADE/DIU interface (wing position data is routed directly from SADE to PSEA). The analog and bi-level data are temperature data and operating status conditions. The serial digital data provided by SADE are two 16-bit words (one for each wing) which indicate wing position and status information of the SA wings.
	This data is routed back via DIU in response to commands (Reference para 7.4.2.1) to DCE and subsequently read out via telemetry links to ground.			
	2. Analog, Bi-Level and Serial Data (SADE #1, 2, to DMU DIUI)			Verify data inputs from Wings #1 and #2 to DMU.
	3. Wing Position, Status and Failure Data (Bi-Level Data - SADE to PSEA) Configure ST via ground command to Safemode wher in SADE outputs Bi-Level Data directly to PSEA	Verify wing position data and status information correspond with expected data		Verify data inputs from Wings #1 and #2 to PSEA.

EXAMINER

**VERIFICATION REQUIREMENTS AND SPECIFICATIONS**

NUMBER	REQUIREMENT STATEMENT	SIGNAL ID	CRITERIA AND SPECIFICATIONS	CONDITIONS, CONSTRAINTS, REMARKS
--------	-----------------------	-----------	-----------------------------	----------------------------------

**7.4.3 DMS TO OTA INTERFACE VERIFICATION**

**Verify Interface Frequencies, Timing and Sync Pulses, Commands, Data Requests, Enable Gates from the OTA to the DMS**

**7.4.3.1**

**Timing Signals and Sync Pulse Verification:**  
**Test Conductor during SSM Systems test will initiate these signals (including redundant signals) via the Clock-Pulse Verification Panel (Part of the Spacecraft Interface Verification Set)**

**The appropriate lines on Connectors 29J3 and 29J4 at Station 299 will be checked/monitored via breakout boxes for these signals (see Remarks #2 and #3)**

**These differential signals consist of 1.024 MHz clock signals, 40 Hz sync signals, major and minor fram sync signals.**

**During SSM/ST Systems level tests the proper operation of equipments and signal transfers across the OTA Interface will verify the SSM moted timing/sync signals.**

**PRELIMINARY**



## 8.8 COMPATIBILITY TEST

A System level test shall be devised to demonstrate integrated functioning of the flight hardware and software scenario. The configuration, including onboard computer configured for flight as allowed by ground simulation and hardware availability constraints. This test shall be run as part of each functional test (i.e., ambient, post-acoustic, thermal vacuum/thermal balance, and pre-ship).

### 8.8.1 Compatibility Test Objectives.

The following objectives shall be satisfied:

1. Demonstrate acceptable multiple SI and system interaction under orbital conditions.
2. Verify acceptable system performance under maximum flight conditions.

### 8.8.2 Compatibility Test Requirements.

Test requirements based on the preceding objectives have been developed to demonstrate that the flight article will operate as an integrated system. The testing shall consist of mission oriented orbits modified to include an expanded version of the VAD noise that include noise sensitive/noise producing test segments. The compatibility test shall:

- Be configured to include the WF/PC and one axial, the WF/PC and several axial SIs, and the WF/PC and each mission pair of axial SIs in the operate mode depending on the requirements under test. All subsystems along with its DIU shall be supporting the involved mission simulations.
- Demonstrate FGS astrometry with the other two FGSs in fine lock and an SI in operate mode.
- Demonstrate the following performance:
  - Thermal
  - Electro/Mechanical
  - EMI
  - Communication
  - Timing

- Data Management Compatibility
- Verify the absence of detrimental interactions while each element under evaluation is in its maximum noise sensitive configuration and each interacting element is put in each of its noise producing configurations. The following combinations of subsystems shall be operated as part of the mission simulation:
  - All subsystems, all SIs in combination of two to five, three FGSs with OTA EP/TCS and DIU-1;
  - All subsystems, no SIs, two FGSs, ACS, EP/TCS and DIU-1;
  - All subsystems, no SIs, two FGSs, ACS, EP/TCS.
- Demonstrate all distinct data acquisition, target acquisition, and scan modes.
- Demonstrate recovery from temporary operational failures including:
  - Loss of Lock
  - Bright Object Detection
  - Software Safing Including SIC&DH Failure
- Verify acceptable performance for maximum expected flight conditions including:
  - Critical timing within the DMS
  - Telemetry format and rate reconfiguration
  - Maximum bus traffic
  - Maximum competition for the tape recorder
  - Maximum command execution rates
  - High and low voltage limits

Test orbits shall be designed to allow the preceding requirements verifications. Equipment constraints relative to the TV environments shall be incorporated. The latest versions of the SCT Combination Matrices shall be used as a guide in the development of the test orbits.

### 8.8.3 Test Constraints.

All test constraints defined for testing shall be observed.

## **2.4**

# **VERIFICATION REQUIREMENTS COMPLIANCE DOCUMENT**

## **2.4.1 INTRODUCTION**

The Verification Requirements Compliance Document provides the evidence of compliance to each Level I through Level IV design, performance, safety, and interface requirement and to each Verification Requirement and Specifications Document (VRSD) requirement. The compliance document can show a flowdown of requirements to the VRSD as shown in the example or compliance may be defined in one document for program requirements and in a second document for VRSD requirements. The example Verification Requirements Compliance Document was prepared by MSFC's Systems Analysis and Integration for the Small Expendable Deployer System, Second Mission (SEDS-2) Program.

## **2.4.2**

# **VERIFICATION REQUIREMENTS COMPLIANCE DOCUMENT**

## **EXAMPLE**

**THIS PAGE INTENTIONALLY LEFT BLANK**

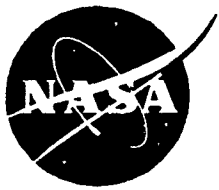

National Aeronautics and  
Space Administration

---

George C Marshall Space Flight Center  
Marshall Space Flight Center, Alabama 35812

**SMALL EXPENDABLE DEPLOYER SYSTEM  
SECOND MISSION**

**(SEDS-2)**

**VERIFICATION REQUIREMENTS  
COMPLIANCE DOCUMENT**

**EXAMPLE**

2.4 - 5

**EXAMPLE**

THIS PAGE INTENTIONALLY LEFT BLANK



TABLE OF CONTENTS

PARAGRAPH PAGE

LIST OF ACRONYMS .....2.4-9

SECTION I GENERAL

1.0 INTRODUCTION .....2.4-11

1.1 PURPOSE .....2.4-11

1.2 SCOPE .....2.4-11

1.3 APPLICABLE DOCUMENTS .....2.4-12

1.4 FORMAT .....2.4-12

1.4.1 SRD/IRD REQ .....2.4-12

1.4.2 CEI REQ.....2.4-12

1.4.3 VRSD REQ.....2.4-13

1.4.4 REQUIREMENT STATEMENT .....2.4-13

1.4.5 COMPLIANCE METHOD.....2.4-13

1.4.6 COMPLIANCE DATA CONTACT .....2.4-13

2.4-7

**EXAMINABLE**

1.4.7 COMPLIANCE DATA .....2.4-13  
1.4.8 NON-CONFORMANCES.....2.4-14  
1.4.9 COMMENTS/REMARKS.....2.4-14

SECTION II VERIFICATION COMPLIANCE MATRIX

**EXAMPLE**

## LIST OF ACRONYMS

CEI	Configuration End Item
DR	Discrepancy Report
IRD	Interface Requirements Document
NCR	Non-Conformance Report
SDR	Software Discrepancy Report
SRD	System Requirements Document
VRSD	Verification Requirements and Specification Document

**EXAMPLE**

# EXAMPLES

## SECTION I GENERAL

## 1.0 INTRODUCTION

### 1.1 Purpose

The purpose of this document is to:

(1) identify the flow-down of SEDS-2 requirements from the SEDS-2 Systems Requirements Document (SRD), MSFC-RQMT-2233 and SEDS-2/DELTA II Interface Requirements Document (IRD), MSFC-SPEC-2235 down to the SEDS-2 Deployer System End Item Specification, MSFC-SPEC-2234, and the SEDS-2 Verification Requirements and Specifications Document (VRSD), MSFC-RQMT-2240, and

(2) to show compliance to the lower level deployer system requirements so an assessment of these compliances will show compliance to the upper level system requirements.

### 1.2 Scope

The SEDS-2 Verification Compliance Document states in matrix form how the system level requirements and the interface requirements are branched down to the deployer system end item requirements and on down to the SEDS-2 VRSD requirements for the deployer system. The matrix then identifies which verification methods were used to verify the requirements and the verification report(s) that show compliance to the requirements. Once the lower level requirement compliances are identified, the compliances can be branched back up to the system level requirements to show compliance for the deployer system portion of SEDS-2.

### 1.3 Applicable Documents

The following documents form a part of this specification to the extent specified herein.

MSFC-RQMT-2240	Small Expendable Deployer System, Second Mission (SEDS-2), Verification Requirements and Specifications Document (VRSD)
MSFC-RQMT-2233	Small Expendable Deployer System-2, System Requirements Document

MSFC-SPEC-2234

Small Expendable Deployer System-2, Deployer System End Item Specification

MSFC-SPEC-2235

SEDS-2/DELTA II Interface Requirements Document

#### 1.4 Format

Section II of this document contains the verification compliance matrix. A description of each column of the matrix is provided in the subsequent paragraphs.

##### 1.4.1 SRD/IRD REQ

This column contains the paragraph number of the requirement taken from the SEDS-2 SRD and/or the SEDS-2 IRD. Requirements from the SRD are coded with an "S" (e.g. S1.0). Requirements from the IRD are coded with an "I" (e.g. I1.0).

##### 1.4.2 CEI REQ

This column contains the paragraph number of the requirement taken from the SEDS-2 Deployer System End Item Specification.

##### 1.4.3 VRSD REQ

This column contains the paragraph number of the requirement taken from the SEDS-2 Verification Requirements and Specifications Document (VRSD).

**EXAMINER**

#### 1.4.4 REQUIREMENT STATEMENT

This column defines the requirement as stated in the SRD, IRD, CEI, or VRSD. The SRD requirements and the CEI requirements are stated the same with the exception that in the CEI the term "SEDS-2" is replaced by the term "SEDS-2 DS" (meaning SEDS-2 deployer system). The SRD requirement will not be repeated unless the requirement is different from that stated in the CEI.

#### 1.4.5 COMPLIANCE METHOD

This column defines the verification method used to satisfy the particular requirement:

T - Test  
A - Analysis  
I - Inspection

S - Similarity  
D - Demonstration  
V - Validation of Records

R - Review of Design Documentation  
N/A - Not Applicable

#### 1.4.6 COMPLIANCE DATA CONTACT

This column identifies the person or organization responsible for supplying the necessary data that verifies the requirement and shows compliance.

#### 1.4.7 COMPLIANCE DATA

This column references the verification activities (i.e., procedures) and supporting documentation (i.e., reports) necessary to verify the requirement and show compliance.

EXHIBIT

#### 1.4.8 NON-CONFORMANCES

This column notes the Discrepancy Report (DR), Software Discrepancy Report (SDR) or Non-Conformance Report (NCR) in the case where verification is not achieved. When the verification process is complete, the report will be finalized and the discrepancy closeout or waiver noted.

#### 1.4.9 COMMENTS/REMARKS

This column is used to provide additional information which may support compliance to the requirement.

**EXAMPLE**



**EXAMPLE**  
SECTION II  
VERIFICATION COMPLIANCE MATRIX

**VERIFICATION REQUIREMENTS COMPLIANCE**

SRD/IRD REQ	CEI REQ	VRSD REQ	REQUIREMENT STATEMENT	COMP. METH.	COMPLIANCE DATA	NON-CONF.	COMMENTS/REMARKS
S3.0	3		<b>REQUIREMENTS</b>	R,I	A) Memo EB34 (94-07), SEDS-2 Electronics Box Hardware Review, M. Teal to F. Smith, 2/1/94		CLOSED
			Experiment designers shall assure that all SEDS-2 hardware meets the Range Safety requirements found in ESMCR 127-1 and referenced military standards.		B) Air Force Memo, From 45SPW/SESM To Tom Rucci, 1/10/94		
					C) MSPSP		
S3.1			<b>Mission Requirements</b>				CLOSED
			The SEDS-2 shall be designed to accomplish the following mission requirements: a. Deploy an endmass attached to a tether, b. Apply braking action which shall control the tether during deployment and damp vibrations about the local vertical,				
			c. Provide the capability to cut the tether after endmass-deployment, and d. Transmit data for post-flight analysis				
	3.1		<b>Mission Requirements</b>	A,T,I	A) See REF SRD REQs Below		CLOSED
			The DS shall be designed to meet the mission requirements of MSFC-DOC-2233.				
			REF SRD REQ 3.1A	A	A) ED13-36-93, SEDS-2 Verification Requirements Compliance Document from J. Powers to F. Smith, 11/15/93		CLOSED
			REF SRD REQ 3.1B	A	A) ED13-36-93, SEDS-2 Verification Requirements Compliance Document from J. Powers to F. Smith, 11/15/93		CLOSED
			REF SRD REQ 3.1C	T,I	A) Letter from Joe Carroll, Tether Applications, to J. Harrison, Cutter Qualification Tests, 1/21/93		CLOSED

2.4 - 16

**VERIFICATION REQUIREMENTS COMPLIANCE**

SRD/IRD REQ	CEI REQ	VRSD REQ	REQUIREMENT STATEMENT	COMP. METH.	COMPLIANCE DATA	NON-CONF.	COMMENTS/REMARKS
					B) Memo CQ06 (94-4), SEDS-2 Configuration Verification AA04, From H. Smith to F. Smith, 2/2/94		
			REF SRD REQ 3.1D	T	A) KTCP-FS-SEDS-510B, SEDS-2 DMCO Test Procedure, 12/21/93		CLOSED
S3.2	3.2		<b>Experiment Requirements</b>	N/A			CLOSED
S3.2.1			<b>Deployer System Requirements</b>				CLOSED
	3.2.1		<b>Deployer System Requirements</b> The DS shall be comprised of an Electronics Box which houses the Communications & Data Management System (C&DM), the Deployer (consisting of the Deployer Canister, Baseplate, and Core), the Tether, Brake/Cutter Assembly and cables.	N/A			CLOSED
I6.0			<b>SEDS-2/Delta II Electrical Interfaces</b> The SEDS-2 deployer shall require electrical interfaces between it and the Delta II launch vehicle.				CLOSED
			There shall be no electrical interface between the SEDS-2 endmass and the Delta II. No SEDS-2 specific ground electrical interfaces shall be required with the blockhouse.				
			Firing of the endmass clampband assembly shall be handled completely by the launch vehicle. At clampband release, the endmass transmitter shall be turned on by the separation switches on the endmass.				
			The SEDS-2 deployer electrical interface with the launch vehicle shall consist of a power and a data interface.				

**UNCLASSIFIED**

**VERIFICATION REQUIREMENTS COMPLIANCE**

SRD/IRD REQ	CEI REQ	VRSD REQ	REQUIREMENT STATEMENT	COMP. METH.	COMPLIANCE DATA	NON- CONF.	COMMENTS/ REMARKS
			The experiment shall be initiated by a sequence of commands from the Delta II second stage on-board guidance computer (GC).				
			These commands shall be sent to a secondary payload relay box (SPRB) on the Delta II second stage designed specifically for the SEDS-2 mission.				
			The GC sequences the SPRB, activating relays that provide power to the SEDS-2 electronics box, switches a Delta II telemetry channel over to the deployer telemetry signal, fires the pyrotechnic initiators for endmass deployment, provides a sense signal				
			indicating endmass separation command, and issues signals to the tether cutter pyrotechnic devices.				
			The primary tether cutter command is sent by the SEDS-2 electronics box to the SPRB to initiate the tether cutter pyrotechnic devices.				
			The backup tether cutter command is sent by the Delta II GC.				
<b>I6.3</b>			<b>SEDS-2/Delta II Power Interface</b>				<b>CLOSED</b>
			The SEDS-2 shall be supplied power from a special battery on the Delta II launch vehicle.				
			The deployer system shall operate at 28 +/- 4 volts.				
			The maximum current is .18 amps when the brake motor is off and 1.2 amps when the brake motor is on.				
			The power peaks shall occur as a function of the deployment process so the time of the occurrence could vary ±10 percent.				

**UNCLASSIFIED**

2.4 - 18

**VERIFICATION REQUIREMENTS COMPLIANCE**

<b>SRD/IRD REQ</b>	<b>CEI REQ</b>	<b>VRSD REQ</b>	<b>REQUIREMENT STATEMENT</b>	<b>COMP. METH.</b>	<b>COMPLIANCE DATA</b>	<b>NON-CONF.</b>	<b>COMMENTS/REMARKS</b>
			A second battery shall be supplied by the Delta II to provide power for firing of the endmass clampband pyrotechnics.				
			The data system power bus protection and pyrotechnic initiator interface are shown in Figure 6.3-2.				
S3.2.1g			Receive power from the Delta II				CLOSED
	3.2.1.1		<b>Electronics Box</b>	N/A			CLOSED
	3.2.1.1a		The DS C&DM system shall operate at 28 +/- 4 volts. The maximum current is .18 amps when the brake motor is off and 1.2 amps when the brake motor is on.	R,A,T	A) Memo EB34 (94-07), SEDS-2 Electronics Box Hardware Review, M. Teal to F. Smith, 2/1/94 B) MTCP-FS-SEDS-504A Procedure Unit 1 C) SEDS/QUAL/EL94-001 Unit #1 Qualification Test Report D) MTCP-FS-SEDS-504A Procedure Unit 3 E) SEDS/QUAL/EL94-002 Unit #3 Qualification Test Report		CLOSED
I6.4.1			<b>Telemetry</b> The SEDS-2 deployer shall use one channel of the Delta II second stage telemetry system. The telemetry driver is shown in Figure 6.4.1. Output signal level: zero = 1.0 ±0.5V one = 4.0 ±0.5V. Modulation is PCM at 4,800 bits per second				CLOSED
I6.4.2			<b>Sense In</b>				CLOSED

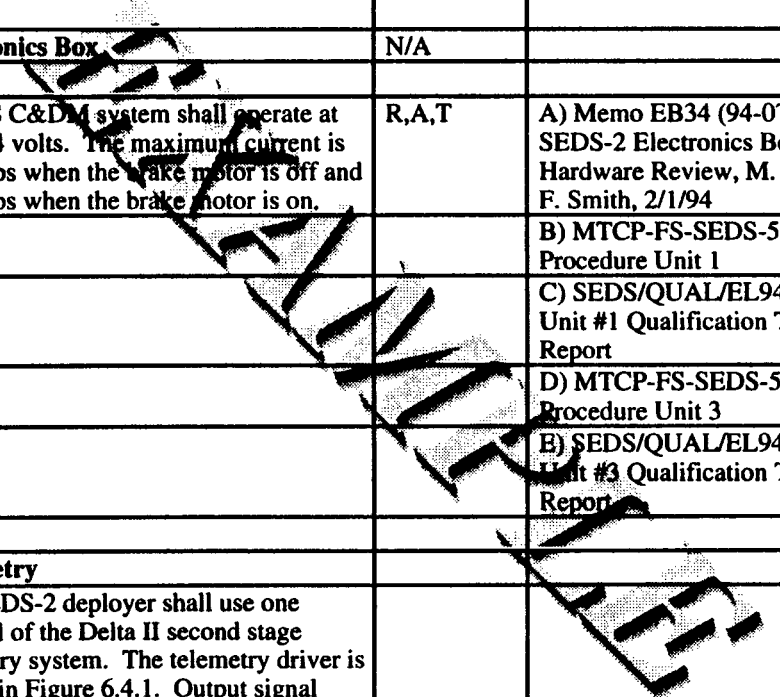

**VERIFICATION REQUIREMENTS COMPLIANCE**

SRD/IRD REQ	CEI REQ	VRSD REQ	REQUIREMENT STATEMENT	COMP. METH.	COMPLIANCE DATA	NON-CONF.	COMMENTS/REMARKS
			The sense in interface is shown in Figure 6.4.1. Off state less than or equal to 0.5 VDC ; On state 2.5-4.0 VDC ; Load = 10K Ohms				
I4.3			<b>Deployer System Data Signal Characteristics and Format</b>				CLOSED
			The SEDS-2 deployer system shall use one channel of the Delta II second stage telemetry system.				
			The frequency is 2241.5 MHz.				
			The signal characteristics shall be FM/FM modulation at 4800 bits per second with the serial data stream UART-compatible, 8 data bits, one stop bit and one start bit per word.				
			A deviation of 15% shall be used with a subcarrier frequency of 40 kHz.				
			Maximum signal levels correspond to $\pm 1.5$ volt.				
			The bit stream shall be a continuous and repeated dump of the entire computer mass memory.				
			As new data is acquired by the on-board computer, the data shall be stored after the last previous measurement.				
			The 4800 bps data rate for the deployer system channel shall require 6 minutes to dump the 115 kilobytes of deployer system on-board computer memory through the Delta telemetry link.				
S3.2.1d			Record data for continuous retransmission of the entire memory contents				CLOSED
S3.2.1e			Utilize one channel of the Delta II downlink				CLOSED

**UNCLASSIFIED**

2.4 - 20

**VERIFICATION REQUIREMENTS COMPLIANCE**

<b>SRD/IRD REQ</b>	<b>CEI REQ</b>	<b>VRSD REQ</b>	<b>REQUIREMENT STATEMENT</b>	<b>COMP. METH.</b>	<b>COMPLIANCE DATA</b>	<b>NON-CONF.</b>	<b>COMMENTS/REMARKS</b>
	3.2.1.1b		The DS C&DM system shall provide a minimum of 115 kilobytes of data storage and shall record all generated DS parameters.	R,T	A) Memo EB34 (94-07), SEDS-2 Electronics Box Hardware Review, M. Teal to F. Smith, 2/1/94		CLOSED
			The DS C&DM shall interface with the Delta II to transmit telemetry to the ground at a data rate of 4800 ± 10 bits per second.		B) See VRSD Tests 3.4, 3.6 & 3.7 Below		W-92-977A, A3 Drill & Trim Boards
					(C) SEDS-2 Software Verification Test Report (DM23)		W-92-976A, A1 Drill & Trim Boards
					D) Software CDR August 31, 1993		W-92-938C, A2 Circuit Card Jumper Wire
		3.4	<b>DMCO Test</b>	T	A) KTCP-FS-SEDS-510B, SEDS-2 DMCO Test Procedure, 12/21/93		CLOSED
			Verify SEDS-2 sensor operation through Delta telemetry: A. Tensiometer, B. Turns Counter, C. Temperature				
		3.6	<b>F12 Test</b>		A) KTCP-QS-SEDS-511 SEDS-2 F12 Test Procedure, Performed 2/25/94		CLOSED
			Verify SEDS-2 sensor operation through Delta telemetry: A. Tensiometer, B. Turns Counter, C. Temperature				
		3.7	<b>F6 Test</b>	T	A) KTCP-QS-SEDS-512 SEDS-2 F6 Test Procedure, Performed 3/2/94		CLOSED
			Verify SEDS-2 sensor operation through Delta telemetry: A. Tensiometer, B. Turns Counter, C. Temperature				
S3.2.1i			Monitor endmass deployment signals from the Delta II				

**FINAL**

**VERIFICATION REQUIREMENTS COMPLIANCE**

SRD/IRD REQ	CEI REQ	VRSD REQ	REQUIREMENT STATEMENT	COMP. METH.	COMPLIANCE DATA	NON-CONF.	COMMENTS/REMARKS
S3.2.1f			Receive discretes from the Delta II sequencer				
	3.2.1.1c		The DS C&DM system shall be designed to receive commands from the Delta II including a start-up signal.	R,T	A) Memo EB34 (94-07), SEDS-2 Electronics Box Hardware Review, M. Teal to F. Smith, 2/1/94 B) See VRSD Tests 3.4, 3.6 & 3.7 Below		CLOSED
		3.4	<b>DMCO Test</b> Verify SEDS-2 power-up signal from Delta Verify "sense" signal indicating endmass separation command	T	A) KTCP-FS-SEDS-510B, SEDS-2 DMCO Test Procedure, 12/21/93		CLOSED
		3.6	<b>F12 Test</b> Verify SEDS-2 power-up signal from Delta Verify "sense" signal indicating endmass separation command	T	A) KTCP-QS-SEDS-511 SEDS-2 F12 Test Procedure, Performed 2/25/94		CLOSED
		3.7	<b>F6 Test</b> Verify SEDS-2 power-up signal from Delta Verify "sense" signal indicating endmass separation command	T	A) KTCP-QS-SEDS-512 SEDS-2 F6 Test Procedure, Performed 3/2/94		CLOSED
S3.2.1j			Activate a stepper motor which increases and decreases the drag on the tether as a closed loop function of the turns count				CLOSED



**VERIFICATION REQUIREMENTS COMPLIANCE**

SRD/IRD REQ	CEI REQ	VRSD REQ	REQUIREMENT STATEMENT	COMP. METH.	COMPLIANCE DATA	NON-CONF.	COMMENTS/REMARKS
	3.2.1.1e		The DS C&DM system shall control the tether brake mechanism.	R,T	A) Memo EB34 (94-07), SEDS-2 Electronics Box Hardware Review, M. Teal to F. Smith, 2/1/94		CLOSED
			The DS C&DM data system shall activate a stepper motor which increases and decreases the drag on the tether, by rotating the brake shaft thereby wrapping the tether, as a closed loop function of the turns count.		B) See VRSD Test 3.3 Below		
		3.3	Deployment Test	T	A) MTCP-QS-SEDS-508A Procedure Unit 1		CLOSED
			Verify Brake Motor Operation		B) SEDS/QUAL/EL94-001 Unit #1 Qualification Test Report	TDR MTCP-QS-SEDS-508A-001 UNIT 1	Incorrect GSE Software
					C) PTR1-DEPLOY, Post Test Review, Unit #1, Deployment Test		High Tether Tension Unit 1 Non-Flight Hardware
					D) MTCP-QS-SEDS-508A Procedure Unit 3		
					E) SEDS/QUAL/EL94-002 Unit #3 Qualification Test Report		
					F) PTR1-DEPLOY, Post Test Review, Unit #3, Deployment Test		
S3.2.1c			Measure the temperature of the deployer system				CLOSED
	3.2.1.1f		The DS C&DM system shall include a thermistor to monitor temperature of the electronics box.	R,T,I	A) Memo EB34 (94-07), SEDS-2 Electronics Box Hardware Review, M. Teal to F. Smith, 2/1/94		CLOSED

**VERIFICATION REQUIREMENTS COMPLIANCE**

SRD/IRD REQ	CEI REQ	VRSD REQ	REQUIREMENT STATEMENT	COMP. METH.	COMPLIANCE DATA	NON- CONF.	COMMENTS/ REMARKS
					B) See VRSD Tests 3.1 & 3.2 Below		Waiver W-94-1080, During Configuration Inspection of Electronics Box, Changed Box Dimensions
					C) Memo CQ06 (94-4), SEDS-2 Configuration Verification AA04, From H. Smith to F. Smith, 2/2/94		Waiver W-94-1079, During Configuration Inspection of Electronics Box, Change On Drill and Trim Boards
		3.1	<b>Pre/Post Environmental</b>	T	A) MTCP-FS-SEDS-504A Procedure Unit 1		CLOSED
			Verify Temperature Sensors Operation		B) SEDS/QUAL/EL94-001 Unit #1 Qualification Test Report		
					C) MTCP-FS-SEDS-504A Procedure Unit 3		
					D) SEDS/QUAL/EL94-002 Unit #3 Qualification Test Report		
		3.2	<b>Thermal Vacuum Functional</b>	T	A) MTCP-QS-SEDS-509A Procedure Unit 1		CLOSED
			Verify Temperature Sensors Operation		B) SEDS/QUAL/EL94-001 Unit #1 Qualification Test Report		
					C) PTR1-TV, Post Test Review, Unit 1, Thermal Vacuum		
					D) MTCP-QS-SEDS-509A Procedure Unit 3		
					E) SEDS/QUAL/EL94-002 Unit #3 Qualification Test Report		

**EXAMINER**

**VERIFICATION REQUIREMENTS COMPLIANCE**

SRD/IRD REQ	CEI REQ	VRSD REQ	REQUIREMENT STATEMENT	COMP. METH.	COMPLIANCE DATA	NON-CONF.	COMMENTS/REMARKS
					F) PTR3-TV, Post Test Review, Unit 3, Thermal Vacuum		
S3.2.1d			Record data for continuous retransmission of the entire memory contents				CLOSED
	3.2.1.1g		The DS shall store the data onboard for the entire flight, except the data which is sampled at time intervals in which case the data will be overwritten after 6000 seconds.	R,T	A) Memo EB34 (94-07), SEDS-2 Electronics Box Hardware Review, M. Teal to F. Smith, 2/1/94		CLOSED
			The data system shall continuously and repetitively transmit the stored data through the Delta telemetry system		B) See VRSD Tests 3.4, 3.6 & 3.7 Below		
		3.4	<b>DMCO Test</b>	T	A) KTCP-FS-SEDS-510B, SEDS-2 DMCO Test Procedure, 12/21/93		CLOSED
			Verify SEDS-2 sensor operation through Delta telemetry: A. Tensiometer, B. Turns Counter, C. Temperature				
		3.6	<b>F12 Test</b>	T	A) KTCP-QS-SEDS-511 SEDS-2 F12 Test Procedure, Performed 2/25/94		CLOSED
			Verify SEDS-2 sensor operation through Delta telemetry: A. Tensiometer, B. Turns Counter, C. Temperature				
		3.7	<b>F6 Test</b>	T	A) KTCP-QS-SEDS-512 SEDS-2 F6 Test Procedure, Performed 3/2/94		CLOSED
			Verify SEDS-2 sensor operation through Delta telemetry: A. Tensiometer, B. Turns Counter, C. Temperature				

2.4 - 25

**VERIFICATION REQUIREMENTS COMPLIANCE**

SRD/IRD REQ	CEI REQ	VRSD REQ	REQUIREMENT STATEMENT	COMP. METH.	COMPLIANCE DATA	NON-CONF.	COMMENTS/REMARKS
S3.2.1a			Measure the required data to determine tether deployment payout length and speed as a function of time				CLOSED
	3.2.1.2		Deployer	N/A			CLOSED
	3.2.1.2a		The Deployer canister and baseplate shall house the tether.	I	A) Memo CQ06 (94-4), SEDS-2 Configuration Verification AA04, From H. Smith to F. Smith, 2/2/94		CLOSED
	3.2.1.2b		The Deployer canister shall be instrumented with two pair of infrared emitters and detectors to count the turns the tether makes as it deploys off the end of the tether core.	T,I	A) Memo CQ06 (94-4), SEDS-2 Configuration Verification AA04, From H. Smith to F. Smith, 2/2/94		CLOSED
			A third infrared emitter and detector called the brake enable switch, is used only as an indication of tether length at the time it is triggered.		B) See VRSD Tests 3.1 & 3.3 Below		Waiver W-94-1082, During Configuration Inspection of Deloyer Assembly, Changed Locknut to Plain Nut
							Waiver W-92-992A, Canister Sensor Mount Welds
		3.1	<b>Pre/Post Environmental</b>	T	A) MTCP-FS SEDS-504A Procedure Unit 1		CLOSED
			Verify Turn Counter Operation		B) SEDS/QUAL/TBD Unit #1 Qualification Test Report		
					C) MTCP-FS-SEDS-504A Procedure Unit 3		
					D) SEDS/QUAL/TBD Unit #3 Qualification Test Report	DR 6344 UNIT 3	Discrepant Phototransistor

2.4 - 26

**VERIFICATION REQUIREMENTS COMPLIANCE**

SRD/IRD REQ	CEI REQ	VRSD REQ	REQUIREMENT STATEMENT	COMP. METH.	COMPLIANCE DATA	NON-CONF.	COMMENTS/REMARKS
		3.3	Deployment Test	T	A) MTCP-QS-SEDS-508A Procedure Unit 1		CLOSED
			Verify Tether Turn Counter Operation		B) SEDS/QUAL/EL94-001 Unit #1 Qualification Test Report	TDR MTCP- QS- SEDS- 508A- 001 UNIT 1	Incorrect GSE Software
					C) PTR1-DEPLOY, Post Test Review, Unit #1, Deployment Test		High Tether Tension Unit 1 Non-Flight Hardware
					D) MTCP-QS-SEDS-508A Procedure Unit 3		
					E) SEDS/QUAL/EL94-002 Unit #3 Qualification Test Report		
					F) PTR3-DEPLOY, Post Test Review, Unit #3, Deployment Test		
S3.2.1c			Measure the temperature of the deployer system				CLOSED
	3.2.1.2c		Two thermistors shall be provided, one in the tether core and one at the top of the cannister, to monitor the temperature.	T,I	A) Memo CQ06 (94-4), SEDS- Configuration Verification AA04, From H. Smith to F. Smith, 2/2/94 B) See VRSD Tests 3.1 & 3.2 Below		CLOSED
		3.1	Pre/Post Environmental	T	A) MTCP-FS-SEDS-504A Procedure Unit 1		CLOSED
			Verify Temperature Sensors Operation		B) SEDS/QUAL/EL94-001 Unit #1 Qualification Test Report		
					C) MTCP-FS-SEDS-504A Procedure Unit 3	DR 6348 UNIT 3	Discrepant Thermistor

**EXPIRED**

2.4 - 27

**VERIFICATION REQUIREMENTS COMPLIANCE**

SRD/IRD REQ	CEI REQ	VRSD REQ	REQUIREMENT STATEMENT	COMP. METH.	COMPLIANCE DATA	NON-CONF.	COMMENTS/REMARKS
					D) SEDS/QUAL/EL94-002 Unit #3 Qualification Test Report		
		3.2	<b>Thermal Vacuum Functional</b>	T	A) MTCP-QS-SEDS-509A Procedure Unit 1		CLOSED
			Verify Temperature Sensors Operation		B) SEDS/QUAL/EL94-001 Unit #1 Qualification Test Report		
					C) PTR1-TV, Post Test Review, Unit 1, Thermal Vacuum		
					D) MTCP-QS-SEDS-509A Procedure Unit 3		
					E) SEDS/QUAL/EL94-002 Unit #3 Qualification Test Report		
					F) PTR3-TV, Post Test Review, Unit 3, Thermal Vacuum		
	3.2.1.2d		All deployer hardware that could come in contact with the tether during the endmass deployment sequence shall be designed so as not to interfere with or snag the tether.	A)	A) PS04, Hot and Cold Deployment Data Analysis, 2/1/93		CLOSED
					B) Final Report on NASA SBIR-Phase II by Joe Carroll and Charles Alexander, 12/87		
					C) Star Carroll's FRR Dynamic Assessment Presentation, 2/9/93		
	3.2.1.3		<b>Tether</b>	N/A			CLOSED
	3.2.1.3a		The tether material shall be Spectra 1000 with pre-deployment exposed tether being Kevlar for thermal and mechanical protection.	I	A) Memo CQ06 (94-4), SEDS-2 Configuration Verification AA04, From H. Smith to F. Smith, 2/2/94		CLOSED

2.4 - 28

**VERIFICATION REQUIREMENTS COMPLIANCE**

SRD/IRD REQ	CEI REQ	VRSD REQ	REQUIREMENT STATEMENT	COMP. METH.	COMPLIANCE DATA	NON-CONF.	COMMENTS/REMARKS
I4.1.6			<b>Endmass/Deployer Interface</b>				CLOSED
			The only physical interface between the endmass and the SEDS-2 deployer hardware shall be the tether connection. Figure 4.1.1 shows the tether attached to the endmass load cell.				
			The tether shall be connected to the load cell by LaRC with assistance from Tether Applications, if required.				
			This connection shall take place as late in the processing flow as possible.				
	3.2.1.3b		The tether shall be 20 km ± 100 m in length, in addition to the first 2.54 cm which are exposed to the third stage plume environment outside the canister covered in heat resistant shrink wrap.	I	A) Memo CQ06 (94-4), SEDS-2 Configuration Verification AA04, From H. Smith to F. Smith, 2/2/94		CLOSED
			The end of the tether that interfaces with the Endmass shall incorporate a tie point.				
	3.2.1.3c		The tether shall be wound on a core per SEDS-PROC-01.		A) Memo CQ06 (94-4), SEDS-2 Configuration Verification AA04, From H. Smith to F. Smith, 2/2/94		CLOSED
	3.2.1.4		<b>Brake/Cutter Assembly</b>	N/A			CLOSED
	3.2.1.4a		The brake/cutter assembly shall utilize a stepper motor to drive the braking mechanism.	T,I	A) Memo CQ06 (94-4), SEDS-2 Configuration Verification AA04, From H. Smith to F. Smith, 2/2/94 B) See VRSD Test 3.3 Below		CLOSED
		3.3	<b>Deployment Test</b>	T	A) MTCP-QS-SEDS-508A Procedure Unit 1		CLOSED

**VERIFICATION REQUIREMENTS COMPLIANCE**

SRD/IRD REQ	CEI REQ	VRSD REQ	REQUIREMENT STATEMENT	COMP. METH.	COMPLIANCE DATA	NON- CONF.	COMMENTS/ REMARKS
			Verify Brake Motor Operation		B) SEDS/QUAL/EL94-001 Unit #1 Qualification Test Report	TDR MTCP- QS- SEDS- 508A- 001 UNIT 1	Incorrect GSE Software
					C) PTR1-DEPLOY, Post Test Review, Unit #1, Deployment Test		High Tether Tension Unit 1 Non-Flight Hardware
					D) MTCP-QS-SEDS-508A Procedure Unit 3		
					E) SEDS/QUAL/EL94-002 Unit #3 Qualification Test Report		
					F) PTR3-DEPLOY, Post Test Review, Unit #3, Deployment Test		
I4.1			<b>SEDS-2 Hardware Description</b>				CLOSED
			SEDS-2 is a "spinning reel" deployer designed to deploy a 57 +/- 1 pound instrumented endmass downward toward Earth at the end of a 20 +/- .1 kilometer long tether. The major system components and their typical weights are given below in Table 5.3.				
			Figure 4.1-1 shows the relative position of the SEDS-2 experiment on the Delta II and Figure 4.1-2 shows the position on the second stage.				
			A clampband assembly will be used to attach the endmass to the Delta II. The assembly will be furnished by MDA. The clampband assembly utilizes two bolt cutter-pyrotechnic charges and four springs to eject the endmass.				
			The clampband bolt cutters will be furnished by MDA.				



**VERIFICATION REQUIREMENTS COMPLIANCE**

SRD/IRD REQ	CEI REQ	VRSD REQ	REQUIREMENT STATEMENT	COMP. METH.	COMPLIANCE DATA	NON-CONF.	COMMENTS/REMARKS
			The brake/cutter is designed to use two pyrotechnic initiators to cut the tether. The pyrotechnic initiators will be furnished by NASA/MSFC.				
			For SEDS-2, inert pyros will be used to allow the tether and endmass to remain attached to the DS on the Delta II.				
			Ground tracking of the SEDS-2 will be done by radar. The SEDS-2 endmass has an integral radar reflector on its upper surface to aid in tracking it to determine its position relative to the Delta II second stage.				
			The SEDS-2 endmass has been designed to burn-up entirely during re-entry to eliminate the possibility of impact. The endmass baseplate design has cutouts exposing thin aluminum sheeting which will melt to allow heating of the interior.				
I5.1.2			<b>Electronics Box/Brake Cutter</b>				CLOSED
			The electronics box shall be bolted to the MDA support longerons (1D71104) using four (NAS1351N3) bolts provided by MDA. The torque shall be 20-25 in-lbs. Figure 5.1.1-1 shows the MDA interface for the electronics box.				
			The electronics box interface hole pattern is shown in Figure 5.1.2.				
			The inert pyrotechnic NSI charges and connectors for the tether cutter shall be installed before the deployer is mated to the second stage. MSFC shall be responsible for the installation of the MSFC-supplied tether cutter pyrotechnic NSI's.				
			The inert pyrotechnic NSI's will be electrically connected after mating.				
S3.2.1h			Provide the capability for tether cutting				CLOSED

2.4 - 31

**VERIFICATION REQUIREMENTS COMPLIANCE**

SRD/IRD REQ	CEI REQ	VRSD REQ	REQUIREMENT STATEMENT	COMP. METH.	COMPLIANCE DATA	NON-CONF.	COMMENTS/REMARKS
	3.2.1.4b		The brake/cutter assembly shall utilize redundant pyrotechnic activation devices (NASA Standard Initiators (NSI) SEB26100001-250) to provide the capability to cut the tether.	T,I	A) Letter from Joe Carroll, Tether Applications, to J. Harrison, Cutter Qualification Tests 1/21/93 B) Memo CQ06 (94-4), SEDS-2 Configuration Verification AA04, From H. Smith to F. Smith, 2/2/94 C) Inert Pyrotechnic Firing Procedure, FED-ORD-177 D) Inert Pyrotechnic Installation Procedure, FED-ORD-178, Performed 2/28/94		CLOSED
	3.2.1.1d		The DS C&DM system shall not be required to initiate a tether cutter command to the Delta II.	N/A			CLOSED
S3.2.1c			Measure the temperature of the deployment system				CLOSED
	3.2.1.4c		The brake/cutter assembly shall include a thermistor to monitor temperature of the brake/cutter assembly.	T,I	A) Memo CQ06 (94-4), SEDS-2 Configuration Verification AA04, From H. Smith to F. Smith, 2/2/94 B) See VRSD Tests 3.1 & 3.2 Below		CLOSED
		3.1	<b>Pre/Post Environmental</b>	T	A) MTCF-FS-SEDS-504A Procedure Unit 1		CLOSED
			Verify Temperature Sensors Operation		B) SEDS/QUAL/EL94-001 Unit #1 Qualification Test Report C) MTCF-FS-SEDS-504A Procedure Unit 3 C) SEDS/QUAL/EL94-002 Unit #3 Qualification Test Report		

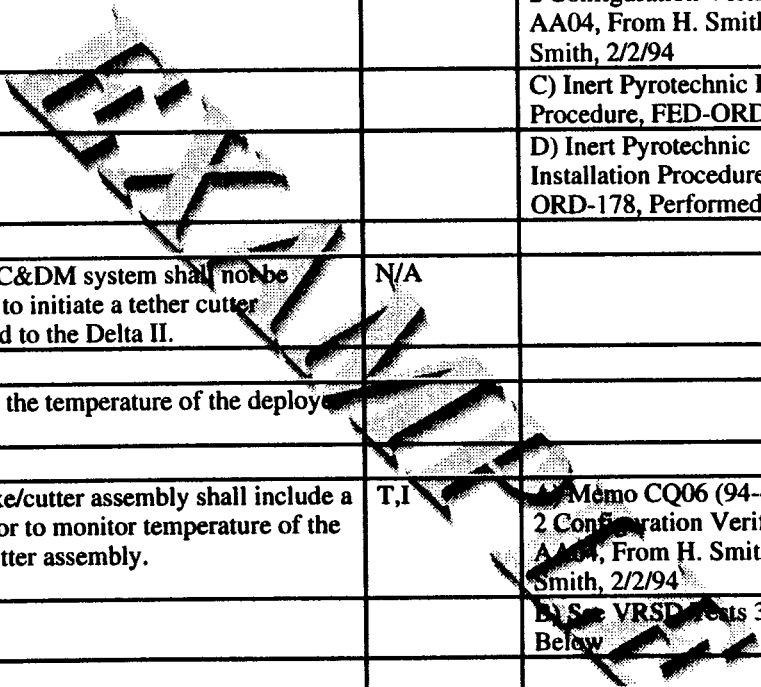

2.4 - 32

**VERIFICATION REQUIREMENTS COMPLIANCE**

SRD/IRD REQ	CEI REQ	VRSD REQ	REQUIREMENT STATEMENT	COMP. METH.	COMPLIANCE DATA	NON-CONF.	COMMENTS/REMARKS
		3.2	<b>Thermal Vacuum Functional</b>	T	A) MTCP-QS-SEDS-509A Procedure Unit 1		CLOSED
			Verify Temperature Sensors Operation		B) SEDS/QUAL/EL94-001 Unit #1 Qualification Test Report		
					C) PTR1-TV, Post Test Review, Unit 1, Thermal Vacuum		
					D) MTCP-QS-SEDS-509A Procedure Unit 3		
					E) SEDS/QUAL/EL94-002 Unit #3 Qualification Test Report		
					F) PTR3-TV, Post Test Review, Unit 3, Thermal Vacuum		
S3.2.1b			Measure the tether tension				CLOSED
	3.2.1.4d		The brake/cutter assembly shall utilize running line tensiometer to measure tether tension	T,1	A) Memo CQ06 (94-4), SEDS-2 Configuration Verification AA04, From H. Smith to F. Smith 2/2/94		CLOSED
					B) See VRSD Tests 3.1 & 3.3 Below		Waiver W-94-1081, During Configuration Inspection of Brake Assembly & LVDT, Changed Length of Cable Wires
		3.1	<b>Pre/Post Environmental</b>	T	A) MTCP-FS-SEDS-504A Procedure Unit 1		CLOSED
			Verify Tether Tension Measurement		B) SEDS/QUAL/EL94-001 Unit #1 Qualification Test Report		
					C) MTCP-FS-SEDS-504A Procedure Unit 3		

**RETRACTED**

2.4 - 33

**VERIFICATION REQUIREMENTS COMPLIANCE**

SRD/IRD REQ	CEI REQ	VRSD REQ	REQUIREMENT STATEMENT	COMP. METH.	COMPLIANCE DATA	NON-CONF.	COMMENTS/REMARKS
					C) SEDS/QUAL/EL94-002 Unit #3 Qualification Test Report		
		3.3	<b>Deployment Test</b>	T	A) MTCP-QS-SEDS-508A Procedure Unit 1		CLOSED
			Verify Tether Tension Measurement		B) SEDS/QUAL/EL94-001 Unit #1 Qualification Test Report	TDR MTCP- QS- SEDS- 508A- 001 UNIT 1	Incorrect GSE Software
					C) PTR1-DEPLOY, Post Test Review, Unit #1, Deployment Test		High Tether Tension Unit 1 Non-Flight Hardware
					D) MTCP-QS-SEDS-508A Procedure Unit 3		
					E) SEDS/QUAL/EL94-002 Unit #3 Qualification Test Report		
					F) PTR3-DEPLOY, Post Test Review, Unit #3, Deployment Test		
S3.3	3.3		<b>Operational Requirements</b>	N/A			CLOSED
S3.3.1			<b>Flight Operations Requirements</b>				CLOSED
			All SEDS-2 operations shall be performed after the third stage separation.				
			The SEDS-2 requires the post depletion burn orbital and attitude elements of the Delta II second stage as defined in the MDA Mission Specification and the SEDS-2/Delta II Interface Specification (MSFC-SPEC-2235).				
	3.3		<b>Flight Operations Requirements</b>	N/A			CLOSED

**EXAMINER**

2.4 - 34

**VERIFICATION REQUIREMENTS COMPLIANCE**

SRD/IRD REQ	CEI REQ	VRSD REQ	REQUIREMENT STATEMENT	COMP. METH.	COMPLIANCE DATA	NON- CONF.	COMMENTS/ REMARKS
			The flight operations are as stated in MSFC-DOC-2233.				
S3.3.2			<b>Ground Operations Requirements</b>				CLOSED
S3.3.2.1			<b>Ground Processing/Integration</b>				CLOSED
			The SEDS-2 requirements for ground operations and activities for the SEDS-2 prelaunch processing at the Kennedy Space Center (KSC) Payload Processing Facility (PPF) and subsequent integration into the McDonnell Douglas Aerospace (MDA) Delta II 725 launch				
			vehicle at the Cape Canaveral Air Force Station (CCAFS) Launch Complex 17 are defined in the Small Expendable Tether Deployer System Second Mission Launch Site Test Plan, MSFC-PLAN-2267.				
S3.3.2.2			<b>Radar Tracking</b>				CLOSED
			Ground radar stations will provide maximum coverage during the SEDS-2 experiment.				
			The value of measurements is such that those required stations which are available observe the experiment operation and record time, elevation, azimuth, range, range rate,				
			range acceleration, and Space Object Identification data (size, shape, and motion).				
			The ground radar tracking requirements are defined in the SEDS Program Requirements Document (PRD).				
	3.3.2		<b>Ground Operations Requirements</b>	N/A			CLOSED
			The ground operations are as stated in MSFC-DOC-2233.				

**UNCLASSIFIED**

2.4 - 35

**VERIFICATION REQUIREMENTS COMPLIANCE**

SRD/IRD REQ	CEI REQ	VRSD REQ	REQUIREMENT STATEMENT	COMP. METH.	COMPLIANCE DATA	NON-CONF.	COMMENTS/REMARKS
S3.4	3.4		<b>Mechanical Performance Requirements</b>	N/A			CLOSED
			The DS shall be designed to withstand the design launch and operational environments defined in this specification without failures.				
I5.9.5			<b>Factors of Safety</b>				CLOSED
			All MSFC provided hardware is designed to the factors of safety in MSFC-HDBK-505A and GSEP memo 100/93-220.				
S3.4.1	3.4.1		<b>Factors of Safety</b>	A	A) See VRSD Analysis 4.1 Below		CLOSED
			The SEDS-2 DS hardware shall be designed to the factors of safety in MSFC-HDBK-505 and MDC 93H0141.				
			Under limit loads, the structure shall not experience structural deformations that would limit performance of any on-orbit functions.				
			The DS shall be designed to withstand the loads identified in paragraph 3.14 of this document.				
		4.1	<b>Structural Analysis</b>	A	A) Memo ED24-94-01, SEDS-2 Margins of Safety, L. Barker to F. Smith, 12/94		CLOSED
			Verify SEDS hardware to withstand load factors at the required factors of safety				
I5.10.2			<b>Loads</b>				CLOSED
			The loads determined for SEDS-1 will be used for SEDS-2.				
S3.4.2	3.4.2		<b>Natural Frequency</b>	A,S	A) Analysis letter ED23-92-11, dated Mar 17, 1992 and letter from J. Harrison FA34, dated Mar 19,1992		CLOSED

**VERIFICATION REQUIREMENTS COMPLIANCE**

SRD/IRD REQ	CEI REQ	VRSD REQ	REQUIREMENT STATEMENT	COMP. METH.	COMPLIANCE DATA	NON-CONF.	COMMENTS/REMARKS
			To avoid dynamic coupling between low frequency vehicle and spacecraft modes, the stiffness of the DS assembly shall be designed to produce fundamental frequencies above 35 Hz. in the thrust axis and 15 Hz in the lateral axis		B) Test-SEDS-DEV-ED91-057 and letter ED73 (01-92), dated January 3, 1992		
			for spacecraft hardmounted at the spacecraft separation plane				
		4.4	<b>Dynamic Analysis</b>	A	A) Analysis letter ED23-92-11, dated Mar 17, 1992 and letter from J. Harrison FA34, dated Mar 19, 1992		CLOSED
			Verify SEDS hardware fundamental frequencies				
S3.5	3.5		<b>Electrical Requirements</b>	N/A			CLOSED
S3.5.1	3.5.1		<b>Electrical Power and Distribution System</b>	N/A			CLOSED
S3.5.1.1			<b>Deployer System</b>				CLOSED
			The Deployer System (DS) electronics box shall receive power from a Delta II launch vehicle battery.				
	3.5.1.1		<b>Deployer System</b>	T	A) See VRSD Test 3.7 Below		CLOSED
			The SEDS-2 DS shall meet the electrical requirements as stated in MSFC-DOC-2233.				
		3.7	<b>F6 Test</b>	T	A) KTCP-QS-SEDS-512 SEDS-2 F6 Test Procedure, Performed 3/2/94		CLOSED
			Verify SEDS-2 Power-up signal from Delta (Battery Switch-Over)				
I6.5			<b>Pyrotechnic Requirements</b>				CLOSED

2.4 - 37

**VERIFICATION REQUIREMENTS COMPLIANCE**

<b>SRD/IRD REQ</b>	<b>CEI REQ</b>	<b>VRSD REQ</b>	<b>REQUIREMENT STATEMENT</b>	<b>COMP. METH.</b>	<b>COMPLIANCE DATA</b>	<b>NON-CONF.</b>	<b>COMMENTS/REMARKS</b>
			Two circuits, minimum of 4 amps each for one second.				
S3.5.2	3.5.2		<b>Pyrotechnic/Ordnance Buses and Devices</b>	N/A			CLOSED
S3.5.2.1	3.5.2.1		<b>Deployer System</b>	N/A			CLOSED
			The MDA design of the electrical power buses that feed pyrotechnic loads shall provide the control noise decoupling, and transient regulation necessary to protect pyrotechnic devices from inadvertent firing.				
			NASA Standard Initiators SEB26100001-250 (NSI) shall be used.				
S3.5.3	3.5.3		<b>Cabling</b>	R,I	A) EB12 Memo, Verification Requirements Document EL45-CMPL-SEDS-2 from B. Green to F. Smith, 1/6/94		CLOSED
			All power cables shall be twisted pairs (unless wire size prohibits twisting) & command/monitoring signal lines shall be twisted pairs or twisted shielded pairs depending on interface requirements & wire sizes selected in accordance with load requirements		B) Memo CQ06 (94-4), SEDS-2 Configuration Verification AA04, From H. Smith to F. Smith, 2/2/94		
	3.5.3.1		<b>Shielding</b>	R,I	A) EB12 Memo, Verification Requirements Document EL45-CMPL-SEDS-2 from B. Green to F. Smith, 1/6/94		CLOSED
			All shields shall be routed through the associated connector on a separate designated pin and ground to the component case or to the backshell when the interface prohibits routing through the connector.		B) Memo CQ06 (94-4), SEDS-2 Configuration Verification AA04, From H. Smith to F. Smith, 2/2/94		



**VERIFICATION REQUIREMENTS COMPLIANCE**

SRD/IRD REQ	CEI REQ	VRSD REQ	REQUIREMENT STATEMENT	COMP. METH.	COMPLIANCE DATA	NON-CONF.	COMMENTS/REMARKS
	3.5.3.2		<b>Protective Covers and Caps</b>	R,I	A) Memo EB34 (94-07), SEDS-2 Electronics Box Hardware Review, M. Teal to F. Smith, 2/1/94		CLOSED
			All connectors shall be covered or protected, when not mated with another connector, with pink anti-static caps, to protect the electronics box circuitry and to insure removal before flight.		B) Memo CQ06 (94-4), SEDS-2 Configuration Verification AA04, From H. Smith to F. Smith, 2/2/94		
			The unused connectors shall be mated with a protective cover and may contain jumper wires to ground sensitive signals.				
S3.6	3.6		<b>Ground Support Equipment (GSE)</b>	N/A			CLOSED
S3.6.1	3.6.1		<b>General Requirements</b>	R,I	A) Memo EB34 (94-07), SEDS-2 Electronics Box Hardware Review, M. Teal to F. Smith, 2/1/94		CLOSED
			The design of the DS shall allow for human handling. Equipment required for launch site operations are defined in the SEDS-2 Launch Site Test Plan, MSFC-PLAN-2267.		B) Air Force Memo, From 45SPW/SESM To Tom Rucci, 1/10/94		
			All GSE shall meet the design requirements of the Payload Ground Safety Handbook (KHB 1700.7) as well as Range Safety Requirements (ESMCR 127-1).		C) MSPSP		
S3.6.1.1	3.6.1.1		<b>Mechanical</b>	I	A) Memo CQ06 (94-4), SEDS-2 Configuration Verification AA04, From H. Smith to F. Smith, 2/2/94		CLOSED
			There are no requirements for mechanical ground support equipment for the deployer system.				
			All hand tools that will be used on the launch pad shall be capable of being tethered.				

2.4 - 39

**VERIFICATION REQUIREMENTS COMPLIANCE**

SRD/IRD REQ	CEI REQ	VRSD REQ	REQUIREMENT STATEMENT	COMP. METH.	COMPLIANCE DATA	NON-CONF.	COMMENTS/REMARKS
S3.6.1.2	3.6.1.2		<b>Electrical</b> Electrical ground support equipment (EGSE) shall be required to verify the electrical performance of the DS.	N/A			CLOSED
S3.6.1.2	3.6.1.3		<b>Connectors</b> Electrical connectors shall be sized, clocked, or keyed so that it is physically impossible to mismatch connectors.	I	A) Memo CQ06 (94-4), SEDS-2 Configuration Verification AA04, From H. Smith to F. Smith, 2/2/94		CLOSED
S3.6.1.4	3.6.1.4		<b>Software</b> GSE Software is required to verify the DS electronics. The DS GSE software shall meet the requirements contained in MSFC-RQMT-TBD.	T,I	A) SEDS-2 Software Verification Test Report (DM23) B) Software CDR August 31, 1993		CLOSED
S3.7	3.7		<b>Airborne Support Equipment</b> The requirements for the ASE hardware shall be documented in MDC 93H0141. The following ASE shall be supplied: Two SEDS dedicated HR-1 batteries, SEDS dedicated electrical relay box, Support brackets for the SEDS Deployer Canister, Support longerons for the SEDS Electronics Box, Payload adapter fixture for the Endmass, Payload attach fitting, Clampband assembly, Separation switches, and SEDS hardware to MDA hardware attachment bolts.	N/A			CLOSED
I5.10.4			<b>Thermal</b>				CLOSED

2.4 - 40

**VERIFICATION REQUIREMENTS COMPLIANCE**

SRD/IRD REQ	CEI REQ	VRSD REQ	REQUIREMENT STATEMENT	COMP. METH.	COMPLIANCE DATA	NON-CONF.	COMMENTS/REMARKS
			A thermal analysis for lift-off/ascent, and the tether deployment period shall be conducted by MSFC with inputs required from TA. MDA will not provide mission specific thermal environment for SEDS-2.				
S3.8	3.8		<b>Thermal Protection System (TPS)</b>	A	ED63(58-93), SEDS-2 Pre-Deployment Thermal Analysis Results from S. Kittredge to F. Smith,		CLOSED
			A plume shield is required by SEDS-2 to enable the DS to meet the thermal requirements defined in paragraph 3.14.2.2.5.				
			The DS components shall not exceed the following temperature range (-10/+10°F) = Deployer Canister: -45 to 135°F				
			The DS components shall not exceed the following temperature range (-10/+10°F) = Electronics Box: -5 to 120°F				
			The DS components shall not exceed the following temperature range (-10/+10°F) = Printed Circuit Board: 21 to 84°F				
			The DS components shall not exceed the following temperature range (-10/+10°F) = Kevlar: -100 to 600°F				
			The DS components shall not exceed the following temperature range (-10/+10°F) = Spectra: -450 to 150°F				
			The DS components shall not exceed the following temperature range (-10/+10°F) = Brake/Cutter Ass.: -3 to 143°F				
		4.3	<b>Thermal Analysis</b>	A	ED63(58-93), SEDS-2 Pre-Deployment Thermal Analysis Results from S. Kittredge to F. Smith,		CLOSED
			Verify Electronics Box Temperature Does Not Exceed Limits				

2.4 - 41

**VERIFICATION REQUIREMENTS COMPLIANCE**

SRD/IRD REQ	CEI REQ	VRSD REQ	REQUIREMENT STATEMENT	COMP. METH.	COMPLIANCE DATA	NON-CONF.	COMMENTS/REMARKS
			Verify Tether (SPECTRA) Temperature Does Not Exceed Limits				
			Verify Tether (KEVLAR) Temperature Does Not Exceed Limits				
			Verify Brake/Cutter Assy Temperature Does Not Exceed Limits				
			Verify Deployer Canister Temperature Does Not Exceed Limits				
S3.9			<b>System Level Software Requirements</b> The detailed SEDS-2 DS flight software requirements shall be contained in MSFC-SPEC-2223.				CLOSED
			The SEDS-2 GSE software requirements shall be contained in MSFC-RQMT-2234.				
	3.9		<b>System Level Software Requirements</b>	N/A			CLOSED
	3.9.1		<b>Flight Software</b>	N/A			CLOSED
	3.9.1.1		<b>General</b>	N/A			CLOSED
					A) SEDS-2 Software Verification Test Report (DM23)		
					B) Software CDR August 31, 1993		
					C) See VRSD Test 3.3 Below		
			The SEDS-2 DS flight software shall perform the following: Count tether turns as the tether unwinds.				
			The SEDS-2 DS flight software shall perform the following: Log the time of each turn and other mission events.				
			The SEDS-2 DS flight software shall perform the following: Monitor tether tension.				

**VERIFICATION REQUIREMENTS COMPLIANCE**

SRD/IRD REQ	CEI REQ	VRSD REQ	REQUIREMENT STATEMENT	COMP. METH.	COMPLIANCE DATA	NON-CONF.	COMMENTS/REMARKS
			The SEDS-2 DS flight software shall perform the following: Record temperatures.				
			The SEDS-2 DS flight software shall perform the following: Control tether brake and cutter mechanisms.				
			The DS flight software shall meet the requirements contained in MSFC-RQMT-2065.				
		3.3	<b>Deployment Test</b>	T	A) MTCP-QS-SEDS-508A Procedure Unit 1		CLOSED
			Pre/Post Environmental Test		B) SEDS/QUAL/EL94-001 Unit #1 Qualification Test Report	TDR MTCP-QS-SEDS-508A-001 UNIT 1	Incorrect GSE Software
			Verify Deployment Speed To Approximate Flight Deployment Predictions		C) PTR1-DEPLOY, Post Test Review, Unit #1, Deployment Test		High Tether Tension Unit 1 Non-Flight Hardware
			Verify Tether Tension Measurement		D) MTCP-QS-SEDS-508A Procedure Unit 3		
			Verify Brake Motor Operation		E) SEDS/QUAL/EL94-002 Unit #3 Qualification Test Report		
			Verify Tether Turn Counter Operation		F) PTR3-DEPLOY, Post Test Review, Unit #3, Deployment Test		
	3.9.1.2		<b>Functional Requirements</b>	T,A	A) SEDS-2 Software Verification Test Report (DM23)		CLOSED
					B) Software CDR August 31, 1993		
			The SEDS-2 DS flight software shall be functionally divided into the Monitor module and the Mission module.				

2.4 - 43

**VERIFICATION REQUIREMENTS COMPLIANCE**

<b>SRD/IRD REQ</b>	<b>CEI REQ</b>	<b>VRSD REQ</b>	<b>REQUIREMENT STATEMENT</b>	<b>COMP. METH.</b>	<b>COMPLIANCE DATA</b>	<b>NON- CONF.</b>	<b>COMMENTS/ REMARKS</b>
			The Monitor module shall provide the following functional capabilities: a. the Power-On Initialization function, and b. the Command Processor function.				
			The Mission module shall provide the following functional capabilities: a. Mission Initialization, b. Mass RAM Initialization, c. Telemetry functions, d. Data acquisition, e. Data processing, f. Data storage, and g. Control functions.				
S3.10	3.10		<b>Physical Requirements</b>	N/A			CLOSED
I5.3			<b>Weight, Center of Gravity and Moment of Inertia for Each Component</b>				CLOSED
			Typical component information is shown in Table 5.3. Figures 5.3-1 and 5.3-2 indicate origin points, CG locations and dimensions of the SEDS-2 components.				
			Table 5.3 Weight, CG, & MOI (w/o cabling) - Deployer/Tether (Incl. Canister Cable) 21.39 pounds				
			Table 5.3 Weight, CG, & MOI (w/o cabling) - Electronics Box & Brake Cutter (Incl. Brake/Tensiometer Cable) 9.30 pounds				
			Table 5.3 Weight, CG, & MOI (w/o cabling) - Core Cable 0.48 pounds				
			Table 5.3 Center of Gravity, (CG Station-Inches) - Deployer/Tether (Incl. Canister Cable): X = 5.40, Y = 0.07 & Z = -0.06				
			Table 5.3 Center of Gravity, (CG Station-Inches) - Electronics Box & Brake Cutter (Incl. Brake/Tensionmeter Cable): X = 3.24, Y = 5.94 & Z = 2.27				
			Table 5.3 Center of Gravity, (CG Station-Inches) - Core Cable: X = 4.00, Y = 0.50 & Z = 0.00				

**VERIFICATION REQUIREMENTS COMPLIANCE**

<b>SRD/IRD REQ</b>	<b>CEI REQ</b>	<b>VRSD REQ</b>	<b>REQUIREMENT STATEMENT</b>	<b>COMP. METH.</b>	<b>COMPLIANCE DATA</b>	<b>NON- CONF.</b>	<b>COMMENTS/ REMARKS</b>
			Table 5.3 Moment of Inertia (Pound-Inches-Squared) - Deployer/Tether (Incl. Canister Cable): IX = 267, IY = 483 & IZ = 483				
			Table 5.3 Moment of Inertia (Pound-Inches-Squared) - Electronics Box & Brake Cutter (Incl. Brake/Tensionmeter Cable): IX = 138, IY = 101 & IZ = 163				
			Table 5.3 Moment of Inertia (Pound-Inches-Squared) - Core Cable: IX = 0, IY = 4 & IZ = 4				
			Table 5.3 Origin Point for the Center of Gravity - Deployer/Tether & Canister Cable: From the geometric center of the flat bottom of the canister				
			Table 5.3 Origin Point for the Center of Gravity - El Box & Brake Cutter & Brake/Tensionmeter Cable: From the corner of the el box at the attach surface				
			Table 5.3 Origin Point for the Center of Gravity - Core Cable: From the geometric center of the flat bottom of the deployer canister				
S3.10.1	3.10.1		<b>Mass Properties</b>	A,T	A) EL42 (01-94), SEDS-2 Mass Properties, 1/5/94		CLOSED
			The DS weight, cg and moments of inertia shall be supplied to MDA.				
		2	<b>Mass Properties</b>	A,T	A) EL42 (01-94), SEDS-2 Mass Properties, 1/5/94		CLOSED
			Verify the weight of the Electronics Box				
			Verify the weight of the Brake/Cutter Assembly				
			Verify the weight of the Deployer/Tether				
			Verify the center of gravity (CG) of the Electronics Box				
			Verify the center of gravity (CG) of the Brake/Cutter Assembly				

2.4 - 45

**VERIFICATION REQUIREMENTS COMPLIANCE**

SRD/IRD REQ	CEI REQ	VRSD REQ	REQUIREMENT STATEMENT	COMP. METH.	COMPLIANCE DATA	NON-CONF.	COMMENTS/REMARKS
			Verify the center of gravity (CG) of the Deployer/Tether				
			Verify the moment of inertia (MOI) of the Electronics Box				
			Verify the moment of inertia (MOI) of the Brake/Cutter Assembly				
			Verify the moment of inertia (MOI) of the Deployer/Tether				
I5.0			<b>SEDS-2/DELTA II Mechanical Interfaces</b>				CLOSED
I5.1			<b>Attachment Description</b>				CLOSED
			Three SEDS-2 pieces of hardware shall be attached to the MDA built brackets. These shall be: (1) the deployer which shall be bolted to the support beam in 8 places; (2) the electronics box which shall be bolted to the longerons in four places; and (3) the endmass which shall be bolted to the payload adapter in six places. Figure 5.1 illustrates the SEDS-2 hardware geometry when assembled on the Delta II guidance section and shows the correct flight orientation.				
I5.1.1			<b>Deployer</b>				CLOSED
			The deployer shall be bolted to the MDA support beams (1D71106) using four (NAS1003) bolts and four (NAS1004) bolts.				
			These bolts shall be provided by MDA.				
			The torque shall be 20-25 in-lbs and 50-70 in-lbs respectively.				
			Figure 5.1.1-1 shows the MDA interface for the deployer.				
			The deployer interface hole pattern is shown in Figure 5.1.1-2.				
I5.1.2			<b>Electronics Box/Brake Cutter</b>				CLOSED



**VERIFICATION REQUIREMENTS COMPLIANCE**

SRD/IRD REQ	CEI REQ	VRSD REQ	REQUIREMENT STATEMENT	COMP. METH.	COMPLIANCE DATA	NON- CONF.	COMMENTS/ REMARKS
			The electronics box shall be bolted to the MDA support longerons (1D71104) using four (NAS1351N3) bolts provided by MDA.				
			The torque shall be 20-25 in-lbs.				
			Figure 5.1.1-1 shows the MDA interface for the electronics box.				
			The electronics box interface hole pattern is shown in Figure 5.1.2.				
			The inert pyrotechnic NSI charges and connectors for the tether cutter shall be installed before the deployer is mated to the second stage. MSFC shall be responsible for the installation of the MSFC-supplied tether cutter pyrotechnic NSI's.				
			The inert pyrotechnic NSI will be electrically connected after mating.				
I5.2			<b>Size and Fairing Envelope</b>				CLOSED
			Near the second stage guidance section where the SEDS-2 experiment is mounted, the Delta II fairing has a maximum static payload envelope radius of 45.3 inches. This envelope accounts for the spacecraft dynamic deflections but				
			does not include spacecraft tolerances. SEDS-2 shall not extend beyond this envelope.				
			A 1.0 inch minimum clearance is required by the USAF (after accounting for deflection and tolerances).				
S3.10.2	3.10.2		<b>Envelope</b>	R,I	A) MDA SEDS-2 Technical Interchange Meeting December 2, 1993		CLOSED

**UNCLASSIFIED**

**VERIFICATION REQUIREMENTS COMPLIANCE**

SRD/IRD REQ	CEI REQ	VRSD REQ	REQUIREMENT STATEMENT	COMP. METH.	COMPLIANCE DATA	NON-CONF.	COMMENTS/REMARKS
			The DS, in the stowed position, shall not violate statically or dynamically the Delta II second stage envelope as defined inMDC 93H0141.		B) On Pad Inspection, 3/4/94		
			The SEDS-2 DS is required to be located on the Delta II second stage guidance section above the mini-skirt and between the access panels.				
			Where the SEDS-2 experiment is mounted, the Delta II fairing has a maximum static payload envelope radius of 45.5 inches.				
			A 1.0 inch minimum clearance is required between the SEDS-2 DS and the spacecraft fairing (after accounting for deflections and tolerances).				
			The SEDS-2 deployer shall be attached to the Delta II with MDA support brackets.				
			The SEDS-2 electronics box shall be attached to the Delta II with MDA longerons.				
S3.11	3.11		<b>Operational Availability</b>	N/A			CLOSED
S3.11.1	3.11.1		<b>Usage Life</b>	N/A			CLOSED
			The DS is an expendable system and shall have a usage life of one mission.				
			The shelf life is limited by the tether which requires rewinding after 6 months.				
S3.11.2	3.11.2		<b>On-pad Stay Time</b>	N/A			CLOSED
			The DS on-pad stay time shall be defined by that of the SEDS-2 Endmass battery.				
S3.12	3.12		<b>Safety</b>	R,A,I	A) Memo EB34 (94-07), SEDS-2 Electronics Box Hardware Review, M. Teal to F. Smith, 2/1/94		CLOSED

2.4 - 48

**VERIFICATION REQUIREMENTS COMPLIANCE**

SRD/IRD REQ	CEI REQ	VRSD REQ	REQUIREMENT STATEMENT	COMP. METH.	COMPLIANCE DATA	NON-CONF.	COMMENTS/REMARKS
			The DS shall be designed to ensure compliance with Range Safety Manual (ESMCR 127-1) Chapters 3 and 5, Safety, Reliability, and Quality Assurance Programs, (KMI 1710.1) and the Consolidated Space Test Command Regulation (CSTCR 127-1) Space Test Safety.		B) Air Force Memo, From 45SPW/SESM To Tom Rucci, 1/10/94		MSPSP Replaces SEDS-2 Safety Plan
			The DS shall also comply with the KSC Ground Safety Handbook (KHB 1700.7) and the SEDS-2 Safety Plan (TBD).		C) MSPSP		
S3.13	3.13		<b>Quality</b>	N/A			CLOSED
	3.13.1		<b>Operations Performed by the Contractor</b>	I	A) Memo CQ03(05-94), Memo For Record		CLOSED
			The SEDS-2 DS Program activities, performed by the contractor, shall conform to the requirements set forth in NHB5300.4(1C), Inspection System Provisions for Aeronautical and Space System Materials,				Waiver W-91-871B Quality Coverage Prior to 5/1/91
			Parts, Components and Services, Paragraphs 1C202, 1C203, 1C204, 1C300, 1C303, 1C304, 1C305, 1C307, 1C309 (revised), and 1C310.				
			The requirements set forth in Para. 1C309, Nonconforming Articles and Material Controls, shall be revised to read: The Contractor shall control and process nonconforming materials in accordance with NHB5300.4(1C), para. 1C309,				
			"Nonconforming Articles and Materials Controls", to the extent specified below:				
			(1) Verify that material/hardware discrepancies are reported within contract requirements.				

**FOR RELEASE**

2.4 - 49

**VERIFICATION REQUIREMENTS COMPLIANCE**

<b>SRD/IRD REQ</b>	<b>CEI REQ</b>	<b>VRSD REQ</b>	<b>REQUIREMENT STATEMENT</b>	<b>COMP. METH.</b>	<b>COMPLIANCE DATA</b>	<b>NON-CONF.</b>	<b>COMMENTS/REMARKS</b>
			(2) Assure that the nonconforming flow, identified as nonconforming, and protected to prevent damage or unauthorized use.				
			(3) Inspect reworks and repairs, verify test results related to the discrepancy dispositions, and assure that the results are documented on the nonconforming report.				
	3.13.2		<b>Operations Performed In-House at MSFC</b>	I	A) Memo CQ03(05-94), Memo For Record		CLOSED
			The SEDS-2 DS program activities, performed in-house by MSFC on-site contractor personnel, shall conform to the requirements set forth in CQ5300.36B, "MSFC Quality Assurance Plan for Flight Hardware During In-house Operations."				Waiver W-91-871B Quality Coverage Prior to 5/1/91
S3.14	3.14		<b>Environment</b>	N/A			CLOSED
			The DS shall be capable of withstanding, without physical or functional degradation, the natural and induced launch and on-orbit environments as specified herein.				
S3.14.1	3.14.1		<b>Natural Environment</b>	N/A			CLOSED
S3.14.1.1	3.14.1.1		<b>Radiation</b>	A	A) Memo E513 (07-93), From B. McPeak to T. Little, 2/8/93		CLOSED
			The DS shall be able to withstand exposure to the on-orbit ionizing particle radiation environment as specified in NASA TM-82478 for the lifetime of the mission.				
S3.14.2	3.14.2		<b>Induced Environment</b>	N/A			CLOSED

2.4 - 50

**VERIFICATION REQUIREMENTS COMPLIANCE**

SRD/IRD REQ	CEI REQ	VRSD REQ	REQUIREMENT STATEMENT	COMP. METH.	COMPLIANCE DATA	NON-CONF.	COMMENTS/REMARKS
			The DS shall be capable of surviving any environment or combination of environments specified in section 3.14 of this document.				
16.7			<b>Delta II RF Systems</b>				CLOSED
			The Delta II shall have (a) 3 S-band T/M systems (one on each stage), (b) 3 Command Destruct Receivers (one on the first and 2 on the second stage), and (c) a C-Band Transponder on the second stage.				
			Delta II RF systems shall be switched to internal power a few minutes before launch and remain ON until a command OFF inflight, or the battery is depleted (the battery has margin for error in excess of mission requirements).				
			The Delta II RF environment shall be as specified in Table 6.7.				
			Table 6.7 Delta II RF Environment: Frequency 10kHz to 5.72GHz = E-Field 5 volts/meter				
			Table 6.7 Delta II RF Environment: Frequency 5.762 to 5.768 GHz* = E-Field 40 volts/meter *Vehicle C-Band transponder				
			Table 6.7 Delta II RF Environment: Frequency 5.768 to 40GHz = E-Field 5 volts/meter				
			MSFC has verified susceptibility by testing identical hardware.				
			Additionally, MSFC has determined the radiated emissions of the SEDS-2 per MIL-STD-461B Radiated Emissions Test 2.				
			Exceedances were identified to MDA for evaluation and accepted.				

2.4 - 51

**VERIFICATION REQUIREMENTS COMPLIANCE**

SRD/IRD REQ	CEI REQ	VRSD REQ	REQUIREMENT STATEMENT	COMP. METH.	COMPLIANCE DATA	NON-CONF.	COMMENTS/REMARKS
S3.14.2.1	3.14.2.1		<b>RF Radiation</b>	S	A) EL56 Technical Evaluation of SEDS-1 EMC Test Report, 11/24/92	DR 6277 UNIT 1	CLOSED
			The DS shall be able to withstand exposure to the radiation environment specified inMDC 93H0141.		B) Memo 4700/92-04, SEDS-1 EMI Test Exceedances, 1/25/93		Waiver W-93-1011B Req't RS03 in 40 - 310 MHz Range
					C) SEDS/QUAL/EI93-001 SEDS-1 Flight Unit #1 Qualification Test Report		Waiver W-93-1011C Req't RS02 at 14.05 and 16 MHz
					D) SEDS/QUAL/EL93-002 SEDS-1 Flight Unit #2 Qualification Test Report		
					E) Memo EL54 (03-94), SEDS-2 EMC From T. Clark to F. Smith, 1/14/94		
I5.9			<b>Dynamic Environments</b>				CLOSED
			The SEDS-2 dynamic environment levels shall be described in the following paragraphs. Qualification testing of the SEDS-2 hardware shall use the proto-flight approach.				
S3.14.2.2	3.14.2.2		<b>Delta II</b>	N/A			CLOSED
			The DS shall, when integrated into the Delta II, withstand the maximum/minimum environmental conditions to which it shall be subjected during launch, ascent and orbital maneuvering as specified inMDC 93H0141.				Compliance to CEI Reqs. 3.14.2.2.1 thru 3.14.2.2.6 will satisfy req.
I5.9.3			<b>Structural Loads</b>				CLOSED
			The predicted maximum quasi-static loads for all SEDS-2 components are shown in Table 5.9.3.				

EXPIRED

2.4 - 52

**VERIFICATION REQUIREMENTS COMPLIANCE**

SRD/IRD REQ	CEI REQ	VRSD REQ	REQUIREMENT STATEMENT	COMP. METH.	COMPLIANCE DATA	NON-CONF.	COMMENTS/REMARKS
			Table 5.9.3 SEDS-2 Structural Loads* (Preliminary Design Load Factors). Limit Load Factors (G) for Deployer: Radial = +/-10, Tangential = +/-10 & Axial = +/- 10				
			Table 5.9.3 SEDS-2 Structural Loads* (Preliminary Design Load Factors). Limit Load Factors (G) for Electronic Box/Brake-cutter Assembly: Radial = +/-20, Tangential = +/-20 & Axial = +/-20				
			Table 5.9.3 Note 1. Loads are applicable at spacecraft center of gravity. 2. Limit load factors should be multiplied by a minimum factor of 2.0 to obtain ultimate loads. 3. Axes are relative to the Delta II vehicle. 4. Previous analysis				
			done for SEDS-1 does not have to be redone unless changes are made to the SEDS-2 hardware.				
I5.10.2			<b>Loads</b>				CLOSED
			The loads determined for SEDS-1 will be used for SEDS-2.				
I5.10.3			<b>Strength Analysis</b>				CLOSED
			Strength analysis performed for SEDS-1 applies to SEDS-2.				
S3.14.2.2.1	3.14.2.2.1		<b>Structural Loads</b>	A	A) Memo ED24-94-01, SEDS-2 Margins of Safety, L. Barker to F. Smith		CLOSED
			The DS shall withstand the lift-off loads defined inMDC 93H0141.				
I5.9.2			<b>Vibration</b>				CLOSED
			The random and sinusoidal vibration levels to be used are shown below. The protoflight levels are +3dB above maximum flight levels.				

2.4 - 53

**VERIFICATION REQUIREMENTS COMPLIANCE**

SRD/IRD REQ	CEI REQ	VRSD REQ	REQUIREMENT STATEMENT	COMP. METH.	COMPLIANCE DATA	NON- CONF.	COMMENTS/ REMARKS
IS.9.2.1			<b>Random Vibration</b>				CLOSED
			The maximum random vibration environment occurs during liftoff. The predicted maximum flight random vibration environment for SEDS-2 is shown in Tables 5.9.2.1-1 (Endmass) and 5.9.2.1-2 (Deployer-Electronics Box):				
			Table 5.9.2.1-2 Random Vibration Levels for Deployer, Electronics Box, and Brake/Cutter Assembly at the Guidance Section Skin Longeron Interface - Frequency (Hz) 10-160 = 0.001 G2/Hz Maximum Flight Level				
			Table 5.9.2.1-2 Random Vibration Levels for Deployer, Electronics Box, and Brake/Cutter Assembly at the Guidance Section Skin Longeron Interface - Frequency (Hz) 160-400 = +17.1 dB/Octave Maximum Flight Level				
			Table 5.9.2.1-2 Random Vibration Levels for Deployer, Electronics Box, and Brake/Cutter Assembly at the Guidance Section Skin Longeron Interface - Frequency (Hz) 400-700 = 0.18 G2/Hz Maximum Flight Level				
			Table 5.9.2.1-2 Random Vibration Levels for Deployer, Electronics Box, and Brake/Cutter Assembly at the Guidance Section Skin Longeron Interface - Frequency (Hz) 700-900 = -15.4 dB/Octave Maximum Flight Level				
			Table 5.9.2.1-2 Random Vibration Levels for Deployer, Electronics Box, and Brake/Cutter Assembly at the Guidance Section Skin Longeron Interface - Frequency (Hz) 900-1300 = 0.05 G2/Hz Maximum Flight Level				

**EXPIRED**



**VERIFICATION REQUIREMENTS COMPLIANCE**

SRD/IRD REQ	CEI REQ	VRSD REQ	REQUIREMENT STATEMENT	COMP. METH.	COMPLIANCE DATA	NON-CONF.	COMMENTS/REMARKS
			Table 5.9.2.1-2 Random Vibration Levels for Deployer, Electronics Box, and Brake/Cutter Assembly at the Guidance Section Skin Longeron Interface - Frequency (Hz) 1300-1500 = +12.4 dB/Octave Maximum Flight Level				
			Table 5.9.2.1-2 Random Vibration Levels for Deployer, Electronics Box, and Brake/Cutter Assembly at the Guidance Section Skin Longeron Interface - Frequency (Hz) 1400-2000 = 0.09 G2/Hz Maximum Flight Level				
			Table 5.9.2.1-2 Random Vibration Levels for Deployer, Electronics Box, and Brake/Cutter Assembly at the Guidance Section Skin Longeron Interface - Overall Grms = 12.8 Duration = 30 second/axis Three mutually perpendicular axes				
S3.14.2.2.2	3.14.2.2.2		<b>Random Vibration</b>	T	A) See VRSD Tests 1.2, 1.3 & 3.1 Below		CLOSED
			The DS shall withstand the random vibrations specified in MDC 93H0141.				
		1.2	<b>Sine Diagnostic Test</b>	T	A) MTCP-QS-SEDS-506A Procedure Unit 1		CLOSED
			Verify Diagnostic Test Levels		B) SEDS/QUAL/EL94-001 Unit #1 Qualification Test Report		
					C) PTR1-VIB, Post Test Review, Unit 1, Vibration		
					D) MTCP-QS-SEDS-506A Procedure Unit 3		
					E) SEDS/QUAL/EL94-002 Unit #3 Qualification Test Report		
					F) PTR3-VIB, Post Test Review, Unit 3, Vibration		

2.4 - 55

**VERIFICATION REQUIREMENTS COMPLIANCE**

SRD/IRD REQ	CEI REQ	VRSD REQ	REQUIREMENT STATEMENT	COMP. METH.	COMPLIANCE DATA	NON-CONF.	COMMENTS/REMARKS
		1.3	<b>Random Vibration Test</b>	T	A) MTCP-QS-SEDS-506A Procedure Unit 1		CLOSED
			Verify Accelerometer Locations		B) SEDS/QUAL/EL94-001 Unit #1 Qualification Test Report		
			Verify Vibration Test Levels		C) PTR1-VIB, Post Test Review, Unit 1, Vibration		
					D) MTCP-QS-SEDS-506A Procedure Unit 3		
					E) SEDS/QUAL/EL94-002 Unit #3 Qualification Test Report		
					F) PTR3-VIB, Post Test Review, Unit 3, Vibration		
		3.1	<b>Pre/Post Environmental</b>	T	A) MTCP-FS-SEDS-504A Procedure Unit 1		CLOSED
			Electronics Box Memory Test		B) SEDS/QUAL/EL94-001 Unit #1 Qualification Test Report		
			Verify Turn Counter Operation		C) PTR1-VIB, Post Test Review, Unit 1, Vibration		
			Verify Temperature Sensors Operation		D) MTCP-FS-SEDS-504A Procedure Unit 3		
			Verify Tether Tension Measurement		E) SEDS/QUAL/EL94-002 Unit #3 Qualification Test Report		
			Verify Brake Motor Operation		F) PTR3-VIB, Post Test Review, Unit 3, Vibration		
			Verify Turn Counter Beam Signal Strength				
15.9.2			<b>Vibration</b>				CLOSED
			The random and sinusoidal vibration levels to be used are shown below. The protoflight levels are +3dB above maximum flight levels.				
15.9.2.2			<b>Sinusoidal Vibration</b>				CLOSED

2.4 - 56

**VERIFICATION REQUIREMENTS COMPLIANCE**

SRD/IRD REQ	CEI REQ	VRSD REQ	REQUIREMENT STATEMENT	COMP. METH.	COMPLIANCE DATA	NON-CONF.	COMMENTS/REMARKS
			The maximum sinusoidal vibration environment will occur during first stage burn.				
			The predicted maximum flight sinusoidal vibration levels for all SEDS-2 components are shown in Table 5.9.2.2				
			Table 5.9.2.2 Sinusoidal Vibration, Thrust axis: 5 to 6.2 Frequency (Hz) = 0.5 in. double amplitude Level (G's-zero to peak) Sweep Rate = 4 octaves per minute				
			Table 5.9.2.2 Sinusoidal Vibration, Thrust axis: 6.2 to 100 Frequency (Hz) = 1.0 G double amplitude Level (G's-zero to peak) Sweep Rate = 4 octaves per minute				
			Table 5.9.2.2 Sinusoidal Vibration, Radial and Tangential Axis: 5 to 100 Frequency (Hz) = 0.7 G double amplitude Level (G's-zero to peak) Sweep Rate = 4 octaves per minute				
S3.14.2.2.3	3.14.2.2.3		<b>Sinusoidal Vibration</b>		A) See VRSD Tests 1.2, 1.1 & 3.1/Below		CLOSED
			The DS shall withstand the sinusoidal vibrations defined in MDC 93H0141.				
		1.2	<b>Sine Diagnostic Test</b>	T	A) MTCP-QS-SEDS-506A Procedure Unit 1		CLOSED
			Verify Diagnostic Test Levels		B) SEDS/QUAL/EL94-001 Unit #1 Qualification Test Report		
					C) PTR1-VIB, Post Test Review, Unit 1, Vibration		
					D) MTCP-QS-SEDS-506A Procedure Unit 3		
					E) SEDS/QUAL/EL94-002 Unit #3 Qualification Test Report		

2.4 - 57

**VERIFICATION REQUIREMENTS COMPLIANCE**

<b>SRD/IRD REQ</b>	<b>CEI REQ</b>	<b>VRSD REQ</b>	<b>REQUIREMENT STATEMENT</b>	<b>COMP. METH.</b>	<b>COMPLIANCE DATA</b>	<b>NON-CONF.</b>	<b>COMMENTS/REMARKS</b>
					F) PTR3-VIB, Post Test Review, Unit 3, Vibration		
		1.1	<b>Sinusoidal Vibration Test</b>	T	A) MTCP-QS-SEDS-506A Procedure Unit 1		CLOSED
			Verify Accelerometer Locations		B) SEDS/QUAL/EL94-001 Unit #1 Qualification Test Report		
			Verify Vibration Test Levels		C) PTR1-VIB, Post Test Review, Unit 1, Vibration		
					D) MTCP-QS-SEDS-506A Procedure Unit 3		CLOSED
					E) SEDS/QUAL/EL94-002 Unit #3 Qualification Test Report	DR 6355 UNIT 3	LVDT Became Loose During UNIT 3 Test
					F) PTR3-VIB, Post Test Review, Unit 3, Vibration		
		3.1	<b>Pre/Post Environmental</b>	T	A) MTCP-FS-SEDS-504A Procedure Unit 1		CLOSED
			Electronics Box Memory Test		B) SEDS/QUAL/EL94-001 Unit #1 Qualification Test Report		
			Verify Turn Counter Operation		C) PTR1-VIB, Post Test Review, Unit 1, Vibration		
			Verify Temperature Sensors Operation		D) MTCP-FS-SEDS-504A Procedure Unit 3		CLOSED
			Verify Tether Tension Measurement		E) SEDS/QUAL/EL94-002 Unit #3 Qualification Test Report	DR 6344 UNIT 3	Discrepant Phototransistor
			Verify Brake Motor Operation		F) PTR3-VIB, Post Test Review, Unit 3, Vibration	DR 6348 UNIT 3	Discrepant Thermistor
			Verify Turn Counter Beam Signal Strength				
15.9.4			<b>Shock</b>				CLOSED

**RETRACTED**

2.4-58

**VERIFICATION REQUIREMENTS COMPLIANCE**

SRD/IRD REQ	CEI REQ	VRSD REQ	REQUIREMENT STATEMENT	COMP. METH.	COMPLIANCE DATA	NON- CONF.	COMMENTS/ REMARKS
			The maximum shock for the endmass (payload) occurs when the two pyrotechnic charges are fired that release the separation clampband (pre-loaded to 1000 +/- 50 lb). The endmass shock environment at the endmass baseplate/ Marman clamp				
			interface is shown in Table 5.9.4-1.				
			The maximum shock for the SEDS-2 deployer/electronics box is created by a combination of the Delta II launch vehicle stage 1 and 2 separation and the endmass separation.				
			That shock environment, measured at the deployer longeron/bracket interface and the electronics box/longeron interface, is shown in Table 5.9.4-2.				
			Table 5.9.4-2 Deployer/Electronics Box/Brake-Cutter Assembly Shock Environment, Maximum Flight Shock Responses: Frequency 100 (Hz) = 9 G Spectrum Level (Q=10), 2 shocks/axis & Three mutually perpendicular axes				
			Table 5.9.4-2 Deployer/Electronics Box/Brake-Cutter Assembly Shock Environment, Maximum Flight Shock Responses: Frequency 100-1000 (Hz) = +12.0 dB/Octave Spectrum Level (Q=10), 2 shocks/axis & Three mutually perpendicular axes				
			Table 5.9.4-2 Deployer/Electronics Box/Brake-Cutter Assembly Shock Environment, Maximum Flight Shock Responses: Frequency 1000-1200 (Hz) = 900 G Spectrum Level (Q=10), 2 shocks/axis & Three mutually perpendicular axes				

2.4 - 59

**VERIFICATION REQUIREMENTS COMPLIANCE**

SRD/IRD REQ	CEI REQ	VRSD REQ	REQUIREMENT STATEMENT	COMP. METH.	COMPLIANCE DATA	NON-CONF.	COMMENTS/REMARKS
			Table 5.9.4-2 Deployer/Electronics Box/Brake-Cutter Assembly Shock Environment, Maximum Flight Shock Responses: Frequency 1200-1500 (Hz) = -7.6 dB/Octave Spectrum Level (Q=10), 2 shocks/axis & Three mutually perpendicular axes				
			Table 5.9.4-2 Deployer/Electronics Box/Brake-Cutter Assembly Shock Environment, Maximum Flight Shock Responses: Frequency 1500-10000 (Hz) = 680 G Spectrum Level (Q=10), 2 shocks/axis & Three mutually perpendicular axes				
S3.14.2.2.4	3.14.2.2.4		<b>Shock</b>	S	A) WYLE Data Sheet Report No. 50592, Spectrum Shock, 12/14/92		CLOSED
			The DS shall withstand the shock environment defined in MDC 93H010.		B) SEDS/QUAL/EI93-001 SEDS-1 Flight Unit #1 Qualification Test Report		
					C) SEDS/QUAL/EL93-002 SEDS-1 Flight Unit #2 Qualification Test Report		
					D) Memo ED23-91-95, Qualification Testing SEDS-1		
					E) USAF Letter Lt. Col Baird To D. Bedell "SEDS-02 Environmental Test Plan " 14 September 1993		
I5.10.4			<b>Thermal</b>				CLOSED
			A thermal analysis for lift-off/ascent, and the tether deployment period shall be conducted by MSFC with inputs required from TA. MDA will not provide mission specific thermal environment for SEDS-2.				

2.4 - 60

**VERIFICATION REQUIREMENTS COMPLIANCE**

SRD/IRD REQ	CEI REQ	VRSD REQ	REQUIREMENT STATEMENT	COMP. METH.	COMPLIANCE DATA	NON-CONF.	COMMENTS/REMARKS
S3.14.2.2.5	3.14.2.2.5		<b>Thermal</b>	A,T	A) See VRSD Analysis 4.3 & VRSD Tests 1.4 & 3.2 Below		CLOSED
			The DS shall withstand the thermal environment defined in MDC 93H0141 and NASA TM-82478.				
			Thermal analysis shall provide the temperatures used to show the structure meets requirement 3.4.1.				
		4.3	<b>Thermal Analysis</b>	A	A) Memo ED63 (59-93) SEDS-2 Post Deployment Thermal Analysis Results, From S. Kittredge To F. Smith, 1/19/94		CLOSED
			Verify Electronics Bx Temperature Does Not Exceed Limits		B) Memo ED63 (03-94) SEDS-2 Brake Assy Modeling Mod, From S. Kittredge To F. Smith, 2/3/94		
			Verify Tether (SPECTRA) Does Not Exceed Limits				
			Verify Tether (KEVLAR) Does Not Exceed Limits				
			Verify Deployer Cansiter Temperature Does Not Exceed Limits				
			Verify Brake/Cutter Assy Temperature Does Not Exceed Limits				
		1.4	<b>Thermal Vacuum Test</b>	T	A) MTCP-QS-SEDS-509A Procedure Unit 1		CLOSED
			Verify Thermocouple Locations		B) SEDS/QUAL/EL94-001 Unit #1 Qualification Test Report		
			Verify Thermal Vacuum Test Profile Data Levels		C) PTR1-TV, Post Test Review, Unit 1, Thermal Vacuum		
					D) MTCP-QS-SEDS-509A Procedure Unit 3		
					E) SEDS/QUAL/EL94-002 Unit #3 Qualification Test Report		

**EXPIRED**

**VERIFICATION REQUIREMENTS COMPLIANCE**

SRD/IRD REQ	CEI REQ	VRSD REQ	REQUIREMENT STATEMENT	COMP. METH.	COMPLIANCE DATA	NON-CONF.	COMMENTS/REMARKS
					F) PTR3-TV, Post Test Review, Unit 3, Thermal Vacuum		
		3.2	<b>Thermal Vacuum Functional</b>	T	A) MTCP-QS-SEDS-509A Procedure Unit 1		CLOSED
			Verify Tether Turn Counter Operation		B) SEDS/QUAL/EL94-001 Unit #1 Qualification Test Report		
			Verify Temperature Sensors Operation		C) PTR1-TV, Post Test Review, Unit 1, Thermal Vacuum		
			Verify Tether Position Measurement		D) MTCP-QS-SEDS-509A Procedure Unit 3		CLOSED
			Verify Brake Motor Operation		E) SEDS/QUAL/EL94-002 Unit #3 Qualification Test Report	DR 6340 UNIT 3	Discrepant Turns Count LEDs
			Verify Turn Counter Beam Signal Strength		F) PTR3-TV, Post Test Review, Unit 3, Thermal Vacuum		
S3.14.2.2.6	3.14.2.2.6		<b>Pressure</b>	S	A) Ascent Pressure Profile Portion of the Deployment Test, SEDS-1; SEDS/QUAL/EL93-001, SEDS Flight Unit #1 Qualification Test Report		CLOSED
			The DS shall withstand the pressure environment defined in MDC-H3224B.		B) Ascent Pressure Profile Portion of the Deployment Test, SEDS-1; SEDS/QUAL/EL93-002, SEDS Flight Unit #2 Qualification Test Report		
			Venting analysis shall provide the pressure differential used to show the structure meets requirement 3.4.1.		C) Venting Analysis ED33(49-91)		

2.4 - 62



**VERIFICATION REQUIREMENTS COMPLIANCE**

SRD/IRD REQ	CEI REQ	VRSD REQ	REQUIREMENT STATEMENT	COMP. METH.	COMPLIANCE DATA	NON-CONF.	COMMENTS/REMARKS
S3.14.2.3	3.14.2.3		<b>Handling and Transportation Load Factors</b>	I	A) MSFC-PLAN-2055 Packaging, Handling, And Moving Plan for SEDS Hardware, Revised 2/94		CLOSED
			The DS handling and transportation load factors shall be less than 80% of flight loads.				
			Modes of travel and shipping containers shall be used which will meet this requirement.				
S3.15	3.15		<b>Contamination Control and Cleanliness</b>	I	A) See VRSD Inspection 4.2 Below		CLOSED
			The DS hardware shall be cleaned in accordance with JSC-SN-0005 VC/Standard, Rev A, level C, before integration.				
		4.2	<b>Material</b>	I	A) Memo EH44 (94-0012), SEDS Certification Material Usage Agreement, From C. Key to J. Harrison, 2/1/94		CLOSED
			Verify hardware surfaces meet criteria for cleanliness				
S3.16	3.16		<b>Transportability/Transportation</b>	I	A) MSFC-PLAN-2055 Packaging, Handling, And Moving Plan for SEDS Hardware, Revised 2/94		CLOSED
			The DS transportation requirements are defined in the Packaging, Handling and Moving Plan for the SEDS-2 Hardware, MSFC-PLAN-TBD.				
S3.17	3.17		<b>Storage</b>	I	A) MSFC-PLAN-2055 Packaging, Handling, And Moving Plan for SEDS Hardware, Revised 2/94		CLOSED

**VERIFICATION REQUIREMENTS COMPLIANCE**

SRD/IRD REQ	CEI REQ	VRSD REQ	REQUIREMENT STATEMENT	COMP. METH.	COMPLIANCE DATA	NON-CONF.	COMMENTS/REMARKS
			During storage, the DS components and assemblies shall be packaged and preserved per paragraph 5.1.				
S3.18			<b>Design and Construction Requirements</b>				CLOSED
			The SEDS-2 DS components shall be built to the Design and Construction Requirements specified in MSFC-SPEC-2234.				
	3.18		<b>Design and Construction Requirements</b>	N/A			CLOSED
			Section 3.18 in its entirety applies only to the MSFC built SEDS-2 Electronics Box and cables. The other SEDS-2 DS components shall be built to the requirements specified in the following paragraphs of this section: 3.18.3.1, 3.18.3.3				
			(Only NHB 5300.4 (3I)), 3.18.3.4, 3.18.3.7, 3.18.3.14, 3.18.5.1, and 3.18.8.				
	3.18.1		<b>Selection of Specifications and Standards</b>	N/A			CLOSED
			The selection of specifications shall be in accordance with MM 8070.2L.				
	3.18.2		<b>General</b>	N/A			CLOSED
			All engineering documentation (including drawings) shall be prepared, approved, released, accounted for, and changed in accordance with MSFC-STD-555.				
	3.18.3		<b>Electrical</b>	N/A			CLOSED

**VERIFICATION REQUIREMENTS COMPLIANCE**

SRD/IRD REQ	CEI REQ	VRSD REQ	REQUIREMENT STATEMENT	COMP. METH.	COMPLIANCE DATA	NON-CONF.	COMMENTS/REMARKS
	3.18.3.1		<b>Crimped Connectors</b>	R,I	A) Memo EB34 (94-07), SEDS-2 Electronics Box Hardware Review, M. Teal to F. Smith, 2/1/94		CLOSED
			Electrical Crimped Connectors shall be in accordance with NHB 5300.4 (3H).		B) Memo CQ06 (94-4), SEDS-2 Configuration Verification AA04, From H. Smith to F. Smith, 2/2/94		
	3.18.3.2		<b>Soldering</b>	R,I	A) Memo EB34 (94-07), SEDS-2 Electronics Box Hardware Review, M. Teal to F. Smith, 2/1/94		CLOSED
			Soldering shall be in accordance with NHB 5300.4 (3A-1).		B) Memo CQ06 (94-4), SEDS-2 Configuration Verification AA04, From H. Smith to F. Smith, 2/2/94		
	3.18.3.3		<b>Printed Circuits</b>	R,I	A) Memo EB34 (94-07), SEDS-2 Electronics Box Hardware Review, M. Teal to F. Smith, 2/1/94		CLOSED
			Printed circuits used shall be in accordance with NHB 5300.4 (3I) and NHB 5300.4 (3K).		B) Memo CQ06 (94-4), SEDS-2 Configuration Verification AA04, From H. Smith to F. Smith, 2/2/94		
	3.18.3.4		<b>Conformal Coating</b>	R,I	A) Memo EB34 (94-07), SEDS-2 Electronics Box Hardware Review, M. Teal to F. Smith, 2/1/94		CLOSED
			Conformal coating shall be in accordance with NHB 5300.4 (3J).		B) Memo CQ06 (94-4), SEDS-2 Configuration Verification AA04, From H. Smith to F. Smith, 2/2/94		
	3.18.3.5		<b>Cable/Wiring Harnesses</b>	R,I	A) EB12 Memo, Verification Requirements Document EL45-CMPL-SEDS-2 from B. Green to F. Smith, 1/6/94		CLOSED

**FORN RELEASE**

**VERIFICATION REQUIREMENTS COMPLIANCE**

SRD/IRD REQ	CEI REQ	VRSD REQ	REQUIREMENT STATEMENT	COMP. METH.	COMPLIANCE DATA	NON-CONF.	COMMENTS/REMARKS
			The electrical networks consisting of cables, connectors, harnesses, etc., shall conform to NHB 5300.4 (3G) and shall be installed per MSFC-SPEC-494.		B) Memo CQ06 (94-4), SEDS-2 Configuration Verification AA04, From H. Smith to F. Smith, 2/2/94		W-92-994, Cable Clamps Used in EH Stores
			Electrical contact retention shall comply with MSFC-STD-781.				D-93-1074, Beam Sensor Cables W/No Vacuum Bake
			Electrical wires, cables, and harness assemblies shall be marked and identified per MSFC-SPEC-708.				TA-1, Sleeved Photosensor Assy Cable
							TA-2, Sleeved Thermistor Assy Cable
							NAS-002, Delrin Sleeve Damage
	3.18.3.6		<b>Grounding and Isolation</b>	R, T	A) EB12 Memo, Verification Requirements Document EL45-CMPL-SEDS-2 from B. Green to F. Smith, 1/6/94		CLOSED
			The DS shall have power and return isolation from the chassis.		B) MTCP-FC-SEDS-500B, UNIT 3, Performed 9/14/93		
			Wires shall be sized properly to carry the return current.		C) MTCP-FC-SEDS-500B, UNIT 1, Performed 9/3/93		
			The resistance between CPU and motor power shall be greater than one MΩ.				
			The resistance between the chassis and the input power lines and their returns shall also be greater than one MΩ.				
I6.6			<b>Bonding</b>				CLOSED
			Bonding shall be in accordance with MIL-B-5087, Class R (RF potential ) requirements, to provide less than 2.5 milliohms resistance per joint between the SEDS-2 hardware and the launch vehicle structure.				
			The SEDS-2 surfaces shall be prepared to meet these requirements.				

**RETRACTED**

**VERIFICATION REQUIREMENTS COMPLIANCE**

SRD/IRD REQ	CEI REQ	VRSD REQ	REQUIREMENT STATEMENT	COMP. METH.	COMPLIANCE DATA	NON-CONF.	COMMENTS/REMARKS
	3.18.3.7		<b>Electrical Bonding</b> SEDS-2 bonding requires compliance with MIL-B-5087. MIL-B-5087 covers in general all types of bonding between instruments and structure. The preferred method is metal-to-metal bonding of electrically active experiment equipment to the primary structure.	T	A) See VRSD Test 5.1 Below		CLOSED
		5.1	<b>Fit Check</b> Verify bonding between SEDS-2 hardware and launch vehicle structure	T	A) TPS EL64-SEDS-529, Unit #1 B) TPS EL64-SEDS-530, Unit #3		CLOSED
	3.18.3.8		<b>Individual Circuit Shielding</b> Circuit shielding shall be used to protect low level/sensitive circuits and to reduce radiation from potential high noise level circuits. Individual circuit shields shall cover twisted pairs, triplets, etc., and all of the return current shall be contained within the same shield as the outgoing current.	I	A) Memo CQ06 (94-4), SEDS-2 Configuration Verification AA04, From H. Smith to F. Smith, 2/2/94		CLOSED
	3.18.3.9		<b>Overall Shields</b> Overall shields shall be used in addition to individual shields where cabling is routed in extremely high noise environments. Overall shields shall be insulated from individual shields and shall be grounded to case or structure on at least one end.	I	A) Memo CQ06 (94-4), SEDS-2 Configuration Verification AA04, From H. Smith to F. Smith, 2/2/94		CLOSED

2.4 - 67

**VERIFICATION REQUIREMENTS COMPLIANCE**

SRD/IRD REQ	CEI REQ	VRSD REQ	REQUIREMENT STATEMENT	COMP. METH.	COMPLIANCE DATA	NON-CONF.	COMMENTS/REMARKS
	3.18.3.10		<b>Electrical Fault Protection</b>	R,I	A) EB12 Memo, Verification Requirements Document EL45-CMPL-SEDS-2 from B. Green to F. Smith, 1/6/94		CLOSED
			SEDS-2 power circuits shall be designed so that faults within the SEDS-2 or its interfaces to the Delta II will not damage Delta II circuits.		B) Memo CQ06 (94-4), SEDS-2 Configuration Verification AA04, From H. Smith to F. Smith, 2/2/94		
			The function of the fuse is primarily to protect circuit wiring.				
			The fuse is to be sized to be compatible with the current/time/temperature characteristics of the associated wiring.				
16.7			<b>Delta II RF Systems</b>				CLOSED
			The Delta II shall have (a) 3 S-band T/M systems (one on each stage), (b) 3 Command Destruct Receivers (one on the first and 2 on the second stage), and (c) a C-Band Transponder on the second stage.				
			Delta II RF systems shall be switched to internal power a few minutes before launch and remain ON until either command OFF inflight, or the battery is depleted (the battery has margin for error in excess of mission requirements).				
			The Delta II RF environment shall be as specified in Table 6.7.				
			Table 6.7 Delta II RF Environment: Frequency 10kHz to 5.72GHz = E-Field 5 volts/meter				
			Table 6.7 Delta II RF Environment: Frequency 5.762 to 5.768 GHz* = E-Field 40 volts/meter *Vehicle C-Band transponder				
			Table 6.7 Delta II RF Environment: Frequency 5.768 to 40GHz = E-Field 5 volts/meter				
			MSFC has verified susceptibility by testing identical hardware.				

UNCLASSIFIED

2.4 - 68

**VERIFICATION REQUIREMENTS COMPLIANCE**

SRD/TRD REQ	CEI REQ	VRSD REQ	REQUIREMENT STATEMENT	COMP. METH.	COMPLIANCE DATA	NON-CONF.	COMMENTS/REMARKS
			Additionally, MSFC has determined the radiated emissions of the SEDS-2 per MIL-STD-461B Radiated Emissions Test 2.				
			Exceedances were identified to MDA for evaluation and accepted.				
	3.18.3.11		<b>Electromagnetic Compatibility (EMC)</b>	S	A) EL56 Technical Evaluation of SEDS-1 EMC Test Report, 11/24/92	DR 6277	CLOSED
			The SEDS-2 shall be designed for electromagnetic soft compatibility and for electromagnetic compatibility with the Delta II in accordance with MSC 93H0141.		B) Memo 4700/92-04, SEDS-1 EMI Test Exceedances, 1/25/93		Waiver W-93-1011B Req't RS03 in 40 - 310 MHz Range
					C) SEDS/QUAL/EI93-001 SEDS-1 Flight Unit #1 Qualification Test Report		Waiver W-93-1011C Req't RS02 at 14.05 and 16 MHz
					D) SEDS/QUAL/EL93-002 SEDS-1 Flight Unit #2 Qualification Test Report		
					E) Memo EL54 (03-94), SEDS-2 EMC, From T. Clark to F. Smith 1/14/94		
	3.18.3.12		<b>Corona Suppression</b>	S	Memo EL56 (41-92), Corona Threat on the SEDS-1, Dec 4, 1992		CLOSED
			The SEDS-2 shall satisfactorily meet the requirements related to vacuum corona prevention and electrical breakdown prevention to conform with MIL-STD-454.				
			High voltage equipment shall meet the requirements in MSFC-STD-531.				
	3.18.3.13		<b>Lightning Protection</b>	N/A			CLOSED
			Not Applicable				

2.4 - 69

**VERIFICATION REQUIREMENTS COMPLIANCE**

SRD/IRD REQ	CEI REQ	VRSD REQ	REQUIREMENT STATEMENT	COMP. METH.	COMPLIANCE DATA	NON-CONF.	COMMENTS/REMARKS
	3.18.3.14		Electrical, Electronic, and Electromechanical Parts	N/A			CLOSED
	3.18.3.14a		Rescreening of JANTXV devices is no required	N/A			CLOSED
	3.18.3.14b		Microcircuits, and semiconductors shall include radiographic (x-ray) inspection and Particle Impact Noise Detection (PIND) appropriate to construction, and Destructive Physical Analysis on a selected basis.	I	A) Memo EB13 (07-93), From B. McPeak to T. Little, 2/8/93		CLOSED
	3.18.3.14c		Parts selected from MIL-STD-975 shall be the preferred selection where these parts are readily available and meet the cost constraints for the SEDS-2 program.	N/A			CLOSED
	3.18.3.14d		Nonstandard parts must be of a quality level equal to that of standard parts, and the supporting data and/or rationale shall be reviewed and approved by Science and Engineering.		A) Memo EB13 (07-93), From B. McPeak to T. Little, 2/8/93		CLOSED
			Unless otherwise specified by S&E, submittal of NSPAR's and/or DARS as applicable are required.				
			Approved EEE parts shall be listed in the SEDS-2 as-designed parts list.				
	3.18.3.14e		Nonstandard Microcircuits and Semiconductors shall be selected according to the following order of precedence: 1. Detailed Military Specification (i.e., MIL-M-XXXX), 2. Standard Military Drawing (SMD), 3. MIL-STD-883 compliant microcircuits, and 4. Source Control Drawing (SCD).	I	A) Memo EB13 (07-93), From B. McPeak to T. Little, 2/8/93		CLOSED

2.4 - 70



NUMBER	REQUIREMENT STATEMENT	SIGNAL ID	CRITERIA AND SPECIFICATIONS	CONDITIONS, CONSTRAINTS, REMARKS
a.2	Plus Direction (Redundant Motors) a) Command - Redundant Motors			
	SADE 2 + WNG CNTR ENBL	B0CD00F0		
	SADE 2 + WNG + 5.65 DEG/PUL	B0CD00F1		
	SADE 2 + WNG + .088 DEG/PUL	B0CD00F3		
	SADE 2 + WNG CNTR DSBL/ROT	B0CD00F5		
	SADE 2 - WNG + 5.65 DEG/PUL	B0CD00F8		
	SADE 2 - WNG + .088 DEG/PUL	B0CD00F9		
	SADE 2 + WNG CNTR DSBL/ROT	B0CD00FB		
	SADE 2 + WNG CNTR DSBL/ROT	B0CD00FD		
	b) Response I			
	SADE 2 + WNG MOTOR OP	B29X112B	Logical 1	Reference the remark to a.1
	SADE 2 - WNG MOTOR OP	B29X116BB	Logical 1	Response I
	SADE 1 + WNG MOTOR NOT OP	B28X102B	Logical 0	Negative Check
	SADE 1 - WNG MOTOR NOT OP	B28X106B	Logical 0	Negative Check
	Response II			
	SADE 2 + WNG MOTOR NOT OP	B29X112B	Logical 0	
	SADE 2 - WNG MOTOR NOT OP	B29X116B	Logical 0	
	SADE 1 + WNG MOTOR OP	B28X102B	Logical 0	Reference the Remark to a.1
	SADE 1 - WNG MOTOR OP	B28X106B	Logical 0	Response II
	Response III			
	SADE 1 + WNG POS	B28H301A		
	SADE 1 - WNG POS	B28H302A		
	SADE 2 + WNG POS	B29H303A	Reference a.1 Response III	reference remark to a.1 Response III
	SADE 2 - WNG POS	B29H304A	III	
a.3	Minus Direction (Main Motors) a) Command			
	SADE 1 + WNG CNTR ENBL	B0CD00E0		
	SADE 1 + WNG -5.625 DEG/PUL	B0CD00E1		
	SADE 1 + WNG - .088 DEG/PUL	B0CD00E3		
	SADE 1 + WNG CNTR DSBL/ROT	B0CD00E5		
	SADE 1 - WNG + 5.65 DEG/PUL	B0CD00E8		
	SADE 1 - WNG + .088 DEG/PUL	B0CD00E9		
	SADE 1 + WNG CNTR DSBL/ROT	B0CD00EB		
		B0CD00ED		

2.3 - 143

VERIFICATION REQUIREMENTS AND SPECIFICATIONS

NUMBER	REQUIREMENT STATEMENT	SIGNAL ID	CRITERIA AND SPECIFICATIONS	CONDITIONS, CONSTRAINTS, REMARKS
b) Response I				
	SADE 1 + WNG MOTOR OP	B29X102B	Logical 1	Reference the remark to a.1 Response I Negative Check Negative Check
	SADE 1 - WNG MOTOR OP	B29X106B	Logical 1	
	SADE 2 + WNG MOTOR NOT OP	B29X112B	Logical 0	
	SADE 2 - WNG MOTOR NOT OP	B29X116B	Logical 0	
Response II				
	SADE 1 + WNG MOTOR NOT OP	B28X102B	Logical 0 Logical 0 Logical 0 Logical 0	Reference the Remark to a.1 Response II
	SADE 1 - WNG MOTOR NOT OP	B28X106B		
	SADE 2 + WNG MOTOR NOT OP	B28X112B		
	SADE 2 - WNG MOTOR NOT OP	B29X116B		
Response III				
	SADE 1 + WNG POS	B28H301A	Reference a.1 Response	reference remark to a.1 Response III
	SADE 1 - WNG POS	B28H302A		
	SADE 2 + WNG POS	B29H303A		
	SADE 2 - WNG POS	B29H304A		
a.4	Minus Direction (Main Motors)			
a) Command				
	SADE 2+ WNG CNTR ENBL	B0CD00F0		
	SADE 2 + WNG -5.625 DEG/PUL	B0CD00F2		
	SADE 2 + WNG -.088 DEG/PUL	B0CD00F4		
	SADE 2 + WNG CNTR DSBL/ROT	B0CD00F5		
	SADE 2 - WNG + 5.65 DEG/PUL	B0CD00F6		
	SADE 2 - WNG + .088 DEG/PUL	B0CD00FA		
	SADE 2 + WNG CNTR DSBL/ROT	B0CD00FC		
		B0CD00FD		

2.3 - 144

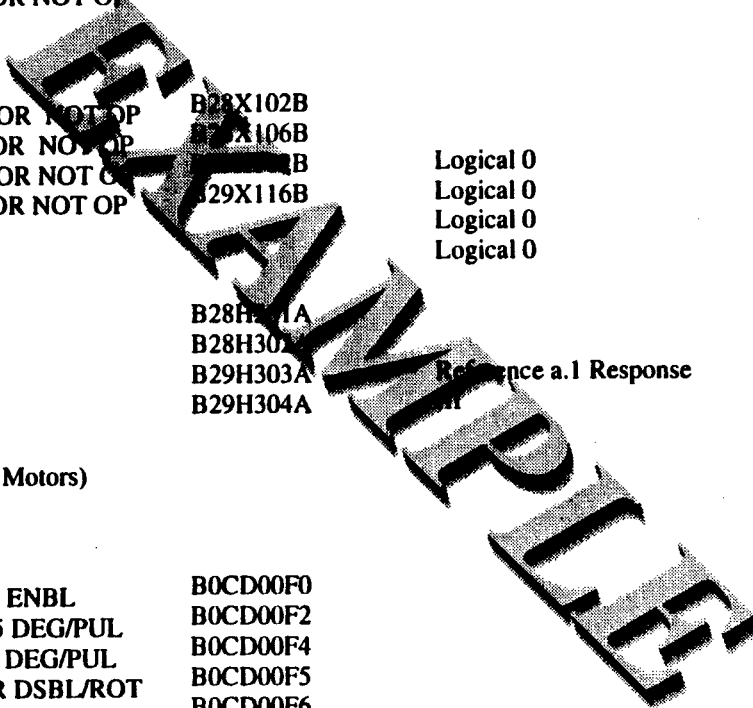

**VERIFICATION REQUIREMENTS COMPLIANCE**

SRD/IRD REQ	CEI REQ	VRSD REQ	REQUIREMENT STATEMENT	COMP. METH.	COMPLIANCE DATA	NON-CONF.	COMMENTS/REMARKS
	3.18.3.14f		Handling and transportation procedures shall be instituted to provide protection for all electrical components utilizing electrostatic discharge sensitive parts to preclude part failure resulting from handling, shipment, or storage.	I	A) MSFC-PLAN-2055 Packaging, Handling, And Moving Plan for SEDS Hardware, Revised 2/94		CLOSED
			These procedures shall meet MIL-STD-1686 or equivalent.				
	3.18.3.14g		The Parts Control Board is optional	N/A			CLOSED
	3.18.3.14h		All EEE parts shall be qualified to the piece part level and to the application.	V	A) Memo EB13 (07-93), From B. McPeak to T. Little, 2/8/93		CLOSED
			In addition, qualification for nonstandard parts shall be equivalent to standard parts.				
			The parts shall be procured only from manufacturers that are qualified or their authorized distributors.				
	3.18.3.14i		A EEE Parts Engineering List shall be maintained by each hardware developer.	I	A) Master Engineering Parts Lists, Effectivity AA004		CLOSED
			This list shall be divided into flight and GSE component sections and shall include the following information: (1) Part name (resistor, capacitor, etc.), (2) Common/similar part number, (3) Procurement specification number,				
			(4) Name of component(s) used in, and (5) Serial number when so marked.				
	3.18.3.14j		A traceability record which provides the following as-built information for each EEE part installed shall be prepared for each flight component: (1) Name of component(s) used in, (2) Part number and circuit location (R1, C4, Q2), (3) Manufacturer,	I	A) Memo CQ06 (94-4), SEDS-2 Configuration Verification AA04, From H. Smith to F. Smith, 2/2/94		CLOSED
			(4) Date code or lot number, and (5) Serial number when so marked.		B) SEDS-2 Build Records		

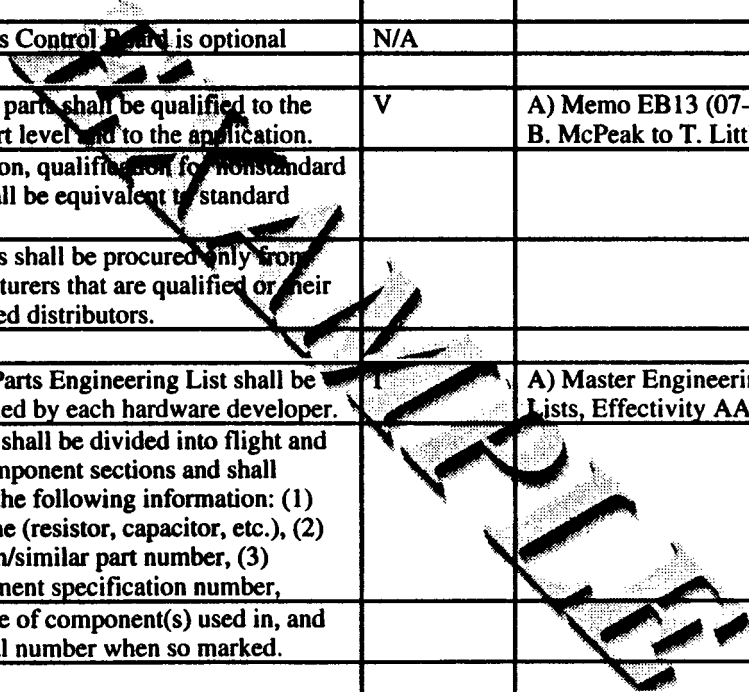

24-71

**VERIFICATION REQUIREMENTS COMPLIANCE**

SRD/IRD REQ	CEI REQ	VRSD REQ	REQUIREMENT STATEMENT	COMP. METH.	COMPLIANCE DATA	NON-CONF.	COMMENTS/REMARKS
	3.18.3.14k		An EEE parts ALERT program shall be established and implemented.	N/A			CLOSED
	3.18.4		<b>Mechanical</b>	N/A			CLOSED
	3.18.4.1		<b>Fasteners</b>	I	A) Memo CQ06 (94-4), SEDS-2 Configuration Verification AA04, From H. Smith to F. Smith, 2/2/94		CLOSED
			All threaded fasteners for safety critical structures must comply with MSFC-STD-561.				W-93-1019A, Safety Critical Fasteners
			Torque limits for threaded fasteners are in MSFC-STD-486.				None of the SEDS flight hardware is considered safety critical
			Installation of safety wire and cover pins shall be in accordance with MS 33540.				
	3.18.5		<b>Materials</b>	N/A			CLOSED
	3.18.5.1		<b>Materials and Processes</b>	A	A) Memo EH44 (94-0012), SEDS Certification Material Usage Agreement, From C. Key to J. Harrison, 2/1/94		CLOSED
			Materials, usages, and processes shall be in accordance with MSFC-STD-506.				
			Test results per MSFC-HDBK-527 shall be used to evaluate material selections.				
			All materials and processes which are not A rated require evaluation per a Materials Usage Agreement (MUA).				
	3.18.5.2		<b>Outgassing/Offgassing of Materials</b>	A,T	A) See VRSD Analysis 4.2 & VRSD Test 1.4 Below		CLOSED

24-72

**VERIFICATION REQUIREMENTS COMPLIANCE**

SRD/IRD REQ	CEI REQ	VRSD REQ	REQUIREMENT STATEMENT	COMP. METH.	COMPLIANCE DATA	NON-CONF.	COMMENTS/REMARKS
			All material and processes which are exposed to space vacuum shall meet the requirements of JSC-SP-R-0022.				
		4.2	<b>Materials</b>	A	A) Memo EH44 (94-0012), SEDS Certification Material Usage Agreement, From C. Key to J. Harrison, 2/1/94		CLOSED
			Verify materials meet thermal vacuum stability requirements				
		1.4	<b>Thermal Vacuum Test</b>	T	A) MTCP-QS-SEDS-509A Procedure Unit 1		CLOSED
			Verify Thermocouple Locations		B) SEDS/QUAL/EL94-001 Unit #1 Qualification Test Report		
			Verify Thermal Vacuum Test Profile Data Levels		C) PTR1-TV, Post Test Review, Unit 1, Thermal Vacuum		
					D) MTCP-QS-SEDS-509A Procedure Unit 3		CLOSED
					E) SEDS/QUAL/EL94-002 Unit #3 Qualification Test Report		
					F) PTR3-TV, Post Test Review, Unit 3, Thermal Vacuum		
	3.18.5.3		<b>Stress Corrosion, Cracking, &amp; Susceptibility</b>	A	A) See VRSD Analysis 4.2 Below		CLOSED
			All metallic materials shall meet the stress corrosion cracking requirements of MSFC-SPEC-522.				
			Corrosion resistant metals shall be used wherever practical.				
			MIL-HDBK-729 contains technical information and data pertaining to the corrosion and corrosion protection of metals and alloys.				

2.4-73

**VERIFICATION REQUIREMENTS COMPLIANCE**

SRD/IRD REQ	CEI REQ	VRSD REQ	REQUIREMENT STATEMENT	COMP. METH.	COMPLIANCE DATA	NON-CONF.	COMMENTS/REMARKS
		4.2	<b>Material</b>	A	A) Memo EH44 (94-0012), SEDS Certification Material Usage Agreement, From C. Key to J. Harrison, 2/1/94		CLOSED
			Verify material properties for stress corrosion cracking				
	3.18.5.4		<b>Dissimilar Metals</b>	A	A) Memo EH44 (94-0012), SEDS Certification Material Usage Agreement, From C. Key to J. Harrison, 2/1/94		CLOSED
			Dissimilar metals, as defined by MIL-STD-889 shall not be used in combination unless suitable corrosion protection is provided between the couple.				
	3.18.5.5		<b>Finish</b>	A	A) Memo EH44 (94-0012), SEDS Certification Material Usage Agreement, From C. Key to J. Harrison, 2/1/94		CLOSED
			The SEDS-2 finishes shall be in accordance with MSFC-SPEC-250.				
	3.18.5.6		<b>Flammability</b>	A	A) See VRSD Analysis 4.2 Below		CLOSED
			All non-metallic materials used in construction of the SEDS-2 shall meet the flammability requirements of NHB 8060.1.				
		4.2	<b>Material</b>	A	A) Memo EH44 (94-0012), SEDS Certification Material Usage Agreement, From C. Key to J. Harrison, 2/1/94		CLOSED
			Verify materials list and MUAs satisfy flammability requirements				

FORWARDED TO THE

2.4-74

**VERIFICATION REQUIREMENTS COMPLIANCE**

<b>SRD/IRD REQ</b>	<b>CEI REQ</b>	<b>VRSD REQ</b>	<b>REQUIREMENT STATEMENT</b>	<b>COMP. METH.</b>	<b>COMPLIANCE DATA</b>	<b>NON-CONF.</b>	<b>COMMENTS/REMARKS</b>
	3.18.5.7		<b>Brazing</b>	A	A) Memo EH44 (94-0012), SEDS Certification Material Usage Agreement, From C. Key to J. Harrison, 2/1/94		CLOSED
			All brazing shall be in accordance with MIL-B-7883.				
	3.18.6		<b>Interchangeability and Replaceability</b>	N/A			CLOSED
			Components which are replaceable shall be interchangeable in form, fit, and function.				
			The replacement of a component with its spare shall not require adjustments or realignment other than those possible with support equipment available at the point of replacement.				
			Calibration after component replacement is allowed.				
	3.18.7		<b>Identification and Marking</b>		A) Memo CQ06 (94-4), SEDS-2 Configuration Verification AA04, From H. Smith to F. Smith, 2/2/94		CLOSED
			Identification and marking shall be in accordance with the requirements of MIL-STD-130.				Unit 1 Not Re-Partmarked, Non-Flight Hardware
	3.18.8		<b>Workmanship</b>	I	A) Memo CQ06 (94-4), SEDS-2 Configuration Verification AA04, From H. Smith to F. Smith, 2/2/94		CLOSED
			SEDS-2 hardware shall meet the requirements stated in MSFC document CQ5300.36, "MSFC Quality Assurance Plan for Flight Hardware During In-house Operations."				IR Tags are generated for all contractor hardware

2.4 - 75

**VERIFICATION REQUIREMENTS COMPLIANCE**

SRD/IRD REQ	CEI REQ	VRSD REQ	REQUIREMENT STATEMENT	COMP. METH.	COMPLIANCE DATA	NON- CONF.	COMMENTS/ REMARKS
			SEDS-2 electronics assembly hardware, built at MSFC, shall be built, inspected, and accepted to the requirements stated in CQ5300.36.				
			SEDS-2 deployer hardware, built off-site by contractor personnel, shall be inspected and accepted to the requirements stated in CQ5300.36 upon receipt by MSFC.				
S3.19	3.19		<b>Logistics</b>	N/A			CLOSED
			Existing facilities and equipment belonging to the Government or Government contractors shall be utilized to the maximum extent feasible.				
S3.2	3.20		<b>Personnel and Training</b>	N/A			CLOSED
			Personnel that are not experienced in the assembly, adjustment, calibration, testing, and handling of similar aerospace hardware shall receive adequate training before beginning such tasks.				
S3.21	3.21		<b>Interface Requirements</b>	N/A			CLOSED
S3.21.1	3.21.1		<b>Interprogram</b>				
			The SEDS-2 to Delta II launch vehicle interface will be defined by MDC 93H0141.				
			The SEDS (DS and Endmass) to Delta II launch vehicle interface shall be defined by the SEDS-2 Mission Specification (MDA TBD).				
S3.21.2	3.21.2		<b>Interproject</b>	N/A			CLOSED
			The SEDS MSFC-LaRC Inter-center Agreement dated November 15, 1990 shall apply.				

2.4 - 76



## **2.5**

# **INTEGRATED PAYLOAD VERIFICATION PLAN**

## **2.5.1 INTRODUCTION**

The Integrated Payload Verification Plan is unique to Spacelab missions, comprised of several experiments integrated together. The Integrated Payload Verification Plan defines the tailored safety and interface requirements that are to be satisfied during Spacelab mission processing. The Integrated Payload Verification Plan differs from the Verification Plan shown in section 2.2 in that the Integrated Payload Verification Plan is only used for integrated Spacelab missions and pertains only to Orbiter safety and interface requirements. The Verification Plan in section 2.2 defines and describes an entire verification program for an individual experiment or a program that is not a Spacelab mission. The Integrated Payload Verification Plan example was prepared by the Teledyne Brown Engineering, Space Programs Division, for the Payload Projects office of MSFC.

**VERIFICATION REQUIREMENTS COMPLIANCE**

SRD/IRD REQ	CEI REQ	VRSD REQ	REQUIREMENT STATEMENT	COMP. METH.	COMPLIANCE DATA	NON- CONF.	COMMENTS/ REMARKS
			The only interface between the Endmass and the SEDS-2 DS shall be the tether connection.				

**EXAMPLE**

## **2.5.2**

# **INTEGRATED PAYLOAD VERIFICATION PLAN**

## **EXAMPLE**

**THIS PAGE INTENTIONALLY LEFT BLANK**

**ATMOSPHERIC LABORATORY FOR APPLICATIONS  
AND SCIENCE  
(ATLAS 3 And Subsequent Missions)**

**INTEGRATED PAYLOAD SYSTEM  
VERIFICATION PLAN  
(IPL)**

**EXAMPLE**

THIS PAGE INTENTIONALLY LEFT BLANK

## TABLE OF CONTENTS

<u>Section</u>	<u>Title</u>	<u>Page</u>
1	INTRODUCTION.....	2.5-8
1.1	Purpose.....	2.5-8
1.2	Scope.....	2.5-8
1.3	Payload Description.....	2.5-8
1.4	Applicable Documents.....	2.5-10
2	SYSTEM VERIFICATION PROGRAM DESCRIPTION.....	2.5-13
2.1	Verification Program Summary.....	2.5-13
2.2	Verification Method Selection.....	2.5-14
2.3	Documentation Requirements.....	2.5-15
3	SYSTEM VERIFICATION REQUIREMENTS.....	2.5-18
3.1	Objectives.....	2.5-18
3.2	Guidelines.....	2.5-18
3.3	Verification Requirements Format.....	2.5-19
3.4	Verification Requirement Definition Sheets.....	2.5-20
Appendix A	Verification Requirement Definition Sheets.....	2.5-26
Appendix B	Acronym and Abbreviation List.....	2.5-73
Appendix C	IPL Verification/OMRSD Requirement Matrix.....	2.5-80

### LIST OF TABLES

<u>Table</u>	<u>Title</u>	<u>Page</u>
1-1	ATLAS Experiment Payload.....	2.5-9
2-1	Verification Activity Versus Requirements Matrix.....	2.5-16
3-1	ATLAS Integrated Payload Verification Requirements.....	2.5-22



## 1. INTRODUCTION

### 1.1 PURPOSE

This document establishes the integrated payload verification requirements for the ATLAS mission. The ATLAS Mission Manager (MM) will use the requirements identified in this document to control the verification program for the mission and will monitor the verification process until all requirements are satisfied. MM, as used in this document, includes the personnel and organizations involved in payload integration activities.

### 1.2 SCOPE

The requirements of this document address the system-level verification requirements necessary to ensure the safety, the integrated payload interface, and the system compatibility of flight hardware and software, crew systems, and ground support equipment (GSE). System requirements apply when mission-peculiar equipment (MPE) or instruments are integrated with a carrier element. Requirements to be satisfied by analysis may be verified as soon as the payload design is complete with subsequent tracking of design changes. Requirements to be satisfied by test or inspection will be verified during fabrication, assembly, and Level IV, III/II, or I integration activities. Those integrated payload requirements that depend on experiment and MPE verification requirement closures will be closed subject to the review and acceptance of all applicable experiment or MPE verification requirement closures.

### 1.3 PAYLOAD DESCRIPTION

The ATLAS payload consists of experiments in the solar and atmospheric science discipline. A listing of the experiments assigned to the ATLAS mission is presented in Table 1-1. The mission requires -Z solar inertial and -Z local vertical (-Z Nadir) environments of Earth orbit.

TABLE 1-1. ATLAS SERIES EXPERIMENT PAYLOAD

DISCIPLINE	EXPERIMENT NUMBER	TITLE	ACRONYM
SOLAR SCIENCE	N008	Active Cavity Radiometer Solar Irradiance Monitor Experiment	ACR
	E021	Solar Constant	SOLCON
	E016	Solar Spectrum from 170 to 4000 nm	SOLSPEC
	N007	Solar Ultraviolet Spectral Irradiance Monitor 120 to 400 nm	SUSIM
ATMOSPHERIC SCIENCE	E004	Millimeter-Wave Atmospheric Sounder	MAS
	N009	Atmospheric Trace Molecule Spectroscopy	ATMOS

**EXAMINABLE**

1.4 APPLICABLE DOCUMENTS

The following documents, of the issue and revision indicated, are applicable to the degree specified in this document:

<u>DOCUMENT NO.</u>	<u>DOCUMENT TITLE</u>
B1-6-0121-TBE-A	MPE Design and Performance Part I CEI Specification for ATLAS 2 Structural/Mechanical MPE Assemblies
ICD 2-19001	Level II Shuttle Orbiter/Cargo Standard Interfaces
ICD-B-Mission Specific	Unique Spacelab to ATLAS Interfaces
JA-061C	Payload Mission Manager Interface and Safety Verification Requirements for Instruments, Facilities, MPE, and ECE on Space Transportation System (STS) Spacelab Payload Missions
JA-062B	Spacelab Integrated Payload System Verification Requirements
JA-418A	Payload Flight Equipment Requirements for Safety-Critical Structures
JA-447B	Mission Requirements on Facilities/Instruments/ Experiments for Space Transportation System Attached Payloads
JA-606D	Instrument Interface Agreement for MAS
JA-606E	Instrument Interface Agreement for SUSIM
JA-606F	Instrument Interface Agreement for ACR
JA-606G	Instrument Interface Agreement for ATMOS
JA-606K	Instrument Interface Agreement for SOLSPEC
JA-606M	Instrument Interface Agreement for SOLCON
JA-607D	Operations and Integration Agreement for MAS
JA-607E	Operations and Integration Agreement for SUSIM

<u>DOCUMENT NO.</u>	<u>DOCUMENT TITLE</u>
JA-607F	Operations and Integration Agreement for ACR
JA-607G	Operations and Integration Agreement for ATMOS
JA-607K	Operations and Integration Agreement for SOLSPEC
JA-607M	Operations and Integration Agreement for SOLCON
JA-609	ATLAS 3 and Subsequent Ground Integration Requirements Document (GIRD)
JA-620	ATLAS 3 and Subsequent Integrated Payload Requirements Document (IPRD)
JA-1035D	Verification Plan for MAS
JA-1035E	Verification Plan for SUSIM
JA-1035F	Verification Plan for ACR
JA-1035G	Verification Plan for ATMOS
JA-1035K	Verification Plan for SOLSPEC
JA-1035M	Verification Plan for SOLCON
JA-1143A	Verification Plan for MPE
JSC-16744	Spacelab Operational Data Book
JSC-SN-C-0005	Contamination Control Requirements for the Space Shuttle Program
KHB 1700.7B	Space Transportation System Payload Ground Safety Handbook
KSC-SOP-E-04	Connection and Disconnection of Electrical Connectors
KSC-SOP-Q-04	Support and Special Test Equipment Calibration
KSC-SOP-Q-05	Integrity Control
KSC-SOP-Q-06	Control of Non-Flight Equipment/Red Streamers
MDC W5520	Test Requirements Specification (TRS) ATLAS Series
MIL-E-5782B	Electrical Wiring, Procedures for

<u>DOCUMENT NO.</u>	<u>DOCUMENT TITLE</u>
MIL-STD-462	Electromagnetic Emission and Susceptibility, Test Methods
MIL-STD-463	EMC/EMI Definition and System of Units
MSFC-SPEC-521B	Electromagnetic Compatibility Requirements on Spacelab Payload Equipment
MSFC-STD-561	Threaded Fasteners, Securing of Safety Critical Flight Hardware Structure Used on Shuttle Payloads and Experiments
MSFC-STD-1299	Design Criteria for Flight Experiment Latches
NHB 5300.4 (3G)	Requirements for Interconnecting Cables, Harnesses, and Wiring
NSTS-07700	Space Shuttle System Payload Accommodations
NSTS 1700.7B	Safety Policy and Requirements for Payloads Using the Space Transportation System (STS)
410RPT0028	IPL Mass Properties Status Report
410RPT0170	Environmental Control Subsystem Compatibility Analysis Report
410RPT0171	Pointing and Stabilization Compatibility Analysis Report
PMIC-IR34-770 Procedures for MPE	Material/Parts/Processes Control Plan and
SL-E-0002	Electromagnetic Interference Characteristics, Requirements for Equipment
SLP/2104	Spacelab Payload Accommodation Handbook

## 2. SYSTEM VERIFICATION PROGRAM DESCRIPTION

### 2.1 VERIFICATION PROGRAM SUMMARY

The Spacelab payload verification process is based on a sequential building-block approach to accomplishing the required tasks. The program provides for the assignment of responsibilities and definition of all activities needed for verifying safety, interfaces and compatibility with other program elements and for certification that the verification requirements have been satisfied.

#### 2.1.1 Payload Component Verification

Instruments, MPE, ECE, selected software, and all assemblies integrated by a developer before delivery to the MM are also considered end items to be verified by the developers. Payload Mission Manager Verification Requirements for Instruments, Facilities, MPE, and ECE, JA-061, specifies the requirements to be satisfied before the end items delivered to the MM for integration. These requirements are intended to verify MM-imposed design and operational requirements related to safety and interfaces. This does not include demonstration that instrument scientific objectives are met.

#### 2.1.2 System Verification Planning

Development of this system verification plan began when the payload configuration was defined. An analysis was then completed to determine which requirements were applicable to the ATLAS payload and to define and/or identify the activities necessary to demonstrate that each requirement will be met. This system verification plan also includes integrating the verification requirements resulting from the safety analyses of any mission unique requirements into this overall system verification plan. The identified test and inspection requirements form the basis for subsequent development of detailed requirements for the Operation and Maintenance Requirements Specification Document (OMRSD) in the Ground Integration Requirements Document (GIRD). The analysis requirements are grouped logically in this plan to satisfy the maximum number of requirements with a minimum number of technical evaluations. This plan also specifies responsibility for meeting each verification requirement.

### 2.1.3 Payload System Verification

The necessary assessments will be performed in accordance with this verification plan and will be submitted to the designated MM organization for closeout action. This verification plan is used to define a system of monitoring the status of assessments as the reports are accepted.

The software verification requirements are expanded in software verification specifications for use in the Software Development Facility (SDF) before delivery of flight software to the MM. The SDF deals with the off-line testing of National Aeronautics and Space Administration (NASA)/NASA contractor-developed flight software and with testing of the integrated flight software set is performed in the SDF. Testing in the SDF is accomplished with simulated equipment and interfaces.

The launch site test, inspection, service, and maintenance requirements will be documented in the OMRSD. The installation and assembly requirements will be documented in the Engineering Configuration List (ECL), and associated drawings. The requirements in the OMRSD and ECL/Drawings for the ATLAS Series mission will be implemented through KSC Work Authorization Documents (WADs). Appendix C is a matrix indicating where the inspection and test verification requirements are documented.

## 2.2 VERIFICATION METHOD SELECTION

All equipment interfaces shall be verified by test, analysis, inspection, or a combination of these methods. The methods of verification and minimum criteria for use are defined in this section.

### 2.2.1 Test

Test is the actual operation of equipment under simulated conditions or the subjection of equipment to specified environments to measure responses. Testing includes measurements and demonstrations that should be submitted by a test report.

### 2.2.2 Analysis

Analysis is a technical evaluation that relates equipment design and use parameters to the prediction of actual design and operation. Analysis will be used to verify requirements where established analytical techniques are adequate to yield confidence, or where testing is impractical. Included in this category is analysis of similarity to items previously verified to the same criteria or more stringent criteria.

### 2.2.3 Inspection

Inspection is a physical measurement or visual evaluation of equipment and associated documentation. Inspection may be used to verify construction features, drawing compliance, workmanship, and physical condition. It includes determination of physical dimensions.

## 2.3 DOCUMENTATION REQUIREMENTS

General requirements for data to implement this plan are contained in Appendix A of JA-062. Specific items of documentation required to meet particular verification requirements are identified in section 3.4 of this plan.

**EXAMINABLE**



TABLE 2-1. VERIFICATION ACTIVITY VERSUS REQUIREMENTS MATRIX (Sheet 1 of 2)

VERIFICATION ACTIVITY	JA-614 VRDS NO.	HAZARD RPT. NO.
<u>ANALYSIS</u>		
<b>STRUCTURAL AND MECHANICAL</b>		
1. Mass Properties	2.1.1, 2.1.3	
2. Structural Dynamics		G-5
3. Structural Design Compatibility	2.2.3	G-5
4. Compatibility Assessment	2.1.1	
5. Dynamics Analysis	2.3.11	I-1
6. Drawing Inspection	2.3.20	G-5
<b>ELECTRICAL NETWORKS AND POWER</b>		
1. Static Voltage Drop Analysis	3.1.6	
2. Power Draw Analysis	3.2.1, 3.2.2	
3. Integrated EMI Analysis	1.4.1	I-2, G-2
<b>THERMAL AND ENVIRONMENTAL CONTROL</b>		
1. Environmental Control Systems Analysis	5.3.1, 5.3.3, 5.3.5, 5.4.1, 5.4.2, 5.4.4, 5.4.5, 5.8.2, 5.10.1	
2. Heat Transfer Analysis	5.3.4	
3. Accumulator Capability/Leakage Analysis	5.4.3	

TABLE 2-1. VERIFICATION ACTIVITY VERSUS REQUIREMENTS MATRIX (Sheet 2 of 2)

VERIFICATION ACTIVITY	JA-614 VRDS NO.	HAZARD RPT. NO.
<p><u>ANALYSIS (Conc.)</u></p> <p>EC SOFTWARE VERIFICATION</p> <p>Deleted</p> <p>GENERAL</p> <p>1. Emergency Shutdown/Stowing/Safing/ Jettison</p>	<p>7.7</p>	<p>G-5</p>

**EXAMPLE**

### 3. SYSTEM VERIFICATION REQUIREMENTS

#### 3.1 OBJECTIVES

The requirements in this plan constitute the minimum required to ensure a properly verified integrated payload. These requirements are to verify hardware and software interfaces, to verify safety-related functions, and to ensure payload compatibility.

#### 3.2 GUIDELINES

Major guidelines influencing the payload system verification requirements are:

- a. All items being integrated have been verified to the end item requirements in JA-061 before delivery.
- b. All new flight interfaces and hardware, must be verified. If broken, hardware interfaces must be reverified to the original criteria to the extent possible.
- c. GSE safety and interfaces with the flight system must be verified.
- d. Flight safety as documented on the hazard reports must be verified.
- e. Interface verification must ensure wiring continuity and functional operation across the interface. Pin-to-pin continuity will be checked for power cables, and functional operation will be checked for signal cables.
- f. Inspection requirements in this document are mandatory verification items. Additional inspection points, if any, may be specified in lower level documents.
- g. Instrument testing to verify that the equipment meets its scientific and/or functional objectives is not a function of this verification plan.
- h. Verification of payload to Spacelab/Orbiter compatibility is required.
- i. System verification requirements apply when MPE or instruments are integrated with a carrier element.
- j. All items of Spacelab equipment being integrated have been verified to the applicable OMRSD and McDonnell Douglas Astronautics Company (MDAC) drawings.

#### 3.3 VERIFICATION REQUIREMENTS FORMAT

Section 3.4 contains the payload verification requirements for the ATLAS Series. This section describes the organization and format of those requirements.

##### 3.3.1 Top-Level Categories

Subsystem

- 1.0 General System/Subsystem
- 2.0 Structural/Mechanical
- 3.0 Electrical Networks and Power
- 4.0 Command and Data Management
- 5.0 Environmental Control
- 6.0 Pointing Systems and Alignment
- 7.0 Crew Systems
- 8.0 EC Software Validation
- 9.0 System Validation
- 10.0 Ground Support Equipment
- 11.0 Materials and Processes

3.3.2 Definition of Column Headings for Verification Requirements Table (Table 3-1)

Column Heading

Definition

REQUIREMENT NO.

Identifies verification requirements for organization and for easy reference in other documentation. These numbers correspond to the identification numbers given in JA-062.

REQUIREMENT TITLE

Title of the JA-062 verification requirement.

METHOD

Indicates the verification technique to be used to satisfy the requirement. "T" is for test, "A" is for analysis, and "I" is for inspection.

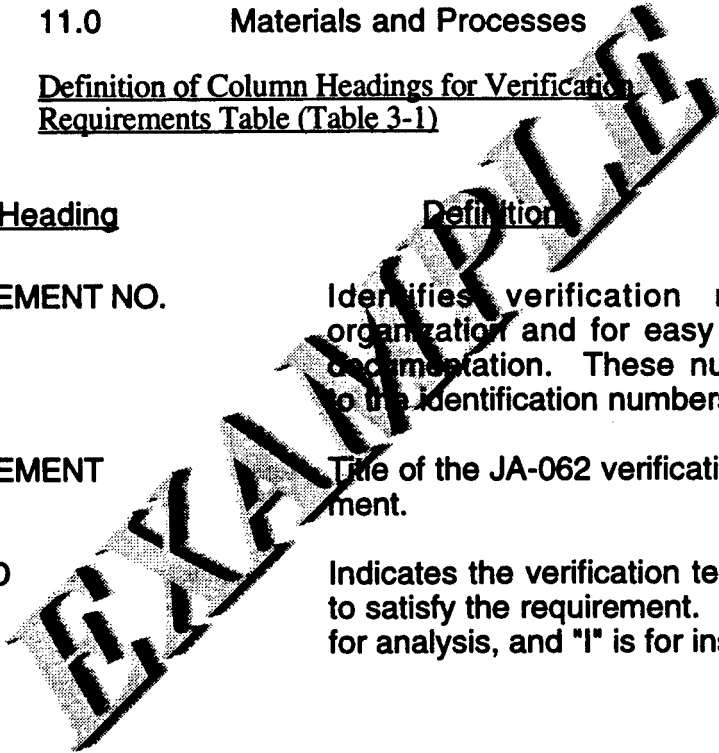

**SAFETY**

"Yes" indicates that the requirement deals with the verification of an item or function that is potentially hazardous to the crew and/or flight vehicle. Requirements so designated will be documented on hazard reports and tracked to ensure closeout. Once it has been determined by safety reviews that no hazard exists an N/A will be placed in the column.

**ACTIVITY/  
EVENT**

The time by which verification documentation must be submitted to the MM. The dates are given in terms of milestones in the review and integration process. Documentation for requirements to be verified at KSC is due at the end of the integration level given in this column.

**3.4 VERIFICATION REQUIREMENT DEFINITION SHEET**

This section contains the verification requirement definition sheets (VRDSs) for the ATLAS integrated payload system. Top-level categories identified on the VRDS sheets are the same as those for the summary table (section 3.3.2). The VRDSs are included in Appendix A of this document. The detailed identification numbering system for these requirements conforms to that used in JA-062. The main entries on the VRDSs are described below.

**ENTRY HEADING**

**DEFINITION**

**REQUIREMENT  
TITLE**

Same as for Table 3-1.

**METHOD**

Indicates the verification technique to be used to satisfy the requirement. "T" is for test, "A" is for analysis, "I" is for inspection. In some cases, more than one verification technique will be required and indicated as "T and I."

**SAFETY**

Same as for Table 3-1.

**VERIFICATION  
REQUIREMENT**

A statement of the verification requirement that must be satisfied.

DESCRIPTION OF  
REQUIREMENT

Clarifying notes, constraints, cautions,  
etc.

DATA  
REQUIRED

The documentation to be provided that  
will form the basis for closing out this  
requirement.

APPLICABLE  
DOCUMENTS AND  
NOTES

A list of those documents that are either  
a source for this requirement or specify  
the manner in which it is to be met and  
any notes pertaining to the requirement.

RESPONSIBLE  
PERSON/ORG

The person and organization  
responsible for providing the analysis  
verification documentation, and  
reviewing the test and inspection  
documentation.

DATA SUBMITTAL  
DATE

Same as ACTIVITY/EVENT in Table 3-1.

**EXAMPLE**

TABLE 3-1. ATLAS INTEGRATED PAYLOAD VERIFICATION REQUIREMENTS  
(Sheet 1 of 4)

NUM	TITLE	METHOD	SAFETY HAZ REP #	ACTIVITY/ EVENT	RESPONSIBLE GROUP(S)
<b>1.0</b>	<b>GENERAL SYSTEM/SUBSYSTEM</b>				
<b>1.1</b>	<b>Reverification of Broken Interfaces</b>				
1.1.1	Separated Interfaces (planned)	T	N/A	L-IV, III/II, I	Gnd Ops
1.1.2	Separated Interfaces (unplanned)	T	N/A	L-IV, III/II, I	Gnd Ops
<b>1.2</b>	<b>Certification of Test Equipment &amp; GSE</b>	I	N/A	IRR, L-IV, III/II, I	Gnd Ops
<b>1.3</b>	<b>Bonding</b>	A&T	N/A	IRR, L-IV, III/II	Elect.
<b>1.4</b>	<b>Electromagnetic Properties</b>				
1.4.1	EMI Emission	A	G-2, I-2	IRR	Elect.
<b>1.5</b>	<b>System Compatibility</b>				
1.5.2	Surface Cleanliness	I	N/A	IRR, L-IV, III/II, I	Gnd Ops
1.5.3	Mission Sequence Tests	T	N/A	L-III/II	CDMS/Oper
<b>1.6</b>	<b>Nonflight Equipment Removal</b>	I	N/A	IRR, IV	Gnd Ops
<b>1.7</b>	<b>Equipment Installation</b>				
1.7.2	Equipment Functional Checkout	T	N/A	L-IV, III/II, I	Gnd Ops, Design
<b>1.9</b>	<b>Time/Cycle Critical Components</b>		N/A	L-IV, III/II, I	Gnd Ops, Timelines
<b>1.10</b>	<b>Postmission</b>				
1.10.1	Equipment Removal Capability	N/A	N/A	N/A	N/A
<b>2.0</b>	<b>STRUCTURAL &amp; MECHANICAL</b>				
<b>2.1</b>	<b>Mass Properties</b>				
2.1.1	Integrated Payload Items Weights	A	NA	IRR, L-IV, III/II	Mass Properties
2.1.3	Integrated Payload Items Center of Gravity	A	N/A	IRR, L-IV	Mass Properties
<b>2.3</b>	<b>Mechanical Properties &amp; Installation</b>				
2.3.11	Physical Interference	A	I-1	IRR, LIV, III/II	MechDgn
2.3.20	Safety-Critical Fasteners	A	G-5	IRR, L-IV, III/II, I	Gnd Ops, Mech Dgn

TABLE 3-1. ATLAS INTEGRATED PAYLOAD VERIFICATION REQUIREMENTS  
(Sheet 2 of 4)

NUM	TITLE	METHOD	SAFETY HAZ REP #	ACTIVITY/ EVENT	RESPONSIBLE GROUP(S)
3.0	<b>ELECTRICAL NETWORKS AND POWER</b>				
3.1	<b>Integrated Electrical Networks</b>				
3.1.2	Continuity of Installed Harnesses	T	N/A	L-IV, III/II	Elect.
3.1.5	Electrical Isolation	T	N/A	IRR, L-IV, III/II	Elect.
3.1.6	Minimum Voltage	A&T	N/A	IRR	Elect.
3.2	<b>Electrical Power Parameters</b>				
3.2.1	Phase-to-Phase Balance	A&T	N/A	IRR, L-IV, III/II	Elect.
3.2.2	Power Draw	A&T	N/A	IRR, L-IV, III/II	Elect.
3.2.3	Experiment Power Distribution	T	N/A	L-IV, III/II	Elect.
4.0	<b>COMMAND AND DATA MANAGEMENT</b>				
4.2	<b>POCC Payload Command Capability</b>	T	N/A	L-I	CDMS
4.3	<b>POCC High Rate Data Capability to Payload</b>	T	N/A	L-I	CDMS
5.0	<b>THERMAL AND ENVIRONMENTAL CONTROL</b>				
5.1	<b>Avionics Air Distribution</b>				
5.2	<b>Payload-Provided Cooling Loop</b>				
5.2.1	Coolant	I	N/A	LIV	EC/Thermal, Gnd Ops
5.2.2	Coolant Loop Leaks	T	MPE-2	LIV	EC/Thermal, Gnd Ops
5.3	<b>Experiment Equipment MPE and MDE</b>				
5.3.4	Loss of Cooling	A	N/A	IRR	EC/Thermal, Gnd Ops
5.3.5	Exposed Surfaces	A	N/A	IRR	EC/Thermal
5.4	<b>Spacelab Freon Cooling Loop</b>				
5.4.1	Total Pressure Drop	A&T	N/A	IRR, LIV	EC/Thermal, Gnd Ops
5.4.2	Max. System Pressure	A	MPE-2	IRR	EC/Thermal, Structures



TABLE 3-1. ATLAS INTEGRATED PAYLOAD VERIFICATION REQUIREMENTS  
(Sheet 3 of 4)

NUM	TITLE	METHOD	SAFETY HAZ REP #	ACTIVITY/ EVENT	RESPONSIBLE GROUP(S)
5.4.3	System Volume	A	N/A	IRR	EC/Thermal, Structures EC/Thermal
5.4.4	Freon Loop Temperature	A	N/A	IRR	
<b>6.0</b>	<b>POINTING &amp; ALIGNMENT</b>				
<b>6.1</b>	<b>Alignment Targets</b>	T	N/A	L-IV	Point/Align.
<b>6.3</b>	<b>Instruments</b>				
6.3.1	Mechanical Alignment	T	N/A	L-IV, III/II	Pointing & Align. Pointing & Align.
6.3.2	Instrument Position	T	N/A	LIV, III/II	
<b>7.0</b>	<b>CREW SYSTEMS</b>				
7.7	Emergency Shutdown/ Stowage/Safing/Jettison	A	G-5	IRR, IV, III	Operations
<b>9.0</b>	<b>SYSTEM VALIDATION</b>				
<b>9.2</b>	<b>System Interface Validation</b>				
<b>9.2.1</b>	<b>RAU Interface (for each Instrument RAU)</b>				
9.2.1.2	Assigned Channel Outputs	N/A	N/A	N/A	N/A
9.2.1.3	Assigned Channel Inputs	N/A	N/A	N/A	N/A
<b>9.2.5</b>	<b>DDU/KB Interface</b>				
9.2.5.2	KB Commands	N/A	N/A	N/A	N/A
9.2.5.3	Function Key Inputs	N/A	N/A	N/A	N/A
9.2.5.4	Display Allocations and Display Pages	N/A	N/A	N/A	N/A
<b>9.2.6</b>	<b>MMU Interface</b>				
9.2.6.2	Input Data Transfer to MMU	N/A	N/A	N/A	N/A
9.2.6.3	Output Data Transfer from MMU	N/A	N/A	N/A	N/A
9.2.6.5	DEP Load Operations from MMU	N/A	N/A	N/A	N/A
<b>9.2.7</b>	<b>HRM Interface</b>				
9.2.7.1	ECIO Data System	N/A	N/A	N/A	N/A
<b>9.2.11</b>	<b>Experiment Computer (EC) Control of Experiments</b>				
9.2.11.1	EC Software	N/A	N/A	N/A	N/A

TABLE 3-1. ATLAS INTEGRATED PAYLOAD VERIFICATION REQUIREMENTS  
(Sheet 4 of 4)

NUM	TITLE	METHOD	SAFETY HAZ REP #	ACTIVITY/ EVENT	RESPONSIBLE GROUP(S)
9.3	Integrated System Validation				
9.3.2	Experiment Computer/IOU Data Transfer Test				
9.3.2.1	EC Mission S/W/CPU/IOU Data Transfer	N/A	N/A	N/A	N/A
9.3.3	Experiment Data Bus Data Transfer Test				
9.3.3.1	Data Bus Operation	N/A	N/A	N/A	N/A

**EXAMPLE**

**APPENDIX A**  
**VERIFICATION REQUIREMENT**  
**DEFINITION SHEETS**

**EXAMPLE**

MISSION ATLAS	VERIFICATION REQUIREMENTS DEFINITION SHEET	PAYLOAD ELEMENT IPL
REQUIREMENT NO. 1. 1. 1	REQUIREMENT TITLE SEPARATED INTERFACES (PLANNED)	METHOD T
<p><b>VERIFICATION REQUIREMENT:</b></p> <p>All interfaces separated on a planned basis after verification shall be reverified to the original criteria after remating.</p> <p><b>DESCRIPTION OF REQUIREMENT:</b></p> <p>The physical and functional mating requirements specified for any interface must be verified whenever the interfaces are joined. If the breaking of an interface is planned, the design interface requirements must be well specified, so the remated interface can be reverified to the given physical and functional requirements. These verification test requirements will be specified in the OMRSD in the GAD and implemented through applicable KSC WAD.</p> <p><b>DATA REQUIRED:</b></p> <p>OMRSD Baseline.</p> <p><b>APPLICABLE DOCUMENTS AND NOTES:</b></p> <p>GIRD, JA-609 ATLAS Mission Drawing Tree</p> <p><b>RESPONSIBLE PERSON:</b> <u>Lead ATLAS Design Engineer</u>      <b>ORG:</b> <u>TBE/PMIC</u> (TECHNICAL RESPONSIBILITY)</p> <p><b>PHONE NO:</b> <u>726-2877</u>      <b>DATA SUBMITTAL DATE:</b> <u>See Table 3-1</u></p>		

**EXAMPLE**

MISSION ATLAS	VERIFICATION REQUIREMENTS DEFINITION SHEET	PAYLOAD ELEMENT IPL
REQUIREMENT NO. 1.1.2	REQUIREMENT TITLE SEPARATED INTERFACES (UNPLANNED)	METHOD T

**VERIFICATION REQUIREMENT:**

Interfaces separated on an unplanned basis after verification shall be reverified to the extent possible. As a minimum, caution and warning and safety-critical interfaces shall be completely reverified to the original criteria.

**DESCRIPTION OF REQUIREMENT:**

If the breaking of an interface is unplanned, a WAD will be written in response to a Problem Report re-verifying the interface using the same criteria as initial verification if safety-critical or to the extent possible if not safety-critical. A constraint requirement will be included in the OMRSD in the GIRD.

**DATA REQUIRED:**

OMRSD Baseline.

**EXAMPLE**

**APPLICABLE DOCUMENTS AND NOTES:**

KSC-SOP-E-04  
GIRD, JA-609

RESPONSIBLE PERSON: Lead ATLAS Design Engineer      ORG: TBE/PMIC  
(TECHNICAL RESPONSIBILITY)

PHONE NO: 726-2877      DATA SUBMITTAL DATE: See Table 3-1

<p>MISSION ATLAS</p>	<p>VERIFICATION REQUIREMENTS DEFINITION SHEET</p>	<p>PAYLOAD ELEMENT IPL</p>
<p>REQUIREMENT NO. 1.3</p>	<p>REQUIREMENT TITLE BONDING</p>	<p>METHOD A</p>

**VERIFICATION REQUIREMENT:**

Verify that bonding test requirements are specified on the Assembly and Installation (A&I) Drawings and are properly transposed to the implementing KSC WAD(s). Verify adequate bonding of all equipment to basic structure. All electrical equipment enclosures pose an RF potential problem. Therefore, the resistance shall be 2.5 milliohms or less per joint in any single path between the enclosure. Nonelectrical equipment poses a static discharge or arcing problem. Therefore, the resistance shall be less than 1 ohm between basic structure and equipment exposed to astronauts or equipment exposed in an area where arcing would create a combustion hazard.

**DESCRIPTION OF REQUIREMENT:**

**RF POTENTIAL** - Verify a complete bonding path for all electrical equipment enclosure to basic structure. Measurements of equal to or less than 2.5 milliohms shall be required at each joint or combination of joints in any single path between the electrical enclosure and spacecraft structure.

**STATIC CHARGE** - Verify electrical bonding across joints from nonelectrical equipment or structure to basic structure for any item capable of building up static charge that could cause an arc or shock if not adequately bonded. This includes conductive structures longer than 3 in. that may be touched by an astronaut, fluid carrying pipes or ducts, cable trays, and multilayer insulation.

**DATA REQUIRED:**

Integrated Payload analysis report.

**APPLICABLE DOCUMENTS AND NOTES:**

IPRD, JA-620  
SLP/2104, SPAH, para. 7.7.2.2.1  
ATLAS Engineer Configuration List

**RESPONSIBLE PERSON:** Lead ATLAS Electrical Engineer      **ORG:** TBE/PMIC  
(TECHNICAL RESPONSIBILITY)

**PHONE NO:** 726-5150      **DATA SUBMITTAL DATE:** See Table 3-1

MISSION ATLAS	VERIFICATION REQUIREMENTS DEFINITION SHEET	PAYLOAD ELEMENT IPL
REQUIREMENT NO. 1. 4. 1	REQUIREMENT TITLE EMI EMISSION	METHOD A

**VERIFICATION REQUIREMENT:**

Verify that emissions from the ATLAS payload are within specifications for:

- RF radiation
- Conducted ripple and transients
- ac magnetic fields.

**DESCRIPTION OF REQUIREMENT:**

Analysis to verify that the composite of MPE and experiment EMI emissions is less than the overall total ATLAS payload specifications as defined in MSFC-SPEC-521B. The analysis may utilize information developed for individual MPE and experiment verification plans as follows:

- VRDS 4.2.2.1, Conducted EMI Emissions
- VRDS 4.2.2.2, Radiated EMI Emissions.

**DATA REQUIRED:**

Integrated Payload Verification Analysis Report

(NOTE: These data are used to close out Payload Hazard Report, Nos. G-2 and I-2.)

EXAMINER

**APPLICABLE DOCUMENTS AND NOTES:**

NSTS 1700.7B  
MIL-STD-462  
MIL-STD-463  
JA-447

MSFC-SPEC-521B  
SL-E-0002  
JA-1143A  
JA-1035D, E, F, G, K, M

RESPONSIBLE PERSON: Lead ATLAS Electrical Engineer      ORG: TBE/PMIC  
(TECHNICAL RESPONSIBILITY)

PHONE NO: 726-5150      DATA SUBMITTAL DATE: See Table 3-1

MISSION ATLAS	VERIFICATION REQUIREMENTS DEFINITION SHEET	PAYLOAD ELEMENT IPL
REQUIREMENT NO. 1.5.2	REQUIREMENT TITLE SURFACE CLEANLINESS	METHOD I

**VERIFICATION REQUIREMENT:**

Verify that ATLAS equipment exterior surfaces are visibly clean after installation.

**DESCRIPTION OF REQUIREMENT:**

Exterior surfaces of the ATLAS payload shall be designed to provide accessibility for cleaning purposes. External payload element surfaces shall be maintained to a visibly clean level of Sensitive as defined in JSC SN-C-0005, both prior to and following, payload element installation. Surfaces of the ATLAS equipment should be inspected for cleanliness just before closing that surface. Inspection requirements will be documented in the OMRSD in the GIRD for implementation by KSC WAD.

**DATA REQUIRED:**

OMRSD Baseline.

EXAMPLE

**APPLICABLE DOCUMENTS AND NOTES:**

NSTS 077000, Vol. XIV, sec. 10.6.2.1 & 10.6.2.1.1  
SLP/2104, SPAH, sec. 7.11.2  
JSC SN-C-0005  
GIRD, JA-609

**RESPONSIBLE PERSON:** Lead ATLAS Materials Engineer      **ORG:** TBE/PMIC  
(TECHNICAL RESPONSIBILITY)

**PHONE NO:** 726-5265      **DATA SUBMITTAL DATE:** See Table 3-1



MISSION ATLAS	VERIFICATION REQUIREMENTS DEFINITION SHEET	PAYLOAD ELEMENT IPL
REQUIREMENT NO. 1. 5. 3	REQUIREMENT TITLE MISSION SEQUENCE TESTS	METHOD T

**VERIFICATION REQUIREMENT:**

Verify operation of ATLAS integrated payload equipment and validate flight software during selected portions of the mission timeline.

**DESCRIPTION OF REQUIREMENT:**

Time slices of the highly active mission timeline will be chosen to stress all flight hardware during Level III/II mission sequence tests. Software validation not satisfied by the functional checkout will be included. Test requirements will be documented in the OMRSD in the GIRD and implemented by KSC through applicable WADs.

**DATA REQUIRED:**

OMRSD Baseline.

**EXAMPLE**

**APPLICABLE DOCUMENTS AND NOTES:**

SLP/2104, SPAH, para. 4.4 and App. A, sec. 4  
MDC-C-6854 (Spacelab Software User's Guide)  
GIRD, JA-609

RESPONSIBLE PERSON: Lead ATLAS CDMS & OPS      ORG: TBE/PMIC  
(TECHNICAL RESPONSIBILITY)

PHONE NO: 726-5150      DATA SUBMITTAL DATE: See Table 3-1

MISSION ATLAS	VERIFICATION REQUIREMENTS DEFINITION SHEET	PAYLOAD ELEMENT IPL
REQUIREMENT NO. 1.6	REQUIREMENT TITLE NONFLIGHT EQUIPMENT REMOVAL	METHOD I

**VERIFICATION REQUIREMENT:**

Verify that all ATLAS nonflight payload equipment is removed from the vehicle before flight.

**DESCRIPTION OF REQUIREMENT:**

At hardware turnover (PI/MSFC to KSC), all ATLAS installed nonflight equipment/hardware must be identified. When nonflight items are to be installed after turnover, each item will be identified in the GIRD. At KSC, each nonflight item is identified by attaching a serialized red streamer. The installation of that streamer is recorded in the Red Streamer Log along with nonflight item nomenclature. When the streamer is removed, that log item is closed. The log is kept up to date in real time and should be completely closed at Pad closeout (before flight). Nonflight item control per KSC-SOP-Q-06 will be implemented by KSC through a WAD in response to the appropriate OMRSD requirement in the GIRD.

**DATA REQUIRED:**

OMRSD Baseline.

EXAMINED

**APPLICABLE DOCUMENTS AND NOTES:**

- NSTS 1700.7B
- KHB 1700.7
- KSC-SOP-Q-06
- GIRD, JA-609

RESPONSIBLE PERSON: Lead ATLAS Design Engineer      ORG: TBE/PMIC  
(TECHNICAL RESPONSIBILITY)

PHONE NO: 726-2877      DATA SUBMITTAL DATE: See Table 3-1

MISSION ATLAS	VERIFICATION REQUIREMENTS DEFINITION SHEET	PAYLOAD ELEMENT IPL
REQUIREMENT NO. 1.7.2	REQUIREMENT TITLE EQUIPMENT FUNCTIONAL CHECKOUT	METHOD T

**VERIFICATION REQUIREMENT:**

Verify that the ATLAS installed payload equipment performs in accordance with applicable functional specifications and validate software as required by Requirements Group 9.0, "Software Validation."

**DESCRIPTION OF REQUIREMENT:**

Verification testing shall be performed to complement, substantiate and/or complete the proof of compliance to specifications. Software validation testing specified in requirements Group 9.0, "Software Validation," of this document will always be required. Test verification requirements will be documented in the OMRSD in the GIRD for implementation by KSC WADs.

**DATA REQUIRED:**

1. Flight Data Tape.
2. OMRSD Baseline

EXAMPLE

**APPLICABLE DOCUMENTS AND NOTES:**

KSC-SOP-E-04  
MDC-C-6854  
GIRD, JA-609

RESPONSIBLE PERSON: Lead ATLAS Ops Engineer      ORG: TBE/PMIC  
(TECHNICAL RESPONSIBILITY)

PHONE NO: 726-5016      DATA SUBMITTAL DATE: See Table 3-1

MISSION ATLAS	VERIFICATION REQUIREMENTS DEFINITION SHEET	PAYLOAD ELEMENT IPL
REQUIREMENT NO. 1.9	REQUIREMENT TITLE TIME/CYCLE-CRITICAL COMPONENTS	METHOD I

**VERIFICATION REQUIREMENT:**

Verify that accumulated times and/or cycles of time/cycle-critical items operated during testing do not exceed specified limits.

**DESCRIPTION OF REQUIREMENT:**

A logbook history showing all operational time/cycles and approximate time remaining on interface and/or safety critical equipment will be delivered with the designated hardware to the KSC launch site. KSC shall maintain and inspect logbooks to verify that limits have not been exceeded. This requirement will be placed in the OMRSD in the GIRD for implementation through applicable KSC WAD.

**DATA REQUIRED:**

OMRSD Baseline.

EXAMPLE

**APPLICABLE DOCUMENTS AND NOTES:**

Time Critical (Limited Life) Items List Logbook  
GIRD, JA-609  
ATLAS Mission Drawing Tree

**RESPONSIBLE PERSON:** Lead ATLAS Fractures Engineer      **ORG:** TBE/PMIC  
(TECHNICAL RESPONSIBILITY)

**PHONE NO:** 726-5162

**DATA SUBMITTAL DATE:** See Table 3-1

MISSION ATLAS	VERIFICATION REQUIREMENTS DEFINITION SHEET	PAYLOAD ELEMENT IPL
REQUIREMENT NO. 2. 1. 1	REQUIREMENT TITLE INTEGRATED PAYLOAD ITEMS WEIGHT	METHOD A

**VERIFICATION REQUIREMENT:**

Verify the weight of the ATLAS integrated pallet and miscellaneous hardware (cabling, plumbing).

**DESCRIPTION OF REQUIREMENT:**

Analysis to be performed after receiving all the ATLAS integrated payload/MPE/MDE/experiment weight data. All nonflight items and/or missing flight items shall be accounted for. Analysis may utilize applicable data/documentation submitted for experiment and MPE verification plan. PDS 4.1.1.1 (Weight).

**DATA REQUIRED:**

ATLAS (Current Mission) Mass Properties Status Report.

**EXAMPLE**

**APPLICABLE DOCUMENTS AND NOTES:**

SLP/2104, SPAH  
ATLAS Mission Mass Properties Status Report  
JA-1035D, E, F, G, K, M  
JA-1143A

RESPONSIBLE PERSON: Lead ATLAS Mass Prop Engineer    ORG: TBE/PMIC  
(TECHNICAL RESPONSIBILITY)

PHONE NO: 726-5011                      DATA SUBMITTAL DATE: See Table 3-1

MISSION ATLAS	VERIFICATION REQUIREMENTS DEFINITION SHEET	PAYLOAD ELEMENT IPL
REQUIREMENT NO. 2.1.3	REQUIREMENT TITLE INTEGRATED PAYLOAD ITEMS CENTER OF GRAVITY	METHOD A

**VERIFICATION REQUIREMENT:**

Verify the center of gravity for the ATLAS integrated pallet and miscellaneous hardware (cabling, plumbing).

**DESCRIPTION OF REQUIREMENT:**

Analysis will be performed after receiving all experiment and MPE data submittals to account for the ATLAS integrated Payload/ MPE/MDE/experiment components. All nonflight items and/or missing flight items shall be accounted for. Analysis may utilize applicable data/documentation submitted for experiment and MPE verification plans, VRDS 4.1.1.2 (Center of Gravity).

**DATA REQUIRED:**

ATLAS (Current Mission) Mass Properties Status Report.

**EXAMPLE**

**APPLICABLE DOCUMENTS AND NOTES:**

SLP/2104, SPAH  
ATLAS Mission Mass Properties Status Report  
JA-1035D, E, F, G, K, M  
JA-1143A

RESPONSIBLE PERSON: Lead ATLAS Mass Prop Engineer      ORG: TBE/PMIC  
(TECHNICAL RESPONSIBILITY)

PHONE NO: 726-5011

DATA SUBMITTAL DATE: See Table 3-1

MISSION ATLAS	VERIFICATION REQUIREMENTS DEFINITION SHEET	PAYLOAD ELEMENT IPL
REQUIREMENT NO. 2. 3.11	REQUIREMENT TITLE PHYSICAL INTERFERENCE	METHOD A

**VERIFICATION REQUIREMENT:**

Verify that, during planned flight operations, no physical interference occurs.

**DESCRIPTION OF REQUIREMENT:**

Analysis of the ATLAS integrated payload configuration showing that no physical interference occurs between translating and rotating payload element equipment components and/or the payload carrier during normal on-orbit operations.

**DATA REQUIRED:**

Integrated Payload Verification Analysis Report.

(NOTE: These data are used to close out Payload Hazard Report, No. I-1.)

**EXAMPLE**

**APPLICABLE DOCUMENTS AND NOTES:**

SLP/2104, SPAH, App. B and B-1  
JA-418A  
IPRD, JA-620  
NSTS 1700.7B

IIA: JA-606D, E, F, G, K, and M  
ICD 2-19001  
MSFC-STD-1299  
Mission GIRD; JA-487

RESPONSIBLE PERSON: Lead ATLAS Design Engineer      ORG: TBE/PMIC  
(TECHNICAL RESPONSIBILITY)

PHONE NO: 726-2877

DATA SUBMITTAL DATE: See Table 3-1

MISSION ATLAS	VERIFICATION REQUIREMENTS DEFINITION SHEET	PAYLOAD ELEMENT IPL
REQUIREMENT NO. 2. 3.20	REQUIREMENT TITLE SAFETY-CRITICAL FASTENERS	METHOD A

**VERIFICATION REQUIREMENT:**

Verify that safety-critical fasteners have the required positive locking devices and torque values specified on the Assembly and Installation Drawings (A&I Drawings) and that the KSC implementing WADs correctly reflect drawing requirements.

**DESCRIPTION OF REQUIREMENT:**

Verify that all applicable safety-critical fasteners to be installed at KSC in the integrated payload have the appropriate locking devices (lockwires, cotter pins, etc.) and torque values specified in the Assembly and Installation Drawings. Prepare a table of those requirements for each mission for official transmission by NASAMSFC Payload Projects Office (PPO) to KSC and review KSC implementing WADs for proper interpretation of installation requirements.

**DATA REQUIRED:**

1. Table of Requirements (see above Description of Requirement).
2. Integrated Payload Verification Analysis Report (WAD evaluation(s)).

(NOTE: These data are used to close out Payload Hazard Report, No. G-5.)

EXAMPLE

**APPLICABLE DOCUMENTS AND NOTES:**

MSFC-STD-561  
ATLAS Mission Drawing Tree

RESPONSIBLE PERSON: Lead ATLAS Design Engineer      ORG: TBE/PMIC  
(TECHNICAL RESPONSIBILITY)

PHONE NO: 726-2877      DATA SUBMITTAL DATE: See Table 3-1



MISSION ATLAS	VERIFICATION REQUIREMENTS DEFINITION SHEET	PAYLOAD ELEMENT IPL
REQUIREMENT NO. 3. 1. 2	REQUIREMENT TITLE CONTINUITY OF INSTALLED HARNESSES	METHOD T

VERIFICATION REQUIREMENT:

Verify cable conductor continuity of installed MPE harnesses.

DESCRIPTION OF REQUIREMENT:

Tests shall be performed on the ATLAS integrated payload configuration to verify continuity of cable conductors. Interconnecting cables and harness assemblies shall be tested for point-to-point electrical continuity.

Integrated payload test requirements are documented in the OMRSD in the GIRD for implementation through applicable KSC WADs.

DATA REQUIRED:

OMRSD Baseline.

**EXAMPLE**

APPLICABLE DOCUMENTS AND NOTES:

SLP/2104, SPAH, App. A  
JA-061C

GIRD, JA-609

Cable Design Documentation MPE Cable Harness  
Assemblies, F6-41524

RESPONSIBLE PERSON: Lead ATLAS Electrical Engineer      ORG: TBE/PMIC  
(TECHNICAL RESPONSIBILITY)

PHONE NO: 726-5150      DATA SUBMITTAL DATE: See Table 3-1

MISSION ATLAS	VERIFICATION REQUIREMENTS DEFINITION SHEET	PAYLOAD ELEMENT IPL
REQUIREMENT NO. 3. 1. 5	REQUIREMENT TITLE ELECTRICAL ISOLATION	METHOD T

**VERIFICATION REQUIREMENT:**

Once connections are made to payload side, verify specified isolation between:

- ac high side and structure
- ac and dc high side
- ac neutral and structure
- dc high side and structure
- dc return lines and structure.

**DESCRIPTION OF REQUIREMENT:**

Tests shall be performed as documented in the OMRSD in the GIRL for implementation through applicable KSC WADs.

**DATA REQUIRED:**

OMRSD Baseline.

EXAMPLE

**APPLICABLE DOCUMENTS AND NOTES:**

MSFC-SPEC-521A, para. 3.3  
SLP/2104, SPAH, Main Vol., para. 7.7.2.2.2  
IIA: JA-606D, E, F, G, K, and M  
GIRD, JA-609

**RESPONSIBLE PERSON:** Lead ATLAS Electrical Engineer      **ORG:** TBE/PMIC  
(TECHNICAL RESPONSIBILITY)

**PHONE NO:** 726-5150      **DATA SUBMITTAL DATE:** See Table 3-1

MISSION ATLAS	VERIFICATION REQUIREMENTS DEFINITION SHEET	PAYLOAD ELEMENT IPL
REQUIREMENT NO. 3. 1. 6	REQUIREMENT TITLE MINIMUM VOLTAGE	METHOD A and T

**VERIFICATION REQUIREMENT:**

Verify the minimum voltage delivered to the ATLAS instruments under full load conditions (ac and dc).

**DESCRIPTION OF REQUIREMENT:**

1. Analysis of the ATLAS integrated payload configuration shall be performed to verify voltage drop of worst-cast conditions meets minimum voltage required based on mission timeline.
2. Testing shall be performed only to instruments with marginal resource operations situations which might cause instrument damage or dropout. Test, if necessary, will be documented in the OMRSD in the GIRD and implemented through applicable WADs.

**DATA REQUIRED:**

1. Integrated Payload Verification Analysis Report.
2. OMRSD Baseline.

EXAMPLE

**APPLICABLE DOCUMENTS AND NOTES:**

SLP/2104, SPAH, Main Vol., para. 4.3.2.1  
IPRD, JA-620  
Mission Timeline (FDD)  
GIRD, JA-609

**RESPONSIBLE PERSON:** Lead ATLAS Electrical Engineer      **ORG:** TBE/PMIC  
(TECHNICAL RESPONSIBILITY)

**PHONE NO:** 726-5150

**DATA SUBMITTAL DATE:** See Table 3-1

MISSION ATLAS	VERIFICATION REQUIREMENTS DEFINITION SHEET	PAYLOAD ELEMENT IPL
REQUIREMENT NO. 3. 2. 1	REQUIREMENT TITLE PHASE-TO-PHASE LOAD BALANCE	METHOD A and T

**VERIFICATION REQUIREMENT:**

Verify phase-to-phase load balance in payload ac power loads.

**DESCRIPTION OF REQUIREMENT:**

1. By integrated analysis, confirm that the power factor and phase-to-phase load balance verified in response to JA-1035G (ATMOS), VRDS 4.2.1.8 (ac Phase Load Balance and Power Factor), remain valid in the integrated payload configuration.
2. Verification testing shall be performed in addition to the analysis if required to substantiate and/or complete the proof of compliance to specifications. Data/documentation submitted for JA-1035G (ATMOS), VRDS 4.2.1.8, may be used in the analysis and to test specifications. Testing requirements will be documented in the OMRSD in the CRP for implementation by KSC WADs.

**DATA REQUIRED:**

1. Integrated Payload Verification Analysis Report
2. OMRSD Baseline

EXAMINED

**APPLICABLE DOCUMENTS AND NOTES:**

SLP/2104, SPAH, App. A, para. 3.1.3.2  
GIRD, JA-609  
JA-1143A  
JA-1035G

**RESPONSIBLE PERSON:** Lead ATLAS Electrical Engineer      **ORG:** TBE/PMIC  
(TECHNICAL RESPONSIBILITY)

**PHONE NO:** 726-5150      **DATA SUBMITTAL DATE:** See Table 3-1

MISSION ATLAS	VERIFICATION REQUIREMENTS DEFINITION SHEET	PAYLOAD ELEMENT IPL
REQUIREMENT NO. 3. 2. 2	REQUIREMENT TITLE POWER DRAW	METHOD A and T

**VERIFICATION REQUIREMENT:**

Verify that power draw of the ATLAS integrated payload does not exceed levels specified in power profiles:

- Main dc power
- Experiment essential power
- 400-Hz ac power.

**DESCRIPTION OF REQUIREMENT:**

1. By analysis of the ATLAS integrated payload configuration verify that the composite power draw does not exceed specified power profiles. Verification shall address all equipment modes (Functional Objectives) based on mission timelines and the most power demanding combination of equipment modes.
2. Verification testing, addressing all equipment modes in the analysis, shall also be done to confirm that the power draw does not exceed the specified power profiles. Data/documentation submitted for experiment and MPE verification plans, VRDS 4.3.1.7 (Power Draw), may be used in the analysis and in the test specifications. Testing requirements will be documented in the OMRSD in the GIRD for implementation by KSC WADs (include Requirement 1.5.3, "Mission Sequence Tests").

**DATA REQUIRED:**

1. Integrated Payload Verification Analysis Report.

**APPLICABLE DOCUMENTS AND NOTES:**

SLP/2104, SPAH, Main Vol., para. 4.3.2.1.  
Mission Timeline (FDD)  
IIA: JA-606D, E, F, G, K, and M  
GIRD, JA-609

JA-1143A  
JA-1035D, E, F, G, K, M  
IPRD, JA-620

RESPONSIBLE PERSON: Lead ATLAS Electrical Engineer      ORG: TBE/PMIC  
(TECHNICAL RESPONSIBILITY)

PHONE NO: 726-5150

DATA SUBMITTAL DATE: See Table 3-1

MISSION ATLAS	VERIFICATION REQUIREMENTS DEFINITION SHEET	PAYLOAD ELEMENT IPL
REQUIREMENT NO. 3. 2. 3	REQUIREMENT TITLE EXPERIMENT POWER DISTRIBUTION	METHOD T

**VERIFICATION REQUIREMENT:**

Verify the ac and dc power interface (level and polarity) to the MPE/Instrument loads.

**DESCRIPTION OF REQUIREMENT:**

Tests shall be performed to verify that power inputs (voltage and polarity) to MPE/Instruments are in accordance with interface design prior to connection to MPE/Instrument hardware. Test requirements will be documented in the OMRSD in the GIRD for implementation by applicable KSC WADs.

**DATA REQUIRED:**

OMRSD Baseline.

**EXAMPLE**

**APPLICABLE DOCUMENTS AND NOTES:**

SLP/2104, SPAH  
GIRD, JA-609

**RESPONSIBLE PERSON:** Lead ATLAS Electrical Engineer      **ORG:** TBE/PMIC  
(TECHNICAL RESPONSIBILITY)

**PHONE NO:** 726-5150

**DATA SUBMITTAL DATE:** See Table 3-1

MISSION ATLAS	VERIFICATION REQUIREMENTS DEFINITION SHEET	PAYLOAD ELEMENT IPL
REQUIREMENT NO. 4.2	REQUIREMENT TITLE POCC PAYLOAD COMMAND CAPABILITY	METHOD T

**VERIFICATION REQUIREMENT:**

Verify capability to command ATLAS payload equipment from the Payload Operations Control Center (POCC) using the total system.

**DESCRIPTION OF REQUIREMENT:**

During Level I end-to-end tests, closed loop tests, or mission simulation tests, all POCC commands will be transmitted to the payload equipment and verified as being properly received by measurements or experiment status checks. Test requirements will be documented in the OMRSD in the GIRD and implemented by KSC through applicable WADs.

**DATA REQUIRED:**

OMRSD Baseline.

**EXAMPLE**

**APPLICABLE DOCUMENTS AND NOTES:**

GIRD, JA-609

RESPONSIBLE PERSON: Lead ATLAS CDMS Engineer      ORG: TBE/PMIC  
(TECHNICAL RESPONSIBILITY)

PHONE NO: 726-5150

DATA SUBMITTAL DATE: See Table 3-1

MISSION ATLAS	VERIFICATION REQUIREMENTS DEFINITION SHEET	PAYLOAD ELEMENT IPL
REQUIREMENT NO. 4.3	REQUIREMENT TITLE PAYLOAD TO POCC HIGH DATA RATE CAPABILITY	METHOD T

**VERIFICATION REQUIREMENT:**

Verify the capability to transmit high-rate digital data, video data, and analog data to the POCC and SLDPF from the ATLAS payload equipment.

**DESCRIPTION OF REQUIREMENT:**

Portions of the timeline containing the highest density of:

- a) Analog
- b) Digital
- c) Video
- d) Analog, digital, and video

Data will be transmitted to the POCC during mission sequence test. A high-density tape (HDT) using ATLAS HRM data will be developed by KSC and supplied to MSFC. The POCC received data will be compared to the ATLAS payload equipment HRM output for verification of fidelity of transmission. Test requirements will be documented in the OMRSD and the GIRD for implementation by applicable KSC WADs.

**DATA REQUIRED:**

OMRSD Baseline.

EXAMINABLE

**APPLICABLE DOCUMENTS AND NOTES:**

GIRD, JA-609

RESPONSIBLE PERSON: Lead ATLAS CDMS & POCC      ORG: TBE/PMIC  
(TECHNICAL RESPONSIBILITY)

PHONE NO: 726-5150      DATA SUBMITTAL DATE: See Table 3-1



MISSION ATLAS	VERIFICATION REQUIREMENTS DEFINITION SHEET	PAYLOAD ELEMENT IPL
REQUIREMENT NO. 5. 2. 1	REQUIREMENT TITLE PAYLOAD-PROVIDED COOLING LOOPCOOLANT	METHOD I

VERIFICATION REQUIREMENT:

Verify that ATLAS payload-provided coolant loops have been purged and filled with specified coolant and additives.

DESCRIPTION OF REQUIREMENT:

Inspection will be performed on the ATLAS integrated payload to verify that coolant loops have been purged and filled as specified. Inspection requirements shall be documented in the OMRSD in the GIRD for implementation through applicable KSC WADs.

DATA REQUIRED:

OMRSD Baseline.

**EXAMPLE**

APPLICABLE DOCUMENTS AND NOTES:

SLP/2104, SPAH, App. C  
GIRD, JA-609  
JA-1143A

RESPONSIBLE PERSON: Lead ATLAS Thermal Engineer      ORG: TBE/PMIC  
(TECHNICAL RESPONSIBILITY)

PHONE NO: 726-5364

DATA SUBMITTAL DATE: See Table 3-1

MISSION ATLAS	VERIFICATION REQUIREMENTS DEFINITION SHEET	PAYLOAD ELEMENT IPL
REQUIREMENT NO. 5. 2. 2	REQUIREMENT TITLE PAYLOAD-PROVIDED COOLING LOOPCOOLANT LOOP LEAKS	METHOD T

**VERIFICATION REQUIREMENT:**

Verify that payload-provided coolant loop components do not leak at joints or interfaces in excess of allowable limits at maximum operating pressure.

**DESCRIPTION OF REQUIREMENT:**

Leak tests at the ATLAS integrated payload level shall be performed to verify that the payload-provided coolant loop components do not leak at joints or interfaces in excess of allowable limits at the maximum operating pressure. Test requirements shall be documented in the OMRSD in the for GIRD for implementation by applicable KSC WADs.

NOTE: These data are used to close out Payload Hazard Report, No. MPE-2.

**DATA REQUIRED:**

OMRSD Baseline

EXAMPLE

**APPLICABLE DOCUMENTS AND NOTES:**

SLP/2104, SPAH, App. B-1, para. 4.3.3.3  
GIRD, JA-609

RESPONSIBLE PERSON: Lead ATLAS Thermal Engineer      ORG: TBE/PMIC  
(TECHNICAL RESPONSIBILITY)

PHONE NO: 726-5364      DATA SUBMITTAL DATE: See Table 3-1

MISSION ATLAS	VERIFICATION REQUIREMENTS DEFINITION SHEET	PAYLOAD ELEMENT IPL
REQUIREMENT NO. 5.3.4	REQUIREMENT TITLE EXPERIMENT EQUIPMENT, MPE, and MDE LOSS OF COOLING	METHOD A

**VERIFICATION REQUIREMENT:**

Verify a fail-safe condition in the event of loss of cooling to equipment.

**DESCRIPTION OF REQUIREMENT:**

The intent of this requirement is to verify that safety is not compromised in the event of failure of the cooling system. An ATLAS integrated payload analysis shall be made to verify that loss of cooling will not result in overtemperature, overpressure, fire, explosion, release of hazardous or toxic materials, or damage that could propagate to other systems. Data/documentation submitted for experiment and MPE verification plans, VRDS 4.4.9 (Loss of Cooling), may be used as inputs to the overall EES analysis.

**DATA REQUIRED:**

Integrated Payload Verification Analysis Report.

**EXAMPLE**

**APPLICABLE DOCUMENTS AND NOTES:**

NSTS 1700.7B  
JA-1143A  
JA-1035D, E, F, G, K, M

RESPONSIBLE PERSON: Lead ATLAS Thermal Engineer      ORG: TBE/PMC  
(TECHNICAL RESPONSIBILITY)

PHONE NO: 726-5364      DATA SUBMITTAL DATE: See Table 3-1

MISSION ATLAS	VERIFICATION REQUIREMENTS DEFINITION SHEET	PAYLOAD ELEMENT IPL
REQUIREMENT NO. 5.3.5	REQUIREMENT TITLE EXPERIMENT EQUIPMENT, MPE, and MDE EXPOSED SURFACES	METHOD A

**VERIFICATION REQUIREMENT:**

Verify that the temperature of all exposed equipment surfaces during prelaunch and postflight operations are greater than the maximum ambient dewpoint.

**DESCRIPTION OF REQUIREMENT:**

Perform ATLAS integrated payload analysis of all surfaces of equipment, whether exposed to the crew or not, whose operation could result in decreasing temperature or that employs active cooling, to verify that it remains above the dewpoint throughout ground operations (prelaunch and postflight). Data/documentation submitted for experiment and MPE verification plans, VRDS 4.12 [Equipment Dewpoint (Ground)], may be used in the analysis.

**DATA REQUIRED:**

Integrated Payload Verification Analysis Report.

EXAMPLE

**APPLICABLE DOCUMENTS AND NOTES:**

SLP/2104, SPAH, para. 5.2  
JA-1143A  
JA-609  
JA-1035D, E, F

RESPONSIBLE PERSON: Lead ATLAS Thermal Engineer      ORG: TBE/PMIC  
(TECHNICAL RESPONSIBILITY)

PHONE NO: 726-5364

DATA SUBMITTAL DATE: See Table 3-1

MISSION ATLAS	VERIFICATION REQUIREMENTS DEFINITION SHEET	PAYLOAD ELEMENT IPL
REQUIREMENT NO. 5. 4. 1	REQUIREMENT TITLE SPACELAB FREON COOLING LOOP TOTAL PRESSURE DROP	METHOD A and T

**VERIFICATION REQUIREMENT:**

Verify that the total pressure drop for the ATLAS Freon cooling loop for the specified coolant flowrate is compatible with system capability.

**DESCRIPTION OF REQUIREMENT:**

1. An ATLAS integrated payload fluid loop pressure drop analysis will be performed on the Spacelab freon coolant loop to verify that the total pressure drop is within system capability.
2. Tests shall be performed upon the ATLAS integrated payload configuration to verify that the total pressure drop for the freon loop is compatible with the system capability. Test requirements will be documented in the OMRSD in the GIRD for implementation by KS/WADs.

**DATA REQUIRED:**

1. Integrated Payload Verification Analysis Report.
2. OMRSD Baseline.

EXAMINABLE

**APPLICABLE DOCUMENTS AND NOTES:**

Payload Bay Mechanical MPE Assemblies CEI Spec  
B1-6-0121-TBE-A  
GIRD, JA-609

**RESPONSIBLE PERSON:** Lead ATLAS Thermal Engineer      **ORG:** TBE/PMIC  
(TECHNICAL RESPONSIBILITY)

**PHONE NO:** 726-5364

**DATA SUBMITTAL DATE:** See Table 3-1

MISSION ATLAS	VERIFICATION REQUIREMENTS DEFINITION SHEET	PAYLOAD ELEMENT IPL
REQUIREMENT NO. 5. 4. 2	REQUIREMENT TITLE SPACELAB FREON COOLING LOOP MAXIMUM SYSTEM PRESSURE	METHOD A

**VERIFICATION REQUIREMENT:**

Verify that the maximum system pressure of the ATLAS Freon cooling loop is compatible with component capability.

**DESCRIPTION OF REQUIREMENT:**

Perform an ATLAS integrated payload analysis to verify that the maximum system pressure in the Freon loop is within the capability of the components.

**DATA REQUIRED:**

Integrated Payload Verification Analysis Report.

**EXAMPLE**

**APPLICABLE DOCUMENTS AND NOTES:**

SLP/2104, SPAH, App. C, Table 5.3-1  
Payload Bay Mechanical MPE Assemblies CEI Spec  
B1-6-0121-TBE-A

**RESPONSIBLE PERSON:** Lead ATLAS Thermal Engineer      **ORG:** TBE/PMIC  
(TECHNICAL RESPONSIBILITY)

**PHONE NO:** 726-5364

**DATA SUBMITTAL DATE:** See Table 3-1

MISSION ATLAS	VERIFICATION REQUIREMENTS DEFINITION SHEET	PAYLOAD ELEMENT IPL
REQUIREMENT NO. 5. 4. 3	REQUIREMENT TITLE SPACELAB FREON COOLING LOOP SYSTEM VOLUME	METHOD A

**VERIFICATION REQUIREMENT:**

Verify that the ATLAS Freon cooling loop fluid system volume contraction and expansion and leakage are compatible with accumulator capability.

**DESCRIPTION OF REQUIREMENT:**

Perform an ATLAS integrated payload analysis of the Freon cooling loop verifying that possible fluid system volume expansion, contraction, and leakage is within the capabilities of the cooling loop accumulator throughout the mission. Data/documentation from the Payload Compatibility Analysis, IR-23 (Thermal), may be used in the analysis.

**DATA REQUIRED:**

Integrated Payload Verification Analysis Report.

EXAMPLE

**APPLICABLE DOCUMENTS AND NOTES:**

SLP/2104, SPAH, App. C  
JSC-16744  
IR-23 (Current Mission)

RESPONSIBLE PERSON: Lead ATLAS Thermal Engineer      ORG: TBE/PMIC  
(TECHNICAL RESPONSIBILITY)

PHONE NO: 726-5364

DATA SUBMITTAL DATE: See Table 3-1

MISSION ATLAS	VERIFICATION REQUIREMENTS DEFINITION SHEET	PAYLOAD ELEMENT IPL
REQUIREMENT NO. 5. 4. 4	REQUIREMENT TITLE SPACELAB FREON COOLING LOOP FREON LOOP TEMPERATURE	METHOD A

**VERIFICATION REQUIREMENT:**

Verify that the ATLAS Freon cooling loop temperatures for all mission phases are compatible with Freon loop operating limits and with component temperature limits based on the mission timeline.

**DESCRIPTION OF REQUIREMENT:**

Integrated payload analysis verifying that the ATLAS Freon loop temperatures remain within the loop component design specifications throughout all operational phases of the mission timeline.

**DATA REQUIRED:**

Integrated Payload Verification Analysis Report.

**EXAMPLE**

**APPLICABLE DOCUMENTS AND NOTES:**

SLP/2104, SPAH, App. C  
Payload Bay Mechanical MPE Assemblies CEI Spec  
B1-6-0121-TBE-A  
IR-23 (Current Mission)

RESPONSIBLE PERSON: Lead ATLAS Thermal Engineer      ORG: TBE/PMIC  
(TECHNICAL RESPONSIBILITY)

PHONE NO: 726-5364

DATA SUBMITTAL DATE: See Table 3-1



MISSION ATLAS	VERIFICATION REQUIREMENTS DEFINITION SHEET	PAYLOAD ELEMENT IPL
REQUIREMENT NO. 5.10. 1	REQUIREMENT TITLE SPACELAB/MPE ABSOLUTE TEMPERATURES AND TEMPERATURE	METHOD A

**VERIFICATION REQUIREMENT:**

Verify that ATLAS pallet and MPE absolute temperature and temperature gradient limits are not exceeded for any mission phase.

**DESCRIPTION OF REQUIREMENT:**

Integrated payload analysis, as driven by the mission timeline, verifying that the temperature and/or temperature gradients of ATLAS pallet and MPE remain within specifications throughout all mission phases. Data/documentation from the Payload Compatibility Analysis, IR-23 (Thermal), may be used, if appropriate, in the analysis.

**DATA REQUIRED:**

Integrated Payload Verification Analysis Report.

Note: These data are used to close out Payload Hazard Report No. G-5.

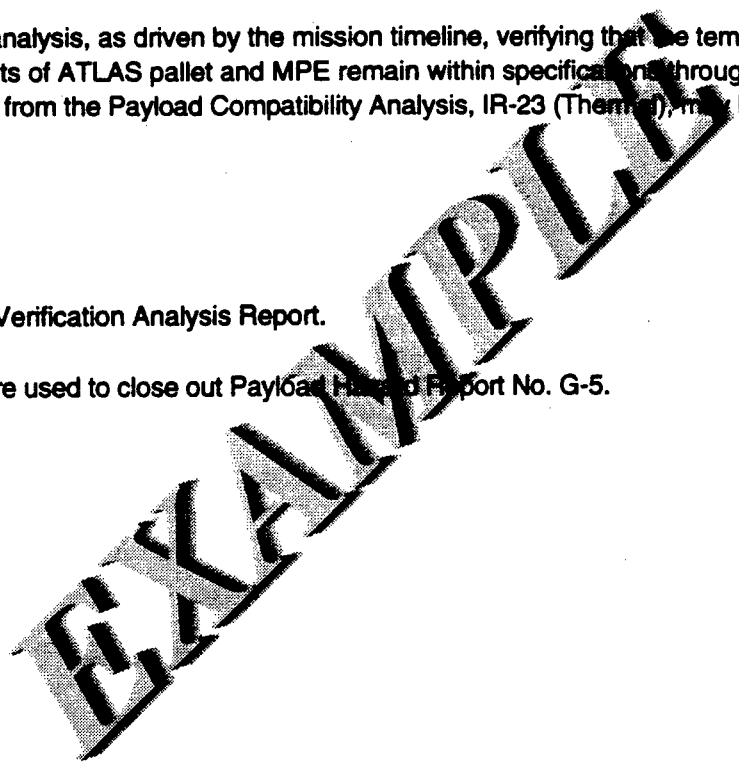

**APPLICABLE DOCUMENTS AND NOTES:**

- IPRD, JA-620
- SLP/2104, SPAH, App. C
- IR-23 (Current Mission)

RESPONSIBLE PERSON: Lead ATLAS Thermal Engineer      ORG: TBE/PMIC  
(TECHNICAL RESPONSIBILITY)

PHONE NO: 726-5364      DATA SUBMITTAL DATE: See Table 3-1

MISSION ATLAS	VERIFICATION REQUIREMENTS DEFINITION SHEET	PAYLOAD ELEMENT IPL
REQUIREMENT NO. 6. 1	REQUIREMENT TITLE ALIGNMENT TARGETS	METHOD T

**VERIFICATION REQUIREMENT:**

Verify proper installation and alignment of targets that establish the ATLAS reference system for payload equipment.

**DESCRIPTION OF REQUIREMENT:**

This requirement applies to the ATLAS MPE pallet support structure. Tests will be performed on the integrated payload configuration to verify proper installation of alignment targets. All nonflight targets must be removed before flight. Verification test requirements will be documented in the OMRSD in the GIRD for implementation by KSC WAD.

**DATA REQUIRED:**

OMRSD Baseline.

**EXAMPLE**

**APPLICABLE DOCUMENTS AND NOTES:**

GIRD, JA-609  
ATLAS Mission Payload Alignment Plan

RESPONSIBLE PERSON: Lead ATLAS Point&Align      ORG: TBE/PMIC  
(TECHNICAL RESPONSIBILITY)

PHONE NO: 726-5515      DATA SUBMITTAL DATE: See Table 3-1

MISSION ATLAS	VERIFICATION REQUIREMENTS DEFINITION SHEET	PAYLOAD ELEMENT IPL
REQUIREMENT NO. 6.2.1	REQUIREMENT TITLE MPE/MDE MECHANICAL ALIGNMENT	METHOD T

**VERIFICATION REQUIREMENT:**

Verify that mechanical alignment and coalignment of integrated MPE/MDE are adjusted to specifications.

**DESCRIPTION OF REQUIREMENT:**

Tests will be performed on the ATLAS integrated payload configuration to verify that the MDE/MPE has been aligned to the specifications. Verification test requirements and specifications will be documented in the OMRSD in the GIRD for implementation by KSC WAD.

**DATA REQUIRED:**

OMRSD Baseline.

**EXAMPLE**

**APPLICABLE DOCUMENTS AND NOTES:**

SLP/2104, SPAH, App. B  
GIRD, JA-609  
ATLAS Mission Payload Alignment Plan

RESPONSIBLE PERSON: Lead ATLAS Design Engineer      ORG: TBE/PMIC  
(TECHNICAL RESPONSIBILITY)

PHONE NO: 726-2877

DATA SUBMITTAL DATE: See Table 3-1

MISSION ATLAS	VERIFICATION REQUIREMENTS DEFINITION SHEET	PAYLOAD ELEMENT IPL
REQUIREMENT NO. 6.3.1	REQUIREMENT TITLE INSTRUMENT MECHANICAL ALIGNMENT	METHOD T

**VERIFICATION REQUIREMENT:**

Verify that mechanical alignment and coalignment of integrated instruments of pointing experiments are adjusted to specifications.

**DESCRIPTION OF REQUIREMENT:**

Tests will be performed upon the ATLAS integrated payload configuration verifying that alignment and coalignment of the integrated instruments conform to specified design requirements. The specifications and test verification requirements will be documented in the OMRSD in the GIRD for implementation by KSC WAD. Data/documentation submitted for JA-1035E (SUSIM), VPOSs 4.1.2.1 (Surface Alignment and Finish) and 4.1.2.20 (Optical Alignment), may be used in determining the test verification requirements, if appropriate.

**DATA REQUIRED:**

OMRSD Baseline.

EXAMPLE

**APPLICABLE DOCUMENTS AND NOTES:**

GIRD, JA-609  
IPRD, JA-620  
ATLAS Mission Drawing Tree  
JA-1035E

IIA's, JA-606, D, E, F, G, K, and M

RESPONSIBLE PERSON: Lead ATLAS Point&Align      ORG: TBE/PMIC  
(TECHNICAL RESPONSIBILITY)

PHONE NO: 726-5515      DATA SUBMITTAL DATE: See Table 3-1

MISSION ATLAS	VERIFICATION REQUIREMENTS DEFINITION SHEET	PAYLOAD ELEMENT IPL
REQUIREMENT NO. 6. 3. 2	REQUIREMENT TITLE INSTRUMENT POSITION	METHOD T

**VERIFICATION REQUIREMENT:**

Determine the position of pointing experiment instruments relative to the pallet reference system.

**DESCRIPTION OF REQUIREMENT:**

Tests will be performed on the ATLAS integrated payload configuration verifying that the position/alignment of the instruments relative to the pallet reference system conforms to design requirements. Design specifications and verification test requirements will be documented in the OMRSD in the GIRD for implementation by KSC WAD.

**DATA REQUIRED:**

OMRSD Baseline.

**EXAMPLE**

**APPLICABLE DOCUMENTS AND NOTES:**

- GIRD, JA-609
- IPRD, JA-620
- IAs, JA-606, D, E, F, G, K, and M
- ATLAS Mission Payload Alignment Plan

RESPONSIBLE PERSON: Lead ATLAS Point&Align      ORG: TBE/PMIC  
(TECHNICAL RESPONSIBILITY)

PHONE NO: 726-5515      DATA SUBMITTAL DATE: See Table 3-1

MISSION ATLAS	VERIFICATION REQUIREMENTS DEFINITION SHEET	PAYLOAD ELEMENT IPL
REQUIREMENT NO. 7.7	REQUIREMENT TITLE EMERGENCY SHUTDOWN / STOWING / SAFING / JETTISON	METHOD A

**VERIFICATION REQUIREMENT:**

Verify emergency shutdown, stowing, safing, and jettison functions.

**DESCRIPTION OF REQUIREMENT:**

Verify by analysis that ATLAS integrated payload configuration, shutdown, stowing, safing, and jettison functions can be accomplished efficiently, quickly, and safely in accordance with specified time/performance in an emergency situation.

**DATA REQUIRED:**

Integrated Payload Verification Analysis Report.

(NOTE: These data are used to close out Payload Hazard Report, No. G-5.)

**EXAMPLE**

**APPLICABLE DOCUMENTS AND NOTES:**

Payload Crew Emergency Procedures  
Payload Flight Data File

RESPONSIBLE PERSON: Lead ATLAS Safety Engineer      ORG: TBE/PMIC  
(TECHNICAL RESPONSIBILITY)

PHONE NO: 726-5255      DATA SUBMITTAL DATE: See Table 3-1

MISSION ATLAS	VERIFICATION REQUIREMENTS DEFINITION SHEET	PAYLOAD ELEMENT IPL
REQUIREMENT NO. 9.2.1.2	REQUIREMENT TITLE ASSIGNED CHANNEL OUTPUTS	METHOD T

**VERIFICATION REQUIREMENT:**

Validate output operations on assigned channels.

**DESCRIPTION OF REQUIREMENT:**

The data channels should be activated individually to validate the assignments and should be activated in sequence to determine if proper multiplexing occurs. Data from these tests will be used to determine co-channel interference and proper channel assignment. Test requirements will be placed in the OMRSD in the GIRD for implementation by applicable KSC WADs.

**DATA REQUIRED:**

1. Flight Data Tape.
2. OMRSD Baseline

EXAMPLE

**APPLICABLE DOCUMENTS AND NOTES:**

IPRD, JA-620  
O&IA: JA-607D, E, F, G, K, and M  
SLP/2104, SPAH, para. 4.4 and App. A, sec. 4  
GIRD, JA-609

RESPONSIBLE PERSON: Lead ATLAS CDMS Engineer      ORG: TBE/PMIC  
(TECHNICAL RESPONSIBILITY)

PHONE NO: 726-5150

DATA SUBMITTAL DATE: See Table 3-1

MISSION ATLAS	VERIFICATION REQUIREMENTS DEFINITION SHEET	PAYLOAD ELEMENT IPL
REQUIREMENT NO. 9. 2. 1. 3	REQUIREMENT TITLE ASSIGNED CHANNEL INPUTS	METHOD T

**VERIFICATION REQUIREMENT:**

Validate input operations on assigned channels.

**DESCRIPTION OF REQUIREMENT:**

The data channels should be activated individually to validate the assignments and should be activated in sequence to determine if proper multiplexing occurs. Data from these tests will be used to determine co-channel interference and proper channel assignment. Test requirements will be placed in the OMRSD in the GIRD for implementation by applicable KSC WADs.

**DATA REQUIRED:**

1. Flight Data Tape.
2. OMRSD Baseline

EXAMPLE

**APPLICABLE DOCUMENTS AND NOTES:**

IPRD, JA-620  
IIA: JA-606D, E, F, G, K, and M  
O&IA: JA-607D, E, F, G, K, and M  
GIRD, JA-609

**RESPONSIBLE PERSON:** Lead ATLAS CDMS Engineer      **ORG:** TBE/PMIC  
(TECHNICAL RESPONSIBILITY)

**PHONE NO:** 726-5150      **DATA SUBMITTAL DATE:** See Table 3-1



MISSION ATLAS	VERIFICATION REQUIREMENTS DEFINITION SHEET	PAYLOAD ELEMENT IPL
REQUIREMENT NO. 9. 2. 5. 2	REQUIREMENT TITLE KEYBOARD COMMANDS	METHOD T

VERIFICATION REQUIREMENT:

Validate proper receipt of keyboard commands from single/multiple keyboards.

DESCRIPTION OF REQUIREMENT:

All keyboard commands must be exercised to their applicable end items (e.g., ECAS, DEP, etc.) to validate correctness of destination and data transfer. Test requirements will be placed in the OMRSD in the GIRD for implementation by KSC WAD.

DATA REQUIRED:

1. Flight Data Tape.
2. OMRSD Baseline.

**EXAMPLE**

APPLICABLE DOCUMENTS AND NOTES:

GIRD, JA-609

RESPONSIBLE PERSON: TRW ORG: TRW  
(TECHNICAL RESPONSIBILITY)

PHONE NO: 922-4624 DATA SUBMITTAL DATE: See Table 3-1







MISSION ATLAS	VERIFICATION REQUIREMENTS DEFINITION SHEET	PAYLOAD ELEMENT IPL
REQUIREMENT NO. 9. 2. 6. 3	REQUIREMENT TITLE OUTPUT DATA TRANSFER FROM MMU	METHOD T
<p>VERIFICATION REQUIREMENT:</p> <p>Validate output data transfer from mass memory unit (MMU).</p> <p>DESCRIPTION OF REQUIREMENT:</p> <p>Exercise data transfer from the MMU to all appropriate end items. Validate proper data transfer by data dump or other appropriate means. Test requirements will be placed in the OMRSD in the GIRD for implementation by KSC WAD.</p> <p>DATA REQUIRED:</p> <ol style="list-style-type: none"> <li>1. Flight Data Tape.</li> <li>2. OMRSD Baseline.</li> </ol> <p style="text-align: center; font-size: 2em; opacity: 0.5; transform: rotate(-15deg);">EXAMPLE</p> <p>APPLICABLE DOCUMENTS AND NOTES: GIRD, JA-609</p> <p>RESPONSIBLE PERSON: <u>TRW</u> _____ ORG: <u>TRW</u> _____ (TECHNICAL RESPONSIBILITY)</p> <p>PHONE NO: <u>922-4624</u> _____ DATA SUBMITTAL DATE: <u>See Table 3-1</u> _____</p>		

MISSION ATLAS	VERIFICATION REQUIREMENTS DEFINITION SHEET	PAYLOAD ELEMENT IPL
REQUIREMENT NO. 9. 2. 7. 1	REQUIREMENT TITLE ECIO DATA SYSTEM	METHOD T

**VERIFICATION REQUIREMENT:**

Validate the output rate (25.6 or 51.2 kbs), format, and contents of the experiment computer input/output (ECIO) data system.

**DESCRIPTION OF REQUIREMENT:**

The maximum data rates from all experiments would be input to the experiment computer to verify that the output rate of 25.6 or 51.2 kbs is not exceeded. The output rate can be verified by measurements from this functional test. Test requirements and the requirement that they be accomplished as a part of experiment functional or mission sequence tests will be placed in the OMRSD in the GIRD for implementation by appropriate KSC WADs.

**DATA REQUIRED:**

1. Flight Data Tape.
2. OMRSD Baseline.

EXAMPLE

**APPLICABLE DOCUMENTS AND NOTES:**

POCC Data Base  
O&IA: JA-607D, E, F, G, K, and M  
GIRD, JA-609

RESPONSIBLE PERSON: Lead ATLAS CDMS and Ops      ORG: TBE/PMIC  
(TECHNICAL RESPONSIBILITY)

PHONE NO: 726-5150 & 726-5016      DATA SUBMITTAL DATE: See Table 3-1









**APPENDIX B**  
**ACRONYM AND ABBREVIATION LIST**

**EXAMPLE**

A	Analysis; Ampere
ac	Alternating Current
ADT	Analog Data Tape
AFD	Aft Flight Deck
AI	Analog Input
ATE	Automatic Test Equipment
BET	Best Estimate of Trajectory
bps	Bits Per Second
C	Celsius
CBR	Connector Bracket
CCTV	Closed-Circuit Television
CDMS	Command and Data Management System
CDT	Configuration Data Table
CEI	Contract End-Item
CG	Center of Gravity
CID	Cable Interconnect Diagram
CMD	Command
CMU	Current Monitor Unit
COC	Certificate of Compliance
CP	Coldplate; Control Panel
CPSS	Coldplate Support Structure
CPU	Central Processing Unit
DACH	Dedicated Access Channel
dc	Direct Current
DDS	Data Display System
DED	Dedicated
deg	Degree
DEP	Dedicated Experiment Processor
DPU	Digital Processing Unit
EC	Experiment Computer
EC/LS	Environmental Control/Life Support
ECAS	Experiment Computer Application System
ECE	Experiment Checkout Equipment
ECI/O	Experiment Computer Input/Output
ECOS	Experiment Computer Operating System
ECS	Environment Control Subsystem

EGSE	Experiment Ground Support Equipment
EMC	Electromagnetic Compatibility
EMI	Electromagnetic Interference
EMOD	Electronics Module
EPBD	Experiment Power Branching Distributor
EPDB	Experiment Power Distribution Box
EPDS	Experiment Power Distribution Subsystem
EPS	Experiment Power System
EPSP	Experiment Support Structure
ESRD	Experiment Software Requirements Document
EU	Engineering Unit
EXP	Experiment
FDR	Final Design Review
FEB	Filter Electronics Box
FOV	Field of View
FREQ	Frequency
FRR	Flight Readiness Review
ft	Foot
g	Acceleration of Gravity
g-Level	Gravitational Acceleration Level
GIRD	Ground Integration Requirements Document
grms	Acceleration Root Mean Square
GSE	Ground Support Equipment
GSFC	Godard Space Flight Center
h	Hour
HDBK	Handbook
HDRR	High Data Rate Recorder
HDRREU	High Data Rate Recorder Electronics Unit
HDRRTU	High Data Rate Recorder Transport Unit
HEX	Hexadecimal
HR	Hazard Report
HRM	High-Rate Multiplexer
HTR	Heater
HVC	High-Voltage Converter
HW	Hardware
Hz	Hertz

I	Inspection
I/F	Interface
I/O	Input/Output
IIA	Instrument Interface Agreement
IMCP	Integrated Monitor and Control Panel
in.	Inch
INV	Inverter
IPL	Integrated Payload
IPL CDR	Integrated Payload Critical Design Review
IPRD	Integrated Payload Requirements Document
IRR	Integration Readiness Review
JSC	Johnson Space Center
KB	Keyboard
Kb	Kilobit
kbps	Kilobits per Second
kg	Kilogram
km	Kilometer
KSC	Kennedy Space Center
KUSP	Ku-Band Signal Processor
kWh	Kilowatthour
lb	Pound
LCC	Launch Control Center
LOS	Line of Sight
LPS	Launch Processing System
LSSP	Launch Site Support Plan
LV	Local Vertical
m	Meter
MAX	Maximum
max	Maximum
Mbps	Megabits per Second
MDE	Mission-Dependent Equipment
MDM	Multiplexer/Demultiplexer
MET	Mission Elapsed Time
MHz	Megahertz
MIL	Military
Min	Minimum

min	Minute
MM	Mission Manager
mo	Month
MPE	Mission-Peculiar Equipment
MROFIE	Mission Requirements on Facilities/Instruments/Experiments for Space Transportation System Attached Payloads
MS	Mission Specialist
MSDP	Mission Station Distribution Panel
MSFC	George C. Marshall Space Flight Center
MTU	Master Timing Unit
MUX	Multiplexer
N/A	Not Applicable
NA	Not Applicable
NASA	National Aeronautics and Space Administration
nmi	Nautical Mile
O&IA	Operations and Integration Agreement
OAFD	Orbiter Aft Flight Deck
OCT	Octave
OD	Operational Downlink
OFD	Orbiter Flight Data
OMI	Operations and Maintenance Plan
OMRSD	Operation and Maintenance Requirements Specification Document
OMS	Orbiter Maneuvering Subsystem
P/L	Payload
PCM	Pulse Code Modulation
PCMMU	PCM Master Unit
PDB	Payload Distribution Box
PED	Payload Element Developer
PEP	Payload Experiment Package
PIP	Payload Integration Plan
PLR	Payload Recorder
PMIC	Payload Missions Integration Contract
PMM	Payload Mission Manger
POCC	Payload Operations Control Center
PRCS	Primary Reaction Control System

PS	Payload Specialist
PTB	Payload Timing Buffer
PTS	Mission Payload Timeline Summary
PWR	Power
RAD	Radiometer
RAU	Remote Acquisition Unit
RCCB	Remote Control Circuit Breaker
RELBET	Relative Best Estimate Trajectory
RMS	Remote Manipulator System
RPC	Remote Power Controller
RT	Real Time
S	Second
s. mi.	Statute Mile
S/L	Spacelab
S/M	Structural/Mechanical
S/S	Subsystem; Samples/Second
SANC	Spacelab Ancillary
SC	Subsystem Computer
SCIO	Subsystem Computer Input/Output
SDF	Software Development Facility
sec	Second
SECT	Spacelab Experiment Compatible Tape
SI	Serial Input
SICT	Spacelab Input/Output Computer Compatible Tape
SIPS	Spacelab Input Processing System
SL	Spacelab
SLDPF	Spacelab Data Processing Facility
SO	Serial Output
SOPS	Spacelab Output Processing System
SPAH	Spacelab Payload Accommodation Handbook
SPMA	Spacelab Postmission Ancillary
STS	Space Transportation System
TAP	Test and Assembly Procedure
TBD	To Be Determined
TBE	Teledyne Brown Engineering
TBS	To Be Supplied

TCS	Thermal Control System
TSF	Television Support Facility
TU	Transport Unit
TV	Television
TYP	Typical
UCAT	User Calibrated Ancillary Tape
UCS	User Clock Signal
UCSU	User Clock Signal Update
VAS	Video/Analog Switch
VCR	Video Cassette Recorder
VRCS	Vernier Reaction Control System
VRDS	Verification Requirement Definition Sheet
VSN	Video Switching Network
VTR	Video Tape Recorder
VV	Velocity Vector
W	Watt
WAD	Work Authorization Document
WATTS	Wideband Analog Time Tagging System

**EXAMINED**



**APPENDIX C**

**IPL VERIFICATION/OMRSD REQUIREMENT  
MATRIX**

**EXAMPLE**

# IPL VERIFICATION/OMRSD MATRIX

IPL VERIFICATION REQUIREMENT NUMBER	REQUIREMENT TITLE		REQUIREMENT NUMBER
1.1.1	REVERIFICATION OF PLANNED SEPARATED INTERFACES	H218	GENC.010
1.1.2	REVERIFICATION OF UNPLANNED SEPARATED INTERFACES	H218	GENC.010
1.2	CERTIFICATION OF TEST EQUIPMENT AND GSE	H218	GENC.160
1.5.2	SURFACE CLEANLINES	H218	GENC.020
1.5.3	MISSION SEQUENCE TESTS	H218	IPLT.250, IPLT.110
1.6	NONFLIGHT EQUIPMENT REMOVAL	H218	IPLT.310, MAST.060, SCMT.060
1.7.2	EQUIPMENT FUNCTIONAL CHECKOUT	H218	ATMT .070, SCMT .030, SOLT .130, SUST .050, SCMT .020
1.9	TIME/CYCLE-CRITICAL COMPONENTS	H218	ATML .010
3.1.1	ISOLATION OF INSTALLED HARNESSSES	H218	MPET.090, GENC.130
3.1.2	CONTINUITY OF INSTALLED HARNESSSES	H218	MPET.080
3.1.5	ELECTRICAL ISOLATION	H218	GENC.130, GENT.250, MPET.120
3.1.6	MINIMUM VOLTAGE	H218	MPET .110
3.2.1	PHASE-TO-PHASE LOAD BALANCE	H218	ATMT.050, GENT.250
3.2.2	POWER DRAW	H218	IPLT .050
3.2.3	EXPERIMENT POWER DISTRIBUTION	H218	IPLT.040, MPET.070
3.2.4	EXPERIMENT POWER CONTROL	H218	IPLT.040, MPET.070
4.1	PAYLOAD COMMAND AND DATA LINKS	H218	ACRT.090, ACRT.060, ATMT .070, IPLT .060 IPLT.070, IPLT.080 IPLT.090, IPLT.100 IPLT.120, IPLT.240 IPLT.250 SOLT.140
4.2	POCC PAYLOAD COMMAND CAPABILITY	H218	IPLT .250
4.3	POCC HIGH-RATE DATA TO PAYLOAD	H218	IPLT.080
5.2.1	COOLANT	H218	IPLT.190, GENT.260
5.2.2	COOLANT LOOP LEAKS	H218	MPET.190
5.2.5	COOLING LOOP CONDENSATION		FILE VII; VOL I

2.5 - 81

# IPL VERIFICATION/OMRSD MATRIX

## IPL VERIFICATION REQUIREMENT NUMBER

## REQUIREMENT TITLE

## REQUIREMENT NUMBER

5.3.2	OPTICAL PROPERTIES	H218	GENC.190
5.4.1	TOTAL PRESSURE DROP		FILE VII; VOL I
6.1	ALIGNMENT TARGETS		FILE VII; VOL I
6.2.1	MECHANICAL ALIGNMENT		FILE VII; VOL I
6.3.2	INSTRUMENT POSITION	H218	ACRT.070
			MPET.030, MPET .170
			MPET.050, MAST.030
			SCMT.050, SOLT.160
			SUST.040
9.2.1.2	ASSIGNED CHANNEL OUTPUTS	H218	IPLT .250
9.2.1.3	ASSIGNED CHANNEL INPUTS	H218	IPLT.060, IPLT.250
9.2.5.2	KB COMMANDS	H218	IPLT .250
9.2.5.3	FUNCTION KEY INPUTS	H218	IPLT.250
9.2.5.4	DISPLAY ALLOCATION AND DISPLAY PAGE	H218	IPLT.250
9.2.6.2	INPUT DATA TRANSFER TO MMU	H218	IPLT.250
9.2.6.3	OUTPUT DATA TRANSFER FROM MMU	H218	IPLT.250
9.2.6.5	DEP LOAD OPERATIONS FROM MMU	H218	IPLT.250
9.2.7.1	ECIO DATA SYSTEM	H218	IPLT.250
9.2.11.1	EC SOFTWARE	H218	IPLT.250
9.3.1.1	EC SW WITH CPU	H218	IPLT.070, IPLT.250
9.3.2.1	EC MISSION SW CPU/IOU DATA TRANSFER	H218	IPLT.070, IPLT.250
9.3.3.1	DATA BUS OPERATION	H218	IPLT.070, IPLT.250

## **2.6**

# **OPERATIONS AND MAINTENANCE REQUIREMENTS AND SPECIFICATIONS DOCUMENT**

## 2.6.1 INTRODUCTION

File II, Volume II and File VII, Volume II of the Operations and Maintenance Requirements and Specifications Document (OMRSD) defines the requirements and specifications for processing experiments or an integrated payload at the launch site. These OMRSD files define all verification requirements, servicing requirements, hazardous operations, crew participation, and post-landing requirements for de-integration. For Spacelab programs, these OMRSD files are included as part of the Ground Integration Requirements Document. The example is a section of the OMRSD prepared by McDonnell Douglas Aerospace for the Spacelab Projects Office for the Spacelab-2 mission.

**2.6.2**

**OPERATIONS AND MAINTENANCE  
REQUIREMENTS AND SPECIFICATIONS  
DOCUMENT**

**EXAMPLE**

**THIS PAGE INTENTIONALLY LEFT BLANK**

**SPACE SHUTTLE  
OPERATIONS AND MAINTENANCE  
REQUIREMENTS AND SPECIFICATIONS  
DOCUMENT**

**FILE VII, VOL. II**

**PAYLOAD INTERFACES  
P034 - L03**

**EXAMPLE**



THIS PAGE INTENTIONALLY LEFT BLANK

**EXAMPLE**

FILE VII  
FILE INDEX

<u>FILE NAME</u>	<u>CHANGED</u>	<u>CONTENTS</u>
INDEX-SL	12-07-84	FILE VII - FILE INDEX
HISTLOG	11-15-84	FILE VII RCN HISTORICAL LOG
SL-INLOG	12-07-84	SE OMRS RCN INCORPORATION LOG
MDMINLOG	08-30-84	MDM/PALLET OMRS RCN INCORPORATION LOG

BASELINED MDM/PALLET FILESREQUIREMENTS

L00Z0	02-09-84	MDM/PALLET SYSTEM
L06Z0	01-27-84	PASSIVE THERMAL CONTROL SYSTEM
L63Z0	07-06-84	ACTIVE THERMAL CONTROL SYSTEM
L75Z0	04-19-84	C & DH REQUIREMENTS
L76Z0	06-11-84	ELECTRICAL POWER DISTRIBUTION SYSTEM
L81Z0	12-01-83	PALLET STRUCTURE

CONSTRAINTS

L00ZR	07-20-84	MDM/PALLET SYSTEM CONSTRAINTS
L63ZR	08-30-84	ACTIVE THERMAL CONTROL SYSTEM
L75ZR	07-06-84	C & DH CONSTRAINTS
L76ZR	12-01-83	ELECTRICAL POWER DISTRIBUTION SYSTEM CONSTRAINTS
L81ZR	12-02-83	PALLET STRUCTURE CONSTRAINTS

BASELINED SPACELAB OMRS FILES

REQUIREMENTS

L0000	10-31-84	SPACELAB SYSTEM
L0600	10-31-84	PASSIVE THERMAL CONTROL SYSTEM
L3300	10-31-84	MODULE STRUCTURE
L6000	12-06-84	ENVIRONMENTAL CONTROL SYSTEM
		L60A-C ASCS L60D EXP VENT ASSY L60E-F COOLING LOOP L60M,O AV COOLING LOOP L60N FSS
L6300	12-05-84	ACTIVE THERMAL CONTROL SYSTEM
		L63F FREON LOOP L63W WATER LOOP
L6500	12-06-84	CREW HABITABILITY
L7200	10-29-84	COMMAND AND DATA MANAGEMENT SYSTEM
L7300	10-30-84	SYSTEM ACTIVATION AND MONITORING, C&W
L7500	10-30-84	CCTV
L7600	10-30-84	ELECTRICAL POWER DISTRIBUTION SYSTEM
		L76 EXPERIMENT PWR SWITCHING PANEL L76A MONITOR AND CONTROL PANEL L76B EPDS INVERTER L76C POWER CONTROL BOX L76D ELEC PWR DIST BOX L76E EMERGENCY BOX L76F LIGHTING

2.6-8

07 DECEMBER 1984

L76G EPSP PWR SOURCE I/F  
L76H WORKBENCH RACK POWER OUTLET  
L76K S/S PWR DIST BOX

L7800	10-30-84	VFI
L8000	10-29-84	SPACELAB TRANSFER TUNNEL
L8100	10-29-84	PALLET STRUCTURE
L8200	10-30-84	IGLOO STRUCTURE
		PRIMARY STRUCTURE
		L82J PRV & BURST
		L82T HDRA TU BOX ASSEMBLY
L8300	12-07-84	COMMON PAYLOAD SUPPORT EQUIPMENT
		L83A SA
		L83S SWAA
		L83V VIEWPORTS ASSEMBLY
L8400	12-07-84	INSTRUMENT POINTING SYSTEM
L9000	12-06-84	SOFTWARE
		L90E ECOS
		L90S SCOS
LOP023	08-15-84	SL-2 INTEGRATED REQUIREMENTS
LOP034	09-10-84	SL-3 INTEGRATED REQUIREMENTS
LMA	10-25-84	PREVENTIVE MAINTENANCE-AGE SENSITIVE
LMC	12-06-84	PREVENTIVE MAINTENANCE-CYCLE SENSITIVE

2.6-9

07 DECEMBER 1984

CONSTRAINTS

L000R	10-03-83	SPACELAB SYSTEM
L330R	08-09-83	MODULE STRUCTURE
L600R	07-12-84	ENVIRONMENTAL CONTROL SYSTEM
L630R	12-06-84	ATES CONSTRAINTS
L650R	09-17-82	CREW HABITABILITY
L720R	10-25-84	COMMAND AND DATA MANAGEMENT SYSTEM
L750R	08-23-83	CCTV CONSTRAINTS
L760R	04-16-84	ELECTRICAL POWER DISTRIBUTION SYSTEM
L780R	01-25-84	VFI CONSTRAINTS
L800R	08-09-84	SPACELAB TRANSFER TUNNEL CONSTRAINTS
L810R	08-09-84	PALLET STRUCTURE
L830R	05-25-83	CPSE CONSTRAINTS

2.6 - 10

EXEMPLE

FILE VII RCN HISTORICAL LOG JANUARY 03,1985

RCN NO.	STS	STA	DATE SUBM	REVIEW MSFC	STATU S KSC	SHORT TITLE	DISP. BY	DATE DISP	DATE INCOR	DATE RMVD.	ARCH. DATE JULIAN
ML1246	21	A	10184	1102	C	L60L-AVION FAN DELTA PRESS UPDATE	3396	11304	12064	01025	84355
ML1226		A	10044	1018	C	L630R-THERMAL CAPACITOR STOR.	3996	11304	12064	01025	84356
ML1225	24	A	10254	1127	C	L84-EVA ACCESSIBILITY	3996	11304	12054	01025	84355
ML1219	21	A	10184	1106	C	L65P-VFY STOWAGE ITEM BATTS	3996	11304	12064	01025	84356
ML1218	24	A	10154	1106	C	L84-IPS CONT STOWAGE DEVICE	3996	11304	12054	01025	84356
ML1195M	21	A	10174	1017	CC	L72-BUC AUTO RESTART UPDATE	3887	10234	10234	11214	84325
ML1194	21	W				L76-VFY ISOL OF S/S & EXP AC BUSSES				10314	N/A
ML1191	17	A	08174	0825	C	L63ZR-QD ACTUATION CONSTRAINT	3750	08274	08304	10264	84297
ML1187M	61A	A	08284	0912	C	L00 HRM INPUT INTERFACE	3853	10034	10104	11214	84325
ML1184	21	A	08164	0827	C	L630R-QD ACTIVATION CONSTRAINT	3777	09064	09104	10264	84297
ML1183	21	W				L630R-NEON 114 QUALITY U/D				10314	N/A
ML1173	21	A	09074	0918	C	L00-NPRV CONF. POST LANDING	3853	10034	10104	11214	84325
ML1172A	21	A	09264	1009	C	L60J-CONDENSATE WEIGHT-POST FLT	3897	10234	10254	11264	84325
ML1164	21	A	08304	0912	C	L60-V FAN EFF UPDATE	3853	10034	10104	11214	84325
ML1163	61A	A	08284	0912	C	L53-GASKET SEAL LEAKAGE U/D	3853	10034	10104	11214	84325
ML1157A	24	A	09074	0924	C	L72-EXP DATA BMS TEST UPDATE	3853	10034	10094	11214	84325
ML1155M	61A	A	09114	0917	C	L75-COXY LEVEL II II GENERIC RQMTS	3853	10034	10094	11264	84325
ML1152	24	A	08304	0912	C	L72E-C&V MOD 2 ALARM EFF U/D	3853	10034	10094	11214	84325
ML1150		A	08244	0830	C	L630R-ATCS STANDBY/STORAGE CONSTR	3848	10014	10044	10264	84297
ML1140	24	A	09244	1009	C	L78-VFI EQUIP REMOVAL POSTFLIGHT	3897	10234	10254	11214	84325
ML1137	61A	A	08304	0912	C	L60-RELIEF VALVE UPDATE	3853	10034	10104	11214	84325
ML1136	61A	A	08304	0912	C	L80-STT EFFECTIVITY UPDATE	3853	10034	10104	11264	84325
ML1135	61A	A	08304	0912	C	L63-WATER LOOP EFF UPDATE	3853	10034	10094	11214	84325
ML1134M	61A	A	09184	0924	C	L83-VIEWPORT EFFECTIVITY UPDATE	3853	10034	10094	11214	84325
ML1133	24	A	08034	0813	C	L82-VFY HDRRA TU BOX FLT PREASURE	3750	08274	08304	10014	84264
ML1129	61A	A	08304	0912	C	L72-REMOTE CMD EFFECTIVITY UPDATE	3853	10034	10094	11214	84325
ML1128	61A	A	08304	0912	C	L72-COUPLER EFFECTIVITY UPDATE	3853	10034	10094	11264	84325
ML1127	21	W				L72-ICMS EFFECTIVITY UPDATE				10104	N/A
ML1126A	21	A	09184	1009	C	L72BR-HDRRA FAN DEACT CONST	3897	10234	10254	11214	84325
ML1124	61A	A	08304	0913	CC	L60-02/N2 PANEL UPDATE	3853	10034	10104	11214	84325
ML1123		W				L76-VERIFY LUMINARY 4 FUNCTION				07184	N/A
ML1122	61A	A	09134	0927	C	L60-DI UNIQUE VENT ASSY LEAK	3897	10234	10254	11214	84325
ML1121M	21	A	09064	0918	C	L72-RAU PWR OFF UPDATE	3853	10034	10094	11264	N/A
ML1121M	21	A	09064	0918	C	L72-RAU PWR OFF UPDATE	3853	10034	10094	11264	84325
ML1120	61A	A	08094	0827	C	L72M-UPDATE INTERCOM RQMTS EFF.	3848	10014	10044	10264	84297
ML1119	61A	A	08094	0827	C	L73N-UPDATE SAM RQMTS EFF	3848	10014	10054	10264	84297
ML1118	61A	A	07264	0808	C	L76-UPDATE OVERHEAD LUMINARY EFF	3729	08174	08234	10014	84264
ML1117	61A	A	07264	0827	C	L76-UPDATE INV RQMTS EFF	3848	10014	10044	10264	84297
ML1116	61A	A	07264	0816	C	L76-UPDATE EPDS REQUIREMENTS EFF	3750	08274	08304	10014	84264
ML1114		A	08174	0830	C	L63W-REVERT WATER GND CHG TO SL-I	3884	10174	10184	11214	84325
ML1111	21	A	08304	0912	C	L63WR-WATER PUMP INLET PRESS CONSTR	3853	10034	10094	11214	84325

26-11

MSFC-HDBK-2221  
February 1994

FILE VII RCN HISTORICAL LOG JANUARY 03,1985

RCN NO.	STS	STA	DATE SUBM	REVIEW MSFC	STATU S KSC	SHORT TITLE	DISP. BY	DATE DISP	DATE INCOR	DATE RMVD.	ARCH. DATE JULIAN
ML1109A	61A	A	08304	0912	C	L60-EFFECTIVITY UPDATE	3853	10034	10094	11214	84325
ML1108M	21	A	10024	1009	C	L60N-SUBFLR PURGE & HALON LK CK	3885	10244	10244	11264	84325
ML1107	21	A	08094	0827	C	L630R-WPP/FPP BYPASS VALVE CONSTR	3848	10014	10044	10264	84297
ML1106	21	D		0828		L60L-AVIONICS FAN PERFORMANCE	3779	09064		10014	84264
ML1102	21	A	07264	0808	C	L63FR-FREON PUMP INLET PRESS CONST	3729	08174	08234	10014	84264

**EXAMINABLE**

FILE VII  
SPACELAB OMRS INCORPORATION LOG

<u>NUMBER</u>	<u>TITLE</u>	<u>OMRS FILE</u>	<u>PRCBD</u>	<u>DATE INC</u>	<u>REQUIREMENT NUMBER AFFECTED</u>
ML0057	SL-VE-073, VOLUME II	SPICE	1233	01-16-81	INITIAL BASELINE
ML0083	SPICE REQUIREMENTS	SPICE	1392	06-22-81	L7200.0020
ML0043	SL CPSE VIEWPORTS	L8300	1552	11-03-81	NEW REQUIREMENTS
ML0089M	LIGHTING	L7600	1552	11-03-81	NEW REQUIREMENTS
ML0090M	PALLET STRUCTURE	L8100	1552	11-03-81	NEW REQUIREMENTS
ML0091M	MODULE STRUCTURE	L3300	1552	11-03-81	NEW REQUIREMENTS
ML0099M	SAM	L7300	1552	11-03-81	NEW REQUIREMENTS
ML0125	REVISED REQUIREMENT NUMBERS, SL	L3300 L7300 L8300	1591	12-08-81	L3300.0030,L72N0000.000,L72N1000.000,L72N1000.010 L72N1000.020,L72N1000.030,L72N1000.040,L72N1000.050 L72N2000.000,L72N2000.010 L83VP0.0010,L83VP0.0020,L83VP0.0030,L83VP0.0040
ML0107A	L60 - VENT AND RELIEF	L6000	1646	01-25-82	NEW REQUIREMENTS
ML0106M	SL INTERCOMM REQUIREMENTS	L7200	1644	01-25-82	L7500.0010,L7500.0040, NEW REQUIREMENTS
ML0053A(M)	CDMS REQUIREMENTS	L7200	1644	01-25-82	NEW REQUIREMENTS
ML0119M	INITIAL SL SYSTEM REQUIREMENTS	L0000	1658	02-08-82	L0000.0010,L0000.0020, NEW REQUIREMENTS
ML0055A(MI)	CCTV	L7500	1668	03-09-82	NEW REQUIREMENTS
ML0117A(M)	VFI SPECIAL ACCURACY MEASUREMENTS	L7800	1698	03-03-82	NEW REQUIREMENTS
ML0109A(M)	VFI SENSORS	L7800	1698	03-03-82	NEW REQUIREMENTS
ML0105A	SL-1 VFI CONTINUITY CHECKS	L7800	1698	03-03-82	NEW REQUIREMENTS
ML0104A	SL-1 VFI COMMAND RESPONSE	L7800	1698	03-03-82	NEW REQUIREMENTS
ML0134	L750R-VAS STORAGE CONDITIONS	L750R	1877	06-04-82	NEW REQUIREMENTS
ML0128	L76/L00 CONSTRAINTS	L76/L00	1875	06-04-82	L76RC.0001,L76RC.0010,L76RC.0020,L76RC.0030 L76RC.0040, NEW REQUIREMENTS
ML0159	L76F-LIGHTING UPDATE	L7600	1881	06-18-82	L76F0100.010,L76F0100.020,L76F0100.030,L76F0200.010 L76F0200.020,L76F0200.050,L76F0200.090,L76F0300.000 L76F0300.010,L76F0300.020,L76F0300.030

2.6 - 13



REQUIREMENT					
NUMBER	REV	DESCRIPTION	MEAS/STIMU	SPECIFICATION	INTERVALS/CONSTRAINTS/REMARKS
L0000000.011	ML0349	VERIFY CONFIG OF STAGED SL-2 EQUIP		PER MDTSCO DWG 5000017	A: PL02 B: C: ASSEMBLY PART NUMBER, MATERIALS, PROCESSES, TORQUE VALUES AND DIMENSIONS OF STAGED EQUIPMENT SHALL BE VERIFIED AT INSTALLATION.
L0000000.020	ML0057 ML0119M  ML0270 KL0767M	VERIFY EQUIPMENT EXTERIOR CLEANLINESS		VISIBLY CLEAN AS FOLLOWS:  FREE FROM VISIBLE CONTAMINATION SUCH AS PARTICLES, SCALE CORROSION, DIRT, GREASE, OIL OR OTHER FOREIGN MATERIAL.	A: PLA B: C: AS ACCESSIBLE FOR INSPECTION PRIOR TO CLOSEOUT FOR FLIGHT.  VISIBLE TO UNAIDED EYE WHEN EXAMINED UNDER WHITE LIGHT (50 TO 150 FT CANDLES) FROM A DISTANCE OF 1 TO 2 FT.  APPLICABLE TO INTERFACING PAYLOAD HARDWARE EXTERIORS AS WELL AS SPACELAB EQUIPMENT.  GSE CLEAN. SHALL BE SUCH THAT FLIGHT EQUIPMENT CLEANLINESS IS MAINTAINED.
L0000000.027	ML1030M	VERIFY SL-2 CLOSEOUT CONFIG			A: PL02 B: C: OPF CLOSEOUT
		1. HDRR 1&2 TAPE POSITIONS		TAPES AT 50%	1. LAST OPERATION OF BOTH HDRR'S PRIOR TO FLIGHT MUST BE RUN IN FAST FORWARD TO EOT, THEN REPRO AT 16 MBS TO BOT, THEN RECORD AT 32 MPS TO APPROX 50%.
		2. SSC CONFIGURATION		LOADED WITH SCOS	

EXAMINABLE

2.6 - 14

REQUIREMENT					
NUMBER	REV	DESCRIPTION	MEAS/STIMU	SPECIFICATION	INTERVALS/CONSTRAINTS/REMARKS
3.		BUC CONFIGURATION		LOADED WITH SCOS	
4.		SCOS			
		ALL SCOS LIMITS & STATUS		ENABLED	
5.		SPDB (RELAYS)		NOT CONNECTED	5. ALL UNNAMED RELAYS NOT USED.
		S/S AC TO EXP INVERTER (K7)		CONNECTED	
		EXP AC TO S/S INV (K8)		OFF	
		ECS S/S AC1 (K10)		OFF	
		ECS S/S AC3 (K11)		OFF	
		CDMS S/S DC1 (K1)		OFF	
		CDMS S/S DC2 (K2)		OFF	
		CDMS S/S DC3 (K3)		OFF	
		CDMS S/S DC4 (K13)		OFF	
		RAU DC1/2 (K15)		OFF	
		RAU DC3/4 (K14)		OFF	
6.		EPDB CB'S & RELAYS			
		EPDB1 (CB, RELAYS):			
		ALL CB'S		OPEN	
		ALL RELAYS		OPEN	
		EPDB3			
		CB01 DC31		CLOSED	EXP 13 L 5
		K1 AC31		OPEN	
		CB02 DC32		CLOSED	VFI
		K2 AC32		OPEN	
		CB03 DC33/34		CLOSED	EXP 13 & 5
		K3 AC33/34		OPEN	
7.		H/W END ITEMS POWER STATUS			7. DENOTES STATUS OF INTERNAL RELAYS/CIRCUIT BREAKERS.
		S/S INVERTER		OFF	
		EXP INVERTER		OFF	
		FREON PUMP 1		OFF	
		FREON PUMP 2		OFF	
		SSC		OFF	
		BUC		OFF	
		EXC		OFF	
		SS I/O UNIT		OFF	COUPLERS LATCHED IN "A" POSITION.
		EXP I/O UNIT		OFF	COUPLERS LATCHED IN "A" POSITION.

2.6 - 15

REQUIREMENT				
NUMBER	REV	DESCRIPTION	MEAS/STIMU	SPECIFICATION
		MMU		OFF
		HD RR 1		OFF
		HD RR 2		OFF
		HRM		OFF
		RAU S/S A		OFF
		RAU S/S F		OFF
		RAU S/S Y		OFF
		RAU S/S B		OFF
		RAU S/S C		OFF
		RAU S/S Z		OFF
		RAU EXP 20		OFF
		RAU EXP 21		OFF
		RAU EXP 22		OFF
		RAU EXP 23		OFF
		RAU EXP 24		OFF
		RAU EXP 5		OFF
		RAU EXP 6		OFF
8.		FREON PUMP GSE PORTS (2 QDS)		CAPPED
				LEAKAGE TEST FOLLOWING CAPPED
9.		AFT FLIGHT DECK R7 PANEL SWITCHES		
		EPDS VOLT/AMP (ROTARY SW OF DVM)		VOLTS MAIN
		EXP AC BUS (3 POS SW)		CENTER
		S/S AC/DC POWER (3 POS SW)		CENTER
		S/S & EXP INV'S (3 POS SW)		CENTER
		S/S AC BUS (3 POS SW)		CENTER
		IECM ASCENT/DESCENT		OFF
		T/R POWER		AUTO
		T/R RECORD		AUTO
		VFI ASCENT/DESCENT		OFF
		IPS JETT		DISABLE
		TEST (3 POS SW)		CENTER
				ANY 3 POSITION SWITCH WHICH IS A MOMENTARY SPRING LOADED SWITCH, SHOULD BE IN CENTER POSITION. ANY OTHER POSITION INDICATES A MALFUNCTIONING SWITCH. ALL UNNAMED SWITCHES NOT USED.

2.6 - 16

REQUIREMENT				
NUMBER	REV	DESCRIPTION	MEAS/STIMU	SPECIFICATION
		S/S DDU DISPLAY DURATION (ROTARY SW)		1
		BRIGHTNESS (ROTARY SW)		AS REQUIRED
		POWER DDU/KB		OFF
		S/S KYBD		
		CMTR SEL		S/S
		KB POWER		ENABLE
		KB (RESET) 3 POS SW		CENTER
		EXP DDU		
		DISPLAY DURATION (ROTARY SW)		1
		BRIGHTNESS		AS REQUIRED
		POWER DDU/KB		OFF
		EXP KYBD		
		CMTR SEL		EXP
		KB POWER		ENABLE
		KB (RESET) 3 POS SW		CENTER
		CONTINGENCY CONTROL PANEL (IPS)		
		POWER		OFF
		LAMP TEST		DOWN (OFF)
		CROSS ELEVATION		OFF
		ROLL		OFF
		ELEVATION		CENTER (OFF)
		GIMBAL/PAYLOAD SEP		CENTER (OFF)
		PAYLOAD CLAMP		CENTER (OFF)
		JETTISON ARM/SAFE		SAFE
		JETTISON		OFF (DOWN) WITH GUARD COVER ON
		DEPLOYMENT POINTING PANEL (IPS)		
		MANUAL POINTING CONTROL SECTION		
		POWER (S5)		OFF
		AFD POWER DISTRIBUTION BOX (L14)		

ALL UNNAMED SWITCHES NOT USED.

2.6 - 17

REQUIREMENT				
NUMBER	REV	DESCRIPTION	MEAS/STIMU	SPECIFICATION
		CBI S/S RAU POWER		ON
		CB2 S/S RAU POWER		ON
		SWI DDU POWER		AC 2
		VFI CONTROL PANEL (R15)		
		IECM		OFF 1
		VFI		OFF 1
		TRANSITION MODE		INHIBIT
		SMTG		
		AURAL ANNUNCIATOR VOL		MAX CW
		AURAL ANNUNCIATOR MODE		3 TONES
L0000000.035		VERIFY PALLET PLUS PAYLOAD CLEARANCE		
	ML0199			A: PLP
	ML0349			B:
	ML0573			C: PAYLOAD LAUNCH AND LANDING CONFIGURATION STATIC ENVELOPE. EXCEPT FOR SUPPORT TRUNNIONS AND FLEXIBLE INSULATION
		RADIUS ABOUT PALLET X-AXIS		88.43 IN. MAX.
L0000000.050		VFY ELEC BONDING OF ELEC LRU'S/UNITS		
	ML0119M			A: PLA
	ML0270	BONDING TO MOUNTING STRUCTURE		B:
				C: APPLIES TO KSC INSTALLED EQUIPMENT ONLY. BONDING PER MIL-B-5087, CLASS R.
				2.5 MIL OHMS MAX.
L0000000.070		DETERMINE MASS PROP OF INTEG SPACELAB		
	ML0866B			A: PL02,03
	ML0932M			B:
				C: GENERATE AND MAINTAIN SEPARATE MODULE, PALLET, AND OTHER PAYLOAD ELEMENT WEIGHT & C.G. HISTORY LOG BOOKS (WEIGHT AND C.G. DATA TO BE RECORDED IN LOG BOOKS). WEIGHT AND C.G. DATA FOR AS WEIGHED CONFIGURATION TO BE TRANSMITTED TO MDTSCO- HUNTSVILLE OPERATIONS. UPDATE LOG BOOK EACH TIME AN ITEM IS ADDED OR REMOVED.

REPLACEMENT

2.6 - 18

REQUIREMENT				
NUMBER	REV	DESCRIPTION	MEAS/STIMU	SPECIFICATION
		1. MASS MEASUREMENT		ACCURACY TO +/- 0.2%
		2. CENTER OF GRAVITY MEASUREMENT ACCURACY		X = +/- 0.4 IN. Y = +/- 0.4 IN.
L0000000.075	ML0898M	MODULE TOXIC OUTGASSING TEST  PERFORM PER NMB8060.1B FLAMMABILITY, ODOR AND OUTGASSING REQUIREMENTS, AND TEST PROCEDURES FOR MATERIALS IN ENVIRONMENTS THAT SUPPORT COMBUSTION.		
				A: PLMF2-90 B: C: TEST DURATION SHALL BE 6 HOURS. SL SUBSYSTEMS, INCLUDING CCTV (EXCEPT SL TV CAMERAS, MONITORS, AND VIEW FINDER MONITORS) ACTIVE IN ON-ORBIT MODE. SL CLOSED UP. ALL POSSIBLE FLIGHT EQUIPMENT (EXCEPT LIOH CANNISTERS, PPO2 SENSORS AND AMPLIFIERS) INSTALLED, (IDENTIFY FLIGHT EQUIPMENT NOT INSTALLED). REMOVE ALL POSSIBLE NON FLIGHT EQUIPMENT (IDENTIFY ANY NON FLIGHT EQUIPMENT INSTALLED IN MODULE). SAMPLE AT OR NEAR CABIN FAN INLET.
L0000000.095	ML1187M	VFY INTEGRATED HRM INPUT INTERFACE		
		1. EXPERIMENT INPUT CHANNELS		
		- CHANNELS 1-16 - 2 DIRECT ACCESS CHANNELS (DACH)		CORRECT DATA RECEIVED
		2. SPACELAB INPUT CHANNELS		
		- HDRR - PLR - EXP. DATA BUS - SS DATA BUS		CORRECT DATA RECEIVED
				A: PLAF4-90 B: C: ALL EXPERIMENTS TO OUTPUT DATA VIA HRM. ONLY VERIFY INPUT CHANNELS THAT ARE UTILIZED.
				2. VERIFY IF NEW INSTALLATION OR INTERFACE BROKEN.

2.6 - 19

REPLACED

REQUIREMENT		MEAS/STIMU	SPECIFICATION	INTERVALS/CONSTRAINTS/REMARKS
NUMBER	REV	DESCRIPTION		
		- GMT - 3 VOICE INPUTS		
L0000000.120	KL0767M	DELETED		
L0000000.210	ML0803A	RECONFIGURE NEG PRESS RELIEF VLVS		A: PLM;C B: CONTINGENCY IS FERRY FLIGHT.
	ML1173	MODULE AND TUNNEL	COVERS OPENED AND LOCKED	C: POST LANDING AND PREFERRY FLIGHT. RECONFIGURE COVERS TO PREVENT VIBRATION DAMAGE DURING FERRY FLIGHT.
L0000000.220	MLI108M	SL MODULE SUBFLOOR AIR PURGE		A: PL03;C B: CONTINGENCY IS HALON (ABOVE BACKGROUND) LEAKAGE DETECTED C: SUBFLOOR AIR PURGE TO TAKE PLACE AS LATE AS PRACTICAL BEFORE OUTGASSING TEST. PURGE BOTH FORWARD TO AFT DIRECTION AND AFT TO FORWARD DIRECTION. HALON LEAKAGE DETECTED PER REQUIREMENT L60N0000.090
		TEMPERATURE	65 +/- 5 DEG F	
		HUMIDITY	LESS THAN OR EQUAL TO 50% RH	
		CLEANLINESS	GUARANTEED CLASS 5000 (HEPA FILTERED)	
		FLOW	200 CFM +/- 50 CFM INLET AIR	
		DURATION	30 MIN EACH DIRECTION	
L0000100.010	SL0264M	EVA ENVELOPE HAZARDS INSPECTION		A: PLA B:

2.6 - 20

EXAMINER

NUMBER	REV	REQUIREMENT	DESCRIPTION	MEAS/STIMU	SPECIFICATION	INTERVALS/CONSTRAINTS/REMARKS
			<p>TO MINIMIZE HAZARDS TO EVA CREWMAN FOR CONTINGENCY, UNSCHEDULED AND PLANNED EVA'S, ALL SPACELABS, PRIOR TO INSTALLATION IN THE ORBITER, SHALL HAVE A HAZARDS INSPECTION TO IDENTIFY SHARP</p>		<p>TABLE L0000100.010 TO BE USED AS AN INSPECTION GUIDELINE AND FOR RE-SOLVING QUESTIONABLE CONDITIONS; MEASUREMENT OF ALL EDGES, PROTRUSIONS, ETC., PER TABLE NOT REQUIRED.</p>	<p>C:  REMARK - MULTI-LAYER INSULATION OR ACCESS PANELS NOT TO BE REMOVED FOR INSPECTION. FLT CREW PARTICIPATION DESIRABLE BUT NOT MANDATORY.</p>
			<p>EDGES/CORNERS/SURFACES/ PROTRUSIONS WITHIN EVA TRANSLATION OR WORK ENVELOPES AS SHOWN IN OMRS FIGURES L0000100.010A AND L0000100.010B</p>			
			<p>THE HAZARDS TEAM WILL RECOMMEND ACCEPTABLE METHODS AND MATERIALS, AS NECESSARY, TO ELIMINATE IDENTIFIED EVA HAZARDS. HAZARDS WHICH CANNOT BE ELIMINATED, i.e., THE HAZARD MUST EXIST FOR SUCCESSFUL ORBITER /PAYLOADS OPERATION, WILL BE DOCUMENTED, AND THE JSC TEAM MEMBER WILL SUPPLY THE INFORMATION TO THE APPROPRIATE JSC EVA PLANNERS. HAZARDS WHICH RESULT IN DESIGN CHANGES OR SCHEDULE IMPACTS TO SPACELAB WILL BE FORWARDED TO LEVEL II CHANGE BOARD FOR DISPOSITION .</p>			

FINAL COPY



1.0 SHARP EDGES, CORNERS, AND PROTRUSION HAZARDS.

THE CRITERIA PROVIDED BELOW SHALL BE IMPLEMENTED FOR EVA HAZARDS INSPECTION.

1.1 DEFINITIONS.

A. FOR THE PURPOSES OF THESE CRITERIA THE FOLLOWING COMMONLY USED TERMS MAY CONSTITUTE POTENTIAL HAZARDS IF THEY ARE "UNACCEPTABLE" AS DEFINED HEREIN:

SHARP EDGES  
SHARP CORNERS  
SHARP POINTS  
JAGGED EDGES  
SNAGS  
PROJECTIONS  
PROJECTING CORNERS  
PROJECTING EDGES  
PROTRUSIONS

ROUGH SURFACES  
BURRS  
SPINDERS  
WELTERS  
SPINDERS  
METAL FILLINGS  
METAL CHIPS  
MATERIAL DEFECTS

B. EDGES AND CORNERS:

EDGE - THE MEETING OF TWO SURFACES NOT OF THE SAME PLANE

CORNER - THE MEETING OF MORE THAN TWO SURFACES NOT OF THE SAME PLANE

1.2 GENERAL REQUIREMENTS.

A. HARDWARE - ALL ITEMS TO BE PHYSICALLY HANDLED, OPERATED, OR OTHERWISE USED DIRECTLY OR INDIRECTLY BY CREWMEN SHALL CONFORM TO THE CRITERIA AS SPECIFIED HERE

B. EQUIPMENT/HARDWARE CONFIGURATIONS - EQUIPMENT AND HARDWARE INSTALLATIONS, LAYOUTS, AND GENERAL CONFIGURATIONS TO WHICH CREWMEN ARE DIRECTLY EXPOSED SHALL CONFORM TO CRITERIA AS SPECIFIED HERE.

C. USE ENVIRONMENTS - ENVIRONMENTS TO BE CONSIDERED AS THE FOLLOWING:

1. ONE-GRAVITY GROUND TEST CONDITIONS AND SPACECRAFT ORIENTATION CONFIGURATIONS.
2. ZERO-GRAVITY CONDITIONS.
3. OTHER GRAVITY CONDITIONS IMPOSED BY MISSION OR WHICH COULD REASONABLY BE IMPOSED ON THE CREWMEN DURING MISSION PHASES (G'S IMPOSED BY BOOSTER SEPARATION, DOCKING AND UNDOCKING, THRUSTER FIRINGS, LAUNCH AND LANDING).
4. MAXIMUM CREWMAN ACCELERATION TO BE CONSIDERED DURING ZERO-GRAVITY PHASES OF MISSION SHALL BE SIX FEET PER SECOND, PER SECOND.

- D. EDGES, CORNERS, SURFACE QUALITY, AND PROTRUSIONS - NO SHARP EDGES OR CORNERS, BURRS, PINS, ROUGH SURFACES, SNAG POINTS, OR OTHER PROPERTIES WHICH CAN CAUSE PHYSICAL INJURY TO CREWMEN. PROPERTIES SHALL ALSO NOT INDUCE TEARING OF CREWMAN APPAREL OR EXCESSIVE WEAR DURING REASONABLE USE AND ACTIVITY.
- E. PROJECTIONS, PROTRUSIONS, AND SNAGGING POINTS - NO PROTRUDING/PROJECTING CORNERS, EDGES, KNOBS, OR OTHER ITEMS WHICH COULD CREATE SNAGGING, BUMPING, TRIPPING, OR OTHERWISE CAUSE PHYSICAL INJURY TO PERSONS USING OR PASSING BY THESE OBJECTS DURING REASONABLE USE AND ACTIVITY.

1.3 SPECIFIC REQUIREMENTS.

THE FOLLOWING PROVIDES MINIMUM REQUIREMENTS FOR RADII, RECESSING, ETC. TO PRECLUDE SHARP EDGES AND OTHER HAZARDS DESCRIBED ABOVE. SINCE THE REQUIREMENTS DO NOT FULLY ENCOMPASS HAZARDS, THE BASIC REQUIREMENTS OF PARAGRAPHS 1.2D AND E TAKE PRECEDENCE OVER THESE CRITERIA (VALUES IN INCHES).

A. EDGE AND CORNER RADII

<u>APPLICATION</u>	<u>RADIUS OUTER</u>	<u>RADIUS INNER</u>	<u>REMARKS</u>
EXPOSED EDGES OF SHEET METAL, FLANGES, AND OTHER HARDWARE	.04"	--	
OPENINGS, PANELS, COVERS (CORNER RADII)	.25" .17"	.12" .06"	PREFERRED MINIMUM
EXPOSED CORNERS OF METAL, BOXES, EQUIPMENT, ETC.	.50"	--	
B. PROTRUSIONS			
SMALL PROTRUSIONS LESS THAN 3/16 INCH LONG.	.04"	--	ABSOLUTE UNLESS PROTRUDING CORNER IS GREATER THAN 120 DEGREES
LARGE PROTRUSIONS GREATER THAN 3/16 INCHES LONG.	.25"		

2.6 - 23

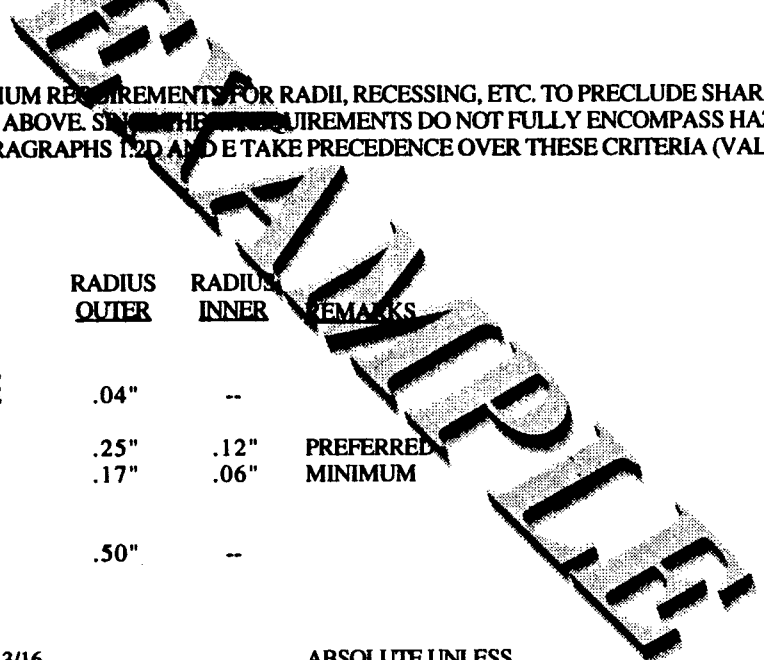

TABLE L0000100.010

**APPLICATION**

**REMARKS**

SCREW HEADS, BOLTS, NUTS, NUT PLATES, EXCESS THREADS AND RIVETS WHICH CAN BE CONTACTED BY CREWMEN.

ALL SCREW AND BOLT HEADS SHALL FACE OUTSIDE OF HARDWARE, IF POSSIBLE. WHERE NUTS, NUT PLATES AND THREADS ARE EXPOSED, THEY SHALL BE SECURELY COVERED. RECESSED HEADS OR USE OF RECESSED WASHERS ARE RECOMMENDED. OVERALL HEIGHT OF HEADS SHALL BE WITHIN .125 OR COVERED UNLESS AT LEAST 7 HEAD DIAMETERS APART FROM CENTER TO CENTER. HEIGHT OF ROUND HEAD OR OVAL HEAD SCREWS IS NOT LIMITED. SCREW OR BOLT HEADS OVER .25 DEEP MUST BE RECESSED OR HAVE FAIRING OVER THEM.

RIVET HEADS SHALL FACE OUT ON ALL AREAS ACCESSIBLE TO CREWMEN AND SHALL PROTRUDE NO MORE THAN .06 UNLESS SPACED MORE THAN 3.5 HEAD DIAMETERS FROM CENTER TO CENTER. IN ALL EXPOSED AREAS WHERE UPSET ENDS OF RIVETS EXTEND MORE THAN, .12, OR .5 OF UPSET END DIAMETER IF OVER .12, A FAIRING SHALL BE INSTALLED OVER THEM. THIS APPLIES TO EXPLOSIVE, BLIND OR PULL RIVETS, ETC. UPSET ENDS OF RIVETS SHALL HAVE EDGES CHAMFERED 45 DEGREES OR GROUND TO A MINIMUM RADIUS OF .04.

A MAXIMUM GAP OF .02 WILL BE ALLOWED ONLY BETWEEN ONE SIDE OF A FASTENER HEAD AND ITS MATING SURFACE.

BURRS MUST BE PREVENTED OR ELIMINATED. USE OF ALLEN HEADS IS PREFERRED. TORQUESET SLOTTED OR PHILLIPS HEAD SCREWS MUST BE COVERED WITH TAPE OR OTHER PROTECTIVE MATERIALS OR BE INDIVIDUALLY DEBURRED PRIOR TO FLIGHT.

WHERE BOLTS, ETC., ARE TORQUED AND INSPECTION PERFORMED, THE MATERIAL USED TO SIGNIFY THAT TORQUE HAS BEEN APPLIED OR THAT INSPECTION HAS OCCURRED, SHALL NOT ITSELF CONSTITUTE A SHARP EDGE.

**LATCHING DEVICES**

ALL LATCHING DEVICES SHALL BE COVERED IN A MANNER THAT DOES NOT ALLOW GAPS OR OVERHANGS THAT CAN CATCH FABRICS, OR PRESSURE SUIT APPENDAGES, OR SHALL BE DESIGNED TO PRECLUDE CATCHING OF FABRICS AND PRESSURE SUIT APPENDAGES.

ALL SURFACES AND EDGES SHALL BE SMOOTH, ROUNDED AND BURR FREE.

**LAP JOINTS IN SHEET METAL  
MISMATCHING OF ADJACENT SURFACES**

ALL SURFACES SHALL BE MATED WITHIN .03 OF FLAT SURFACE EDGES, OR SHALL BE BUTTED OR RECESSED. ALL EXPOSED EDGES MUST BE SMOOTHED AND RADIUS .06 MINIMUM (AS ABOVE), CHAMFERED 45 DEGREES, OR COVERED WITH AN APPROPRIATE MATERIAL TO PROTECT THE CREWMAN, HIS PGA GLOVES, OR APPAREL.

**SHEET METAL STRUCTURE, BOX AND  
CABINET THREE-PLANE INTERSECTING  
CORNERS.**

SPHERICAL WELDED OR FORMED RADII ARE REQUIRED UNLESS CORNERS ARE PROTECTED WITH COVERS.

**C. SURFACE QUALITY.**

THE SURFACE ROUGHNESS HEIGHT (IN MICRO-INCHES) OF MATERIALS SHALL NOT EXCEED A MAXIMUM OF 125 MICRO-INCHES EXCEPT WHERE ROUGHER SURFACES ARE SPECIFICALLY REQUIRED FOR SPECIAL PURPOSES.

NUMBER	REV	COMPONENT	CONDITION	CONSTRAINTS								
L00R0.0030	ML0057 ML0135M	REVISED AND RENUMBERED AS L000R000.010										
L000R000.010	ML0135M	SPACELAB EQUIPMENT	INSTALLATION/REMOVAL	1. APPLICABLE MDTSCO-HO DRAWING(S) SHALL BE USED.								
L00R0.0040	ML0057 ML0135M	RENUMBERED AS L000R000.020										
L000R000.020	ML0135M	SPACELAB EQUIPMENT	DRAWING CHANGES	1. ANY PROPOSED CHANGES TO MDTSCO DRAWINGS OR THEIR INDENTURES SHALL BE SUBMITTED TO MDTSCO-HUNTSVILLE SYSTEMS ENGINEERING FOR PROCESSING AND APPROVAL.								
L00R0.0050	ML0057 ML0135M	RENUMBERED AS L000R000.030										
L030R000.030	ML0135M	SPACELAB EQUIPMENT	NON-COMPLIANCE	1. REVIEW, APPROVAL AND INCORPORATION INCLUDING NON-COMPLIANCE REQUESTS (WAIVERS) ARE SUBJECT TO SL/CCB APPROVAL PRIOR TO IMPLEMENTATION OR ACCEPTANCE.  2. ALL DEVIATIONS ARE SUBJECT TO SL/CCB APPROVAL.								
L00R0.0060	ML0057 ML0135M	REVISED AND RENUMBERED AS L000R000.040										
L000R000.040	ML0135M	SPACELAB EQUIPMENT	INTEGRATION AND CHECKOUT	1. EQUIPMENT INTEGRATION AND CHECKOUT SHALL BE PERFORMED WITHIN THE FOLLOWING ENVIRONMENTAL CONSTRAINTS: <table border="0"> <tr> <td>TEMPERATURE</td> <td>68 TO 77 DEG F</td> </tr> <tr> <td></td> <td>(20 TO 25 DEG C)</td> </tr> <tr> <td>RELATIVE HUMIDITY</td> <td>50% MAXIMUM</td> </tr> <tr> <td>HYDROCARBONS</td> <td>LESS THAN 15 PPM</td> </tr> </table>	TEMPERATURE	68 TO 77 DEG F		(20 TO 25 DEG C)	RELATIVE HUMIDITY	50% MAXIMUM	HYDROCARBONS	LESS THAN 15 PPM
TEMPERATURE	68 TO 77 DEG F											
	(20 TO 25 DEG C)											
RELATIVE HUMIDITY	50% MAXIMUM											
HYDROCARBONS	LESS THAN 15 PPM											
L00R0.0070	ML0057 ML0135M	REVISED AND RENUMBERED AS L000R000.050										

2.6 - 25

EXPIRED

NUMBER	REV	COMPONENT	CONDITION	CONSTRAINTS										
L000R000.050	ML0135M	SPACELAB EQUIPMENT	TRANSPORTATION	<p>1. TRANSPORTATION PROVISIONS SHALL MAINTAIN EQUIPMENT WITHIN THE FOLLOWING ENVIRONMENTAL CONSTRAINTS (WATER SYSTEM DESERVICED):</p> <p>A) ALL EQUIPMENT</p> <table> <tr> <td>TEMPERATURE</td> <td>14 TO 131 DEG F (-10 TO 55 DEG C)</td> </tr> <tr> <td>RELATIVE HUMIDITY</td> <td>10 TO 90%</td> </tr> <tr> <td>CLEANLINESS LEVEL</td> <td>100K (FED. STD. 209B)</td> </tr> </table> <p>B) ACCELERATION FOR SPACELAB FLIGHT</p> <table> <tr> <td>HARDWARE</td> <td>X = +/- 0.8 G FORE &amp; AFT Y = +/- 0.9 G LATERAL Z = 1.0 +/- 1.3 G</td> </tr> <tr> <td>VERTICAL</td> <td>FREQUENCY 50 HZ MAX</td> </tr> </table> <p>2. RACK TRANSPORTATION PROCEDURES PER PR-SN-1005</p> <p>3. RACK TRANSPORTATION TO UTILIZE RACK HANDLING AND TRANSPORT KITS; CI-612.050 (DOUBLE RACK) AND CI-612.065 (SINGLE RACK) WITH RESPECTIVE O&amp;M MANUALS, MA-SN-050 ISSUE 5/1, AND MA-SN-065, ISSUE 4/1.</p> <p>PALLET TRANSPORTATION TO UTILIZE PALLET TRANSPORT CAGE 612118, AND ATTENUATION FRAME 612119, WITH RESPECTIVE O&amp;M MANUALS.</p>	TEMPERATURE	14 TO 131 DEG F (-10 TO 55 DEG C)	RELATIVE HUMIDITY	10 TO 90%	CLEANLINESS LEVEL	100K (FED. STD. 209B)	HARDWARE	X = +/- 0.8 G FORE & AFT Y = +/- 0.9 G LATERAL Z = 1.0 +/- 1.3 G	VERTICAL	FREQUENCY 50 HZ MAX
TEMPERATURE	14 TO 131 DEG F (-10 TO 55 DEG C)													
RELATIVE HUMIDITY	10 TO 90%													
CLEANLINESS LEVEL	100K (FED. STD. 209B)													
HARDWARE	X = +/- 0.8 G FORE & AFT Y = +/- 0.9 G LATERAL Z = 1.0 +/- 1.3 G													
VERTICAL	FREQUENCY 50 HZ MAX													
L000R0.0090	ML0057 ML0135M	REVISED AND RENUMBERED AS L000R000.060												
L000R000.060	ML0135M ML0619	SPACELAB EQUIPMENT	STORAGE	<p>1. ENVIRONMENT FOR EQUIPMENT STORAGE SHALL BE WITHIN THE FOLLOWING CONSTRAINTS:</p> <table> <tr> <td>TEMPERATURE (EXCEPT PALLET STRUCTURE)</td> <td>40 TO 131 DEG F (4 TO 55 DEG C)</td> </tr> <tr> <td>TEMPERATURE (PALLET STRUCTURE)</td> <td>4 TO 131 DEG F (-10 TO 55 DEG C)</td> </tr> <tr> <td>RELATIVE HUMIDITY</td> <td>15 TO 90%</td> </tr> <tr> <td>CLEANLINESS LEVEL</td> <td>100K (FED STD 209B)</td> </tr> </table>	TEMPERATURE (EXCEPT PALLET STRUCTURE)	40 TO 131 DEG F (4 TO 55 DEG C)	TEMPERATURE (PALLET STRUCTURE)	4 TO 131 DEG F (-10 TO 55 DEG C)	RELATIVE HUMIDITY	15 TO 90%	CLEANLINESS LEVEL	100K (FED STD 209B)		
TEMPERATURE (EXCEPT PALLET STRUCTURE)	40 TO 131 DEG F (4 TO 55 DEG C)													
TEMPERATURE (PALLET STRUCTURE)	4 TO 131 DEG F (-10 TO 55 DEG C)													
RELATIVE HUMIDITY	15 TO 90%													
CLEANLINESS LEVEL	100K (FED STD 209B)													

EXAMPLE

NUMBER	REV	COMPONENT	CONDITION	CONSTRAINTS
L000R000.070	ML0135M	SPACELAB EQUIPMENT	ENVIRONMENTAL PROTECTION	1. EQUIPMENT SHALL BE PROTECTED FROM CORROSIVE ATMOSPHERIC EFFECTS (SALT FALLOUT, CORROSIVE FUMES, ETC).
L00R0.0110	ML0057 ML0135M	RENUMBERED AS L000R000.080		
L000R000.080	ML0135M	SPACELAB EQUIPMENT	TEMPERATURES	1. EQUIPMENT TEMPERATURES SHALL BE MAINTAINED ABOVE LOCAL DEW POINT TO PRECLUDE CONDENSATION FROM FORMING.  CAUTION: CONDENSATION CAN CAUSE DAMAGE TO FLIGHT EQUIPMENT.
L00R0.0231	ML0057 ML0135M	DELETED		
L00R0.0240	ML0057 ML0135M	DELETED		
L00R0.0250	ML0057 ML0135M	DELETED		
L00R0.0260	ML0057 ML0135M	RENUMBERED AS L000R000.160		
L000R000.160	ML0135M	SPACELAB GSE INTERFACE	FLUID CONNECTIONS	1. ALL GSE FLUID CONNECTIONS SHALL BE BLOWN DOWN AND/OR VISUALLY VERIFIED TO BE CONTAMINANT-FREE PRIOR TO EACH CONNECTION TO SPACELAB EQUIPMENT.
L00R0.0270	ML0057 ML0135M	RENUMBERED AS L000R000.170		
L000R000.170	ML0135M	SPACELAB GSE INTERFACE	SERVICE LINES	1. GSE SERVICE LINES SHALL BE ADEQUATELY SUPPORTED TO MINIMIZE STRESSES ON SPACELAB CONNECTORS/LINES.
L00R0.0280	ML0057 ML0135M	RENUMBERED AS L000R000.180		

NUMBER	REV	COMPONENT	CONDITION	CONSTRAINTS
L000R000.180	ML0135M	SPACELAB GSE INTERFACE	CIRCUITS	1. ALL GSE INTERFACE CIRCUITS SHALL BE VERIFIED FOR PROPER OPERATION PRIOR TO CONNECTION TO SPACELAB EQUIPMENT.
L00R0.0290	ML0057 ML0135M	RENUMBERED AS L000R000.190		
L000R000.190	ML0135M	SPACELAB GSE INTERFACE	TEST CABLING	1. TEST CABLING SHALL BE ADEQUATELY SUPPORTED TO MINIMIZE STRESSES ON SPACELAB HARNESSES.
L00R0.0300	ML0057 ML0135M	RENUMBERED AS L000R000.200		
L000R000.200	ML0135M	SPACELAB GSE INTERFACE	TEST LEADS	1. CURRENT PROTECTED TEST LEADS SHALL BE USED FOR ALL POWER-ON TEST MEASUREMENTS FROM SPACELAB EQUIPMENT CONNECTIONS.
L00R0.0310	ML0057 ML0135M	DELETED		
L00R0.0320	ML0057 ML0135M	RENUMBERED AS L000R000.210		
L000R000.210	ML0135M	ELECTRICAL/ELECTRO-MECHANICAL DEVICES	EQUIPMENT HAZARD	LEAK DETECTION SOLUTION SHALL NOT BE APPLIED TO VALVE SOLENOID HOUSINGS, ELECTRICAL INTERFACES OR ELECTRO-MECHANICAL DEVICES (CABLING, TERMINALS, CONNECTORS, ETC.).
L00R0.0330	ML0057 ML0135M	RENUMBERED AS L000R000.220		
L000R000.220	ML0135M	ELECTRONIC COMPONENTS	IMPACT TOOLS UTILIZATION	1. IMPACT TOOLS (HAMMERS, IMPACT WRENCHES, RIVET GUNS, ETC.) SHALL NOT BE USED ONCE ELECTRONIC COMPONENTS ARE INSTALLED.
L00R0.0341	ML0057 ML0135M	RENUMBERED AS L000R000.230		

2.6 - 28

EXAMINER

NUMBER	REV	COMPONENT	CONDITION	CONSTRAINTS
L000R000.230	ML0135M	ELECTRICAL EQUIPMENT	TEST AIDS UTILIZATION	1. TEST AIDS SUCH AS BREAKOUT BOXES, CONNECTOR SAVERS, ETC, SHALL BE USED TO MAINTAIN FLIGHT EQUIPMENT CONNECTOR INTEGRITY.
L000R000.240	ML0128M	ELECTRICAL CONNECTORS	MATING/DEMATING	1. WHEN MATING OR DEMATING ALL BAYONET-TYPE CONNECTORS, THE CONNECTOR/BODY SHALL NOT BE ROTATED WITH RESPECT TO THE RECEPTACLE. 2. WHEN MATING, THE COUPLING RING SHALL NOT BE USED TO DRAW THE CONNECTOR INTO THE RECEPTACLE. 3. ALL ELECTRICAL CONNECTORS THAT ARE DEMATED OR REPLACED SHALL HAVE THE IN-SERVICE FUNCTIONAL PATHS REVERIFIED AFTER REMATING DURING RETEST OR SUBSEQUENT TESTING.
L000R000.250	ML0128M	ELECTRICAL CONNECTORS	CONNECTING/DISCONNECTING	1. POWER SHALL BE TURNED-OFF FROM ELECTRICAL CONNECTORS PRIOR TO CONNECTING OR DISCONNECTING EQUIPMENT, POWER CABLES OR CONNECTORS.
L000R000.260	ML0128M	ELECTRICAL CONNECTORS	ELECTRICAL MODIFICATION	UPON COMPLETION OF ANY ELECTRICAL MODIFICATION WHICH CHANGES A WIRE TERMINATION IN PYROTECHNIC, DATA BUS OR POWER CIRCUITS, THAT NEW TERMINATION SHALL BE VERIFIED BY A CONTINUITY AND ISOLATION MEASUREMENT PRIOR TO THE APPLICATION OF POWER. OTHER CIRCUITS SHALL BE VERIFIED BY FUNCTIONAL TEST AS A MINIMUM.
L000R000.270	ML0128M	ELECTRICAL CONNECTORS	PROTECTIVE COVERS	1. ELECTRICAL CONNECTORS SHALL HAVE PROPER SIZE PROTECTIVE COVERS INSTALLED AT ALL CONNECTOR ENDS WHEN THEY ARE DISCONNECTED.

EXAMINED

2.6 - 29



NUMBER	REV	COMPONENT	CONDITION	CONSTRAINTS
L000R000.280	ML0323A	ELECTRICAL EQUIPMENT	AVIONICS FAN AND FREON PUMP OPERATION	<ol style="list-style-type: none"> <li>1. NORMAL OPERATION OF THE AVIONICS FANS AND FREON PUMPS SHALL BE BY SEPARATE ECS FEEDS. IE                          AV FAN 1 &amp; FREON PUMP 2 OR                          AV FAN 2 &amp; FREON PUMP 1</li> <li>2. THE FREON PUMP MUST BE OFF WHEN THE AVIONICS FAN IS COMMANDED TO HIGH SPEED (4 POLE) MODE.</li> <li>3. AFTER THE AVIONICS FAN HIGH SPEED (4 POLE) MODE IS EXECUTED, WAIT A MINIMUM OF 10 SECONDS BEFORE ACTIVATION OF ANY ADDITIONAL INVERTER POWERED EQUIPMENT, INCLUDING THE FREON PUMP.</li> </ol>
L000R000.290	ML0323A ML0595	ELECTRICAL EQUIPMENT	AVIONICS FAN OPERATION	<ol style="list-style-type: none"> <li>1. THE AVIONICS FAN SHALL BE OPERATED A MINIMUM OF 3 SECONDS IN LOW SPEED PRIOR TO ACTIVATING THE HIGH SPEED MODE.</li> <li>2. DO NOT ACTIVATE THE HIGH SPEED MODE IF A HIGH SPEED COMMAND HAS BEEN PREVIOUSLY ISSUED TO THAT SAME FAN WITHIN THE PRECEDING 5 MINUTE TIME PERIOD. (THIS IS FOR PROTECTION OF COMPONENTS IN THE PFC/ICL UNIT.)</li> </ol>
L000R000.300	ML0129M	SPACELAB AC EQUIPMENT	COMPLETE ACTIVATION	<ol style="list-style-type: none"> <li>1. WHEN ALL SUBSYSTEM AC EQUIPMENT IS ACTIVATED, THE FOLLOWING SEQUENCE AND TIME DELAYS ARE MANDATORY:                         <ol style="list-style-type: none"> <li>1. WATER PUMP</li> <li>2. AVIONICS FAN LOW SPEED (8 POLE)                                  WAIT 3 SEC MINIMUM BEFORE PROCEEDING)</li> <li>3. WATER SEPARATOR</li> <li>4. CABIN FAN                                  (WAIT 10 SEC MINIMUM BEFORE PROCEEDING)</li> <li>5. AVIONICS FAN HIGH SPEED (4 POLE)                                  (WAIT 10 SEC MINIMUM BEFORE PROCEEDING)</li> <li>6. FREON PUMP</li> </ol> </li> </ol>

EXAMINER

2.6 - 30

NUMBER	REV	COMPONENT	CONDITION	CONSTRAINTS
--------	-----	-----------	-----------	-------------

(WAIT 5 SEC MINIMUM BEFORE PROCEEDING)

7. MODULE DDU'S

PARTIAL ACTIVATION

2. FOR PARTIAL ACTIVATION, THE FOLLOWING INDIVIDUAL CONSTRAINTS ARE MANDATORY (TIME DELAYS SHALL BE OBSERVED)

1. WATER SEPARATOR ON BEFORE CABIN FAN
2. CABIN FAN ON BEFORE AVIONICS FAN HIGH FOR TWO FAN OPERATION
3. AVIONICS FAN LOW BEFORE AVIONICS FAN HIGH
4. FREON PUMP OFF BEFORE CAB FAN OR AV FAN HIGH ACTIVATION

REDUNDANCY SWITCHOVER

3. SWITCHOVER OF SL AC EQUIPMENT TO REDUNDANT EQUIPMENT.

1. AVIONICS FAN SWITCHOVER REQUIRES DEACTIVATION OF FREON PUMP AND DDU'S BEFORE REACTIVATION IN ACCORD WITH ITEMS 2, 5, 6, 7 OF THE ACTIVATION SEQUENCE. FOR PARTIAL ACTIVATION, DDU'S DO NOT HAVE TO BE DEACTIVATED.
2. CABIN FAN SWITCHOVER REQUIRES SWITCHING AVIONICS FAN TO LOW, DEACTIVATION OF FREON PUMP AND DDU'S BEFORE REACTIVATION IN ACCORD WITH SEQUENCE ITEM 5, 6, 7 OF THE ACTIVATION SEQUENCE FOR PARTIAL ACTIVATION, DDU'S DO NOT HAVE BE DEACTIVATED.

L000R000.310 ML0234M RACK MOUNTED INSTRUMENTED EQUIPMENT

REDLINE TEMPERATURES

THE INSTRUMENTED SUBSYSTEM ELECTRONICS THAT ARE COOLED BY THE AVIONICS LOOP SHALL NOT EXCEED THE FOLLOWING TEMPERATURES (HARDWARE DAMAGE MAY OCCUR IF THESE TEMPERATURES EXCEEDED)

1. SS INVERTER TEMP
2. EXP - INVERTER TEMP
3. SS-COMP MEMORY TEMP
4. BU-COMP MEMORY TEMP
5. EXP-COMP MEM TEMP

- 55 DEG C MAX (L01T018V)
- 55 DEG C MAX (L01T0138V)
- 60 DEG C MAX (L03T0113V)
- 60 DEG C MAX (L03T0143V)
- 60 DEG C MAX (L03T0173C)

EXAMINABLE

NUMBER	REV	COMPONENT	CONDITION	CONSTRAINTS
		6. MMU TEMP		60 DEG C MAX (L03T0193V)
		7. I/O-SS TEMP		62 DEG C MAX (L03T0233V)
		8. I/O-EXP TEMP		62 DEG C MAX (L03T0283C)
		9. DDU I(SS) TEMP		60 DEG C MAX (L03T0644C)
		10. DDU 3 (EXP) TEMP		60 DEG C MAX (L03T0674C)
		11. HDRR INT TEMP		45 DEG C MAX (L03T0772C)
		12. HRM TEMP		70 DEG C MAX (L03T0803C)
L000R000.320	ML0666	SPACELAB ELEC CONN	DUST CAPS	<ol style="list-style-type: none"> <li>1. ALL PLASTIC DUST CAPS ARE TO BE REMOVED FROM ALL ELECTRICAL CONNECTORS PRIOR TO OPF CLOSEOUT.</li> <li>2. PRIOR TO OPF CLOSEOUT FLIGHT METAL DUST CAPS ARE TO BE INSTALLED ON ALL ELECTRICAL CONNECTORS THAT WILL BE UNUSED DURING THE MISSION.</li> </ol>

EXAMPLE

REQUIREMENT					
NUMBER	REV	DESCRIPTION	MEAS/STIMU	SPECIFICATION	INTERVALS/CONSTRAINTS/REMARKS
L0600000.025	ML0153M ML0350	VERIFY MLI ELECT. BOND TO STRUCT.		1 OHM MAX	A: PLA B: C: BONDING PER MIL-B-50878, CLASS S
L0600000.030	ML0153M ML0350 ML0557M	VERIFY PALLET EXPOSED THERMAL COATING INTEGRITY/DEFECTS		EXPOSE NO MORE THAN ONE PERCENT OF ANY CONTINUOUS SURFACE AREA, OR ANY LOCAL AREA GREATER THAN ONE SQUARE INCH OR LONGER THAN THREE INCHES IN ANY DIMENSION, EXCEPT AS DESIGNED	A: PLP B: C: INSPECT PRIOR TO STORAGE ASSEMBLY OR INSTALLATION CLOSEOUT AND POSTFLIGHT. MAP AND PHOTOGRAPH ANY CONTAMINATED/DAMAGED AREAS THAT ARE NOT CLEAN OR REPAIRED (PRE-FLIGHT) OR HAVE CHANGED IN APPEARANCE (POSTFLIGHT). OBTAIN WIPE SAMPLES OF ANY CHALKED SURFACES.
L0600000.040	ML0153M ML0350	VERIFY THERMAL COATINGS OPTICAL PROPERTIES ABSORPTIVITY EMISSIVITY		0.36 MAX 0.20 MIN	A: PLP B: C: INSPECT PALLET AT PREFLIGHT AND POSTFLIGHT. TEST POINTS AS IDENTIFIED IN FIGURE L0600000.040.
L0600000.042	ML0631	PHOTOGRAPH PALLET THERMAL COATING			A: PL01,02 B: C: PREFLT AND POSTLANDING. TAKE COLOR PHOTOGRAPHS AND PROVIDE TO MDTSCO-HUNTSVILLE.
		3 LOCATIONS PER PALLET: (APPROXIMATE CENTER)			
		1. OUTER PNL 3 2. OUTER PNL 18 3. STB SILL BETWEEN FR2A AND 3			
L0600000.050	ML0851	VERIFY MLI EXTERNAL SURFACES			A: PLM B:

2.6 - 33

EXHAUSTED

REQUIREMENT				
NUMBER	REV	DESCRIPTION	MEAS/STIMU	SPECIFICATION
L0600000.060	ML1068	VFY IGLOO MLI EXTERNAL SURFACES		0.36 MAX 0.80 MIN
		OPTICAL PROPERTIES ABSORPTIVITY EMMISSIVITY		
		OPTICAL PROPERTIES ABSORPTIVITY EMISSIVITY		0.36 MAX 0.80 MIN
				<p>C: TRACK OPTICAL PROPERTIES OF MLI USED ON SL-1 FOR DEGRADATION. SL-1 PANELS TO BE TRACKED WILL VARY WITH MISSION HARDWARE CONFIGURATION. INSPECT AT POST FLIGHT FOR A TOTAL OF FIVE USAGES. TEST POINTS AS IDENTIFIED IN FIGURE L0600000.050.</p> <p>A: PL02 B: C: INSPECT PREFLIGHT AND POST-FLIGHT. TEST POINT AS IDENTIFIED IN FIGURE L0600000.060.</p>

EXAMINER

26-34

REQUIREMENT					
NUMBER	REV	DESCRIPTION	MEAS/STIMU	SPECIFICATION	INTERVALS/CONSTRAINTS/REMARKS
L33A0000.022	ML043M ML0849	VFY FEC SIG FEEDTHRU PLATE LEAKAGE		0.074 MBAR L/SEC AIR MAX.	A: PLMF2-90;C B: MANDATORY FOR FIRST FLIGHT OF ARTICLE AND CONTINGENCY THEREAFTER. CONTINGENCY IS SEALS WHICH HAVE BEEN DISTURBED OR PREVIOUS MISSION LEAKAGE EXCEEDS ALLOWABLE LIMITS. C: MAX EXTERNAL PRESSURE AT TEST START = 0.13 MILLIBARS. RECORD MEASURED LEAKAGES AND PROVIDE TO MDTSO-HUNTSVILLE.
L33A0000.023	ML0434M ML0849	VFY FEC UP FEEDTHRU PLATE LEAKAGE		0.43 MBAR L/SEC AIR MAX.	A: PLMF2-90 B: C: ALL VALVES IN LAUNCH CONFIGURATION. INCLUDES VALVES INTERNAL PLUS O-RINGS LEAKAGE.  MAX EXTERNAL PRESSURE AT TEST START = 0.13 MILLIBARS. RECORD MEASURED LEAKAGES AND PROVIDE TO MDTSO-HUNTSVILLE.
L33A0000.025	ML0434M ML0849	VFY FEC O2N2 FEEDTHRU LEAKAGE			A: PLMF2-90;C B: MANDATORY FOR FIRST FLIGHT OF ARTICLE AND CONTINGENCY THEREAFTER. CONTINGENCY IS SEALS WHICH HAVE BEEN DISTURBED OR PREVIOUS MISSION LEAKAGE EXCEEDS ALLOWABLE LIMITS. C: MAX EXTERNAL PRESSURE AT TEST START = 0.13 MILLIBARS. RECORD MEASURED LEAKAGES AND PROVIDE TO MDTSO-HUNTSVILLE.
		1. GN2 LINE FEEDTHRU		0.0034 MBAR L/SEC AIR MAX.	1. GN2 LINE CAPPED.
		2. GO2 LINE FEEDTHRU		0.0034 MBAR L/SEC AIR MAX.	2. GO2 LINE CAPPED.
L33F0000.020		VFY GASK-O-SEAL LEAK TST PORTS CAPPED			A: PLM;C

EXAMINER

2.6 - 35

2.6 - 36

REQUIREMENT				
NUMBER	REV	DESCRIPTION	MEAS/STIMU	SPECIFICATION
	ML0091M			B: CONTINGENCY IS CAPS REMOVED/LOOSENED TO PERFORM LEAK TEST.
	ML0434M			C: VISUAL INSPECTION.
	ML0849			A: PLMF2-90
L33H00L4.012	ML0434M	MEAS. WT. & CG OF EACH INTEG EXP RACK		B: RECORD HARDWARE STATUS OF RACK BEFORE CG MEASUREMENT. DUCT CAPS & HORN CAPS SHALL BE REMOVED WHEN WEIGHT & CG IS MEASURED. IDENTIFY ALL IN STALLED NON FLIGHT ITEMS AND/OR MISSION FLIGHT ITEMS AT TIME OF ACTUAL MEASUREMENT. GENERATE AND MAINTAIN A WEIGHT AND CG HISTORY LOG BOOK ON EACH RACK AND RECORD WEIGHT AND CG MEASUREMENTS WITH SUBSEQUENT ENTRIES MADE EACH TIME AN ITEM IS ADDED OR REMOVED.
		WEIGHT MEASUREMENT ACCURACY		+/- 0.3% OR 4.4 LBS. WHICHEVER IS GREATER
		CG MEASUREMENT ACCURACY		
		WEIGHT RANGE LESS THAN OR EQUAL TO 400 LBS. GREATER THAN 400 LBS.		+/- 0.10 INCH ON ALL THREE AXIS +/- 0.5 INCH ON ALL THREE AXIS
L33J0000.010	ML0091M	VERIFY MODULE SUBFLOOR HONEYCOMB PANELS		A: PLM
	ML0434M	FREE OF DENTS OR GOUGES EXCEEDING CRITERIA LIMIT		B:
		1. GOUGES		C: .015 IN. DEEP (.381 MM DEEP) 1.00 IN. LONG (25.4 MM LONG) .03 IN. DEEP
		2. DENTS		

EXAMINABLE

REQUIREMENT		DESCRIPTION	MEAS/STIMU	SPECIFICATION	INTERVALS/CONSTRAINTS/REMARKS
NUMBER	REV				

(.762 MM DEEP)  
.50 IN. DIAMETER  
(12.7 MM DIA.)

**EXAMPLE**



REQUIREMENT					
NUMBER	REV	DESCRIPTION	MEAS/STIMU	SPECIFICATION	INTERVALS/CONSTRAINTS/REMARKS
L60A0000.010	ML0114M ML0768M	VFY ATM PRESS CTRL MANUAL S/O VLV(1409)			A: PLM;C B: MANDATORY FOR SL-1 AND CONTINGENCY THEREAFTER. CONTINGENCY IS FLIGHT OR FUNCTIONAL TEST ANOMALY. C: CHECK FOR BOTH VALVES 1409/1 AND 1409/2. DIFFERENTIAL PRESSURE AT 16.9 +/- 3.1 BAR.
		INTERNAL LEAKAGE		2.0 SCCM MAX.	
L60A0000.020	ML0114M ML0768M	VFY ATM PRESS CTRL GO2 S/O VLV (1410)			A: PLM;C B: MANDATORY FOR SL-1 AND CONTINGENCY THEREAFTER. CONTINGENCY IS FLIGHT OR FUNCTIONAL TEST ANOMALY. C: DIFFERENTIAL PRESSURE AT 7.76 +/- 0.86 BAR
				2.0 SCCM MAX.	
L60A0000.030	ML0114M ML0768M	VERIFY GN2 RELIEF VALVE (1303)			A: PLM;C B: MANDATORY FOR SL-1 AND CONTINGENCY THEREAFTER. CONTINGENCY IS FLIGHT OR FUNCTIONAL TEST ANOMALY. C: CHECK FOR BOTH VALVES 1303/1 AND 1303/2. DIFFERENTIAL PRESSURE 14.8 +/- 1.03 BAR.
		INTERNAL LEAKAGE		2.0 SCCM MAX.	
L60A0000.160	ML0114M ML0769M ML1109A	VERIFY GN2 PRESSURE SENSOR (1305)			A: PLM;C B: MANDATORY FOR FIRST ASSEMBLY AND CONTINGENCY THEREAFTER. CONTINGENCY IS LRU REPLACEMENT.
		GN2 PRESSURE FUNCTIONAL CAL	L02P0103C	+/- 3%	C: CHECK A MINIMUM OF THREE POINTS WITHIN MEASUREMENT RANGE 0 - 20.7 BAR ABSOLUTE. RECORD VALUES.
L60A0000.162	ML0899M	GN2 PRESS (1305) FUNCTIONAL CHECK			A: PLMF2-90 B:

EXAMINABLE

2.6 - 38

REQUIREMENT					
NUMBER	REV	DESCRIPTION	MEAS/STIMU	SPECIFICATION	INTERVALS/CONSTRAINTS/REMARKS
L60A0000.170	ML0114M ML0769M ML1109A	VERIFY CABIN PRESSURE SENSOR (1408)	L02P0143C	GSE +/- .62 BAR	C: ONE POINT CHECK. MAX PRESS 20.7 BAR.
		ATM PRESSURE FUNCTIONAL CAL	L02P0146C	+/- 3%	A: PLM;C B: MANDATORY FOR FIRST ASSEMBLY AND CONTINGENCY THEREAFTER. CONTINGENCY IS LRU REPLACEMENT.
					C: CHECK A MINIMUM OF THREE POINTS WITHIN MEASUREMENT RANGE 0 - 1.38 BAR ABSOLUTE. RECORD VALUES.
L60A0000.180	ML0114M ML0769M ML1109A	VERIFY CABIN PRESSURE SENSOR (3402)			A: PLM;C
		FUNCTIONAL CALIBRATION			B: MANDATORY FOR FIRST ASSEMBLY AND CONTINGENCY THEREAFTER. CONTINGENCY IS LRU REPLACEMENT.
		1. TOTAL PRESSURE	L02P0731C	+/- 3%	C: CHECK A MINIMUM OF THREE POINTS WITHIN MEASUREMENT RANGE 0 - 1.38 BAR ABSOLUTE. RECORD VALUES.
		2. TOTAL PRESSURE	L02P0731V	+/- 3%	
L60A0000.182	ML0899M	CABIN PRESS SENSOR FUNCTIONAL CHECK			A PLMF2-90
		1. TOTAL PRESS (3402)	L02P0731C	AMBIENT +/-31.6MBAR	B: C:
			L02P0731V	AMBIENT +/-31.6MBAR	
		2. ATM PRESS (1408)	L02P0146C	AMBIENT +/-31.6MBAR	
L60A0000.190	ML0114M ML0769M ML1109A	VERIFY GN2 FLOW SENSOR (1400)			A: PLM;C
		FUNCTIONAL CALIBRATION			B: MANDATORY FOR FIRST ASSEMBLY AND CONTINGENCY THEREAFTER. CONTINGENCY IS LRU REPLACEMENT.
		1. GN2 FLOW RATE	L02R0104C	+/- 3%	C: CHECK A MINIMUM OF THREE POINTS WITHIN MEASUREMENT RANGE 0 - 2.27 KG/HR. RECORD VALUES.
		2. GN2 FLOW RATE	L02R0104V	+/- 3%	

2.6 - 39

EXAMINABLE

REQUIREMENT					
NUMBER	REV	DESCRIPTION	MEAS/STIMU	SPECIFICATION	INTERVALS/CONSTRAINTS/REMARKS
L60A0000.192	ML0899M	GN2 FLOW (1404) FUNCTIONAL CHECK			A: PLMF2-90 B: C:
		1. ZERO FLOW CHECK	L02R0104C	0.0 +/- 0.07 KG/HR	1. PANEL LOCKED UP.
		2. FLOW INDICATION CHECK	L02R0104C	FLOW INCREASE	2. ACTIVATE N2 FLOW.
L60A0000.200	ML0114M ML0769M ML1109A	VERIFY GO2 FLOW SENSOR (1406) FUNCTIONAL CALIBRATION			A: PLM;C B: MANDATORY FOR FIRST ASSEMBLY AND CONTINGENCY THEREAFTER. CONTINGENCY IS LRU REPLACEMENT. C: CHECK A MINIMUM OF THREE POINTS WITHIN MEASUREMENT RANGE 0 - 2.27 KG/HR. RECORD VALUES.
		1. GO2 FLOW RATE	L02R0122C	+/- 3%	
		2. GO2 FLOW RATE	L02R0122V	+/- 3%	
L60A0000.202	ML0899A	GO2 FLOW (1406) FUNCTIONAL CHECK			A: PLMF2-90 C:.
		1. ZERO FLOW CHECK	L02R0122C	0.0 +/- 0.07 KG/HR	1. PANEL LOCKED UP.
		2. FLOW INDICATION CHECK	L02R0122C	FLOW INCREASE	2. ACTIVATE O2 FLOW SENSING, USING GN2.
L60A0000.210	ML0114M ML0769M	VERIFY GN2 HI PRESS LTCH VLV			A: PLM B: C: CHECK EOR BOTH INDICATORS 1306/1 AND 1306/2
		1. GN2 VALVE (1301/1) STATUS	L02X0105X	CLOSED	1. COMMAND VALVE 1301/1 CLOSED
		2. GN2 VALVE (1301/1) STATUS	L02X0105X	NOT CLOSED	2. COMMAND VALVE 1301/1 OPEN
		3. GN2 VALVE (1301/2) STATUS	L02X0108X	CLOSED	3. COMMAND VALVE 1301/2 CLOSED
		4. GN2 VALVE (1301/2) STATUS	L02X0108X	NOT CLOSED	4. COMMAND VALVE 1301/2 OPEN
L60A0000.220	ML0114M	VERIFY GN2 HI PRESS REGULATOR (1302)			A: PLM B:

REQUIREMENT					
NUMBER	REV	DESCRIPTION	MEAS/STIMU	SPECIFICATION	INTERVALS/CONSTRAINTS/REMARKS
	ML0769M				C: CHECK FOR BOTH REGULATORS 1302/1 AND 1302/2. INLET PRESSURE WITHIN 20.7 TO 228 BAR ABS.
		1. GN2 REGULATED PRESSURE	L02P0193C	14.8 +/- 1.65 BAR ABS.	
		2. GN2 REGULATOR LOCK UP PRESS	L02P0103C	18.21 BAR ABS. MAX	
L60A0000.230	ML0114M ML0769M	VERIFY CABIN PRESSURE REGULATOR (1407 )			A: PLM B: C: CHECK FOR BOTH VALVES 1407/1 AND 1407/2. INLET PRESSURE WITHIN 6.9 TO 20.0 BAR ABS.
		1. REGULATED PRESSURE		1. 013 +/- 0. 013 BAR ABS.	
		2. LOCK UP PRESSURE		1. 034 BAR ABS. MAX.	
L60A0000.240	ML0114M ML0769M	VERIFY AIRLOCK SUPPLY PRESS REG (1702) FUNCTIONAL CALIBRATION			A: PLM B: C: MISSION WHICH INCLUDE AN AIRLOCK. INLET PRESSURE WITHIN 13.77 TO 20.0 BAR ABS.
		1. REGULATED PRESSURE		1. 013 +/- 0.013 BAR ABS	
		2. LOCK UP PRESSURE		1. 034 BAR ABS. MAX.	
L60J0000.010	ML0116A ML0772M ML0986	VERIFY COND STORAGE ASSEM (2500) LEAK  WATER SIDE LEAK CHECK			A: PLM B: C: MAXIMUM OPERATING PRESSURE 4.1 BAR ABS.  NO WATER VISIBLE

2.6 - 41

REPLACED

REQUIREMENT					
NUMBER	REV	DESCRIPTION	MEAS/STIMU	SPECIFICATION	INTERVALS/CONSTRAINTS/REMARKS
L60J0000.015		VERIFY COND STORAGE ASSY (2500) LEAK			A: PLM B: C: AIR SIDE TO WATER SIDE. TEST AT 1.0 +/- 0.1 BAR (GAGE) N2.
	ML0116A ML0772M				
		BLADDER INTERNAL LEAK CHECK		4 SCC/HR (MAX)	
L60J0000.021		VERIFY COND STORAGE ASSY PRESS SENSOR			A: PLMF2-90 B: C: VERIFY AT AMBIENT.
	ML0924A				
		CONDENSATE PRESSURE	L02P9421C	GSE INDICATION +/- 0.15 BAR	
L60J0000.035		PERFORM CSA GAS ADAPTER PL MAINT			A: PLMF2-90 B: C: EVERY FLIGHT. REF: MA-EN-4001
	ML0994A				
		FILTER		CLEAN OR REPLACE	
L60J0000.040		H2O CONDENSATE STORAGE ASSY DRAIN			A: PL03 B: C: POSTFLIGHT. EXPEL AND WEIGH CONDENSATE DURING TANK DESERVICING AT KSC.
	ML1172A			RECORD	
		CONDENSATE WEIGHT			
L60K0000.010		VERIFY COND DUMP NOZ TEMP SENS (2605)			A: PLM B: C: TURN HEATER CONTROLLER 1 AND 2 ON
	ML0116A ML0610 ML0772M ML0924A				
				SENSORS TO AGREE WITHIN 3 DEG C OF EACH OTHER	
		1. COND DUMP NOZZLE TEMP 1 2. COND DUMP NOZZLE TEMP 2	L02T0445C L02T0446C		
L60K0000.020		VERIFY COND DUMP TEMP CONTROL (2606)			A: PLM B:
	ML0116A				

EXAMINED

REQUIREMENT					
NUMBER	REV	DESCRIPTION	MEAS/STIMU	SPECIFICATION	INTERVALS/CONSTRAINTS/REMARKS
	ML0772M	1. VLV 2601/CONTR 2606-1 CB ST	L02X0436X	ON	C: CONDENSATE DUMP NOZZLE CLOSED.
		2. VLV 2601/CONTR 2606-2 CB ST	L02X0437X	ON	
		3. TEMP CONTROLLER 2606-1			3. ACTIVATE SWITCH ON ECS/ECLS MCP
		1. CONTROLLER 2606-1 STATUS	L02X0441X	ON	HTR CONTROLLER 1 ON
		2. CONTROLLER 2606-1 STATUS	L02X0443X	OFF	HTR CONTROLLER 2 OFF
		3. COND DUMP NOZZLE TEMP 1	L02T0445C	57 TO 73 DEG C	CHECK AUTO CYCLE OF HEATER
		4. TEMP CONTROLLER 2606-2			4. ACTIVATE SWITCH ON ECS/ECLS MCP
		1. CONTROLLER 2606-2 STATUS	L02X0441X	OFF	HTR CONTROLLER 1 OFF
		2. CONTROLLER 2606-2 STATUS	L02X0443X	ON	HTR CONTROLLER 2 ON
		3. COND DUMP NOZZLE TEMP 2	L02T0446C	57 TO 73 DEG C	CHECK AUTO CYCLE OF HEATER
L60K0000.030		VERIFY COND DUMP VALVE (2601) OPEN			A: PLM
	ML0116A				B:
	ML0772M				C: HEATER CONTROLLERS 1 AND 2 OFF.
		1. DUMP VALVE 1 OPEN (MCP)			
		1. COND DUMP VLV 2601 REL 1 ST	L02X0431X	ON	
		2. COND DUMP VLV 2601 REL 2 ST	L02X0433X	OFF	
		3. COND DUMP VLV 2601 STATUS	L02X0435X	OPEN	
		2. DUMP VALVE 1 CLOSE (MCP)			
		1. COND DUMP VLV 2601 REL 1 ST	L02X0431X	OFF	
		2. COND DUMP VLV 2601 STATUS	L02X0435X	CLOSED	
		3. DUMP VALVE 1 CLOSE (KYBD CMD)			
		1. CONDENS DUMP VLVE 2601 CLOSE 1	L02K0433X	EVENT	
		2. COND DUMP VLV 2601 STATUS	L02X0435X	CLOSED	3.2 EVENT ON
		4. DUMP VALVE 2 OPEN (MCP)			
		1. COND DUMP VLV 2601 REL 1 ST	L02X0431X	OFF	
		2. COND DUMP VLV 2601 REL 2 ST	L02X0433X	ON	

2.6 - 43

REQUIREMENT					
NUMBER	REV	DESCRIPTION	MEAS/STIMU	SPECIFICATION	INTERVALS/CONSTRAINTS/REMARKS
		3. COND DUMP VLV 2601 STATUS	L02X0435X	OPEN	
		5. DUMP VALVE 2 CLOSE (MCP)			
		1. COND DUMP VLV 2601 REL 2 ST	L02X0433X	OFF	
		2. COND DUMP VLV 2601 STATUS	L02X0435X	CLOSED	
		6. DUMP VALVE 2 CLOSE (KYBD CMD)			
		1. CONDENS DUMP VLV 2601 CLOSE 2	L02K0434X	EVENT	
		2. COND DUMP VLV 2601 STATUS	L02X0435X	CLOSED	6.2 EVENT ON
L60N0000.010		VERIFY NET WEIGHT OF HALON			A: PLM
	ML0144M				B:
	ML0569	RACK-MOUNTED FSS BOTTLES (EACH)		1515 GRAMS	C: WITHIN 24 MONTHS OF FLIGHT
		FLOOR-MOUNTED FSS BOTTLES (EACH)		1515 GRAMS	
				(+27/-100 GRAMS)	
				(+27/-100 GRAMS)	
L60N0000.015		VERIFY FSS BOTTLE BOND			A: PLM
	ML0144M			2.5 MILLION OHM MAX	B:
	ML0569				C: SHALL APPLY TO KSC INSTALLED EQUIPMENT ONLY WHEN REMOVED OR REPLACED.
L60N0000.020		VERIFY LOAD RESISTANCE OF PYCB			A: PLM
	ML0144M				B: MANDATORY FOR FIRST ASSEMBLY.
	ML0569				C: USE ORDNANCE APPROVED OHM-METER. DO NOT EXCEED NO FIRE MAXIMUM OF 1 AMP AND 1 WATT THROUGH BRIDGE-WIRE FOR 5 MIN. DURING TESTING. SPACELAB POWER OFF.
	ML1051M				
					CAUTION: WHEN FSS BOTTLES ARE DISCONNECTED FROM THE FIRING CIRCUIT WIRING, CAP THE INITIATOR WIRING WITH SHORTING PLUGS OR FARADAY CAPS.

2.6 - 44

REQUIREMENT				
NUMBER	REV	DESCRIPTION	MEAS/STIMU	SPECIFICATION
		RESISTANCE OF INITIATOR AND REDUNDANT HARNESS FROM PYRO CONTROL BOX TO EACH FSS BOTTLE.		0.95 TO 1.7 OHM
L60N0000.021	ML1051M	VERIFY RESISTANCE OF FSS INITIATOR		
		RESISTANCE OF INITIATOR AND REDUNDANT HARNESS FROM RACK/SUBFLOOR INTERFACE TO EACH FSS BOTTLE.		0.95 TO 1.3 OHM
L60N0000.025	ML0144M ML0310 ML0559 KL1025	VERIFY FSS ORDINANCE CIRCUIT CONDITION		
		1. STRAY VOLTAGE AT FIRING CIRCUIT CONNECTOR.		SHALL NOT EXCEED 0.05 VAC (RMS) BETWEEN LINE AND GROUND WHEN LOADED WITH 1 OHM.
		2. STRAY VOLTAGE AT FIRING CIRCUIT CONNECTOR.		SHALL NOT EXCEED 0.05 VAC (RMS) AND 0.05 VDC.

A: PLM  
 B:  
 C: USE ORDINANCE APPROVED OHM-METER. DO NOT EXCEED NO FIRE MAXIMUM OF 1 AMP AND 1 WATT THROUGH BRIDGE-WIRE FOR 5 MIN. DURING TESTING.

SPACELAB POWER OFF.

CAUTION: WHEN FSS BOTTLES ARE DISCONNECTED FROM THE FIRING CIRCUIT WIRING, CAP THE INITIATOR WIRING WITH SHORTING PLUGS OR FARADAY CAPS. PERFORM FOR BOTH THE PRIMARY AND REDUNDANT PATHS.

A: PLM  
 B:  
 C: PERFORM THIS TEST PRIOR TO EACH CONNECTION OF INITIATORS TO FIRING CIRCUIT. EMERGENCY BUSES A AND B ON.

PYRO CONTROL BOX ON "AGENT DISCHARGE" SWITCH IN ARM POSITION.

PYRO CONTROL BOX OFF "AGENT DISCHARGE" SWITCHES IN SAFE POSITION

EXAMINER

2.6 - 45



REQUIREMENT					
NUMBER	REV	DESCRIPTION	MEAS/STIMU	SPECIFICATION	INTERVALS/CONSTRAINTS/REMARKS
L60N0000.028	ML0144M ML0569  KL1026M	VERIFY FIRING CURRENT TO EA FSS INITIATOR FROM PYRO CONTROL BOX		3.5 AMPS MINIMUM FOR 4 MS MIN.	A: PLM B: C:
L60N0000.031	ML0569	VFY PYCB/R-7 PNL W/ F ARM DISC CMDS			A: PLMF 2-90 B: C: SIMULATED OR FLIGHT R-7 PANEL. SIMULATED FSS BOTTLE DISCHARGE SHALL BE MONITORED BY GSE. EMERGENCY BUSES A & B ON. CAUTION: WHEN FSS BOTTLES ARE DISCONNECTED FROM THE FIRING CIRCUIT WIRING, CAP THE INITIATOR WIRING WITH SHORTING PLUGS OR FARADAY CAPS.
		1. FSS "ARM" CMD R-7 PANEL ARM INDICATION SL CW/FSS PANEL ARM INDICATION CABIN FAN 1 LEFT RACKS, RIGHT RACKS, AND SUBFLOOR FSS BOTTLE STATUS	L02K0030E L02X0030E L02X0020E  L02X0301Y	ARM ON ON  OFF NOT DISCHARGED	1. INITIATE TEST WITH CABIN FAN 1 ON.
		2. FSS "ARM" CMD FSS LEFT "AGENT DISCHARGE" CMD LEFT RACKS FSS BOTTLES STATUS RIGHT RACKS, SUBFLOOR FSS BOTTLES STATUS	L02K0030E L02K0031E	ARM ON  DISCHARGED  NOT DISCHARGED	
		3. FSS "ARM" CMD FSS RIGHT "AGENT DISCHARGE" CMD	L02K0030E L02K0033E	ARM ON	

EXAMINABLE

2.6 - 46

REQUIREMENT					
NUMBER	REV	DESCRIPTION	MEAS/STIMU	SPECIFICATION	INTERVALS/CONSTRAINTS/REMARKS
		RIGHT RACK FSS BOTTLES STATUS		DISCHARGED	
		LEFT RACK, SUBFLOOR FSS BOTTLES STATUS		NOT DISCHARGED	
4.		FSS "ARM" CMD	L02K0030E	ARM	
		FSS SUBFLOOR "AGENT DISCHARGE" CMD	L02K0032E	ON	
		SUBFLOOR FSS BOTTLES STATUS		DISCHARGED	
		LEFT RACKS, RIGHT RACKS BOTTLES STATUS		NOT DISCHARGED	
5.		FSS SIMULTANEOUS DISCHARGE			5. LEFT, RIGHT, SUBFLOOR "AGENT DISCHARGE" ON SIMULTANEOUSLY.
		FSS "ARM" CMD	L02K0030E	ARM	
		"DISCHARGE LEFT" CMD	L02K0031E	ON	
		"DISCHARGE RIGHT" CMD	L02K0033E	ON	
		"DISCHARGE SUBFLOOR" SWITCH CMD	L02K0032E	ON	
		LEFT RACK FSS BOTTLES STATUS		DISCHARGE	
		RIGHT RACK FSS BOTTLES STATUS		DISCHARGE	
		SUBFLOOR FSS BOTTLES STATUS		DISCHARGE	
6.		FSS "ARM" CMD	L02K0034E	SAFE	6. LEFT, RIGHT, SUBFLOOR "AGENT DISCHARGE" ON SIMULTANEOUSLY.
		"DISCHARGE LEFT" CMD	L02K0031E	ON	
		"DISCHARGE RIGHT" CMD	L02K0033E	ON	
		"DISCHARGE SUBFLOOR" CMD	L02K0032E	ON	
		R-7 PANEL ARM INDICATION	L02K0030E	OFF	
		SL CW/FSS PANEL INDICATION	L02K0020E	OFF	
		SL CW/FSS PANEL INDICATION	L02K0020E	OFF	
		LEFT RACKS, RIGHT RACKS, SUBFLOOR BOTTLES STATUS		NOT DISCHARGED	
L60Q0000.055		VFY AVIONICS LOOP ON-ORBIT OPERATION			A: PL03 B:
	ML0763M				

2.6 - 47

REQUIREMENT		DESCRIPTION	MEAS/STIMU	SPECIFICATION	INTERVALS/CONSTRAINTS/REMARKS
NUMBER	REV				

ML1075

C: PERFORM AFTER ASCENT/DESCENT VALVE ADJUSTMENT. AVIONICS LOOP IN FINAL FLIGHT CONFIGURATION. FAN IN HIGH SPEED MODE. CLOSE SHUT-OFF VALVES NOT LISTED. MAXIMIZE FLOW AND MINIMIZE PRESSURE LOSS BY SETTING THE SOV FULL OPEN FOR RACK 11. RACK 2-CCR SHUT-OFF VALVE IN ON-ORBIT STOP (INTERMEDIATE) POSITION. RACKS 5 AND 7 (AFT) ARE NOT ADJUSTED AFTER FINAL ASCENT/DESCENT ADJUSTMENT. ADJUSTMENT OF RACK 7 (FWD) TO ACHIEVE THE SPECIFIED ON-ORBIT WILL REQUIRE REVERIFICATION OF ASCENT/DESCENT FLOWS (L60Q0000.060). USE DATA FOR SL-3 DEVELOPED IN L60Q00L4.010, AND VERIFY FLOW RATE INDICATED FOR EACH RACK. IF OTHER RACK SHUT-OFF VALVE STOP ADJUSTMENT IS NECESSARY CLOSE VALVE AND ESTABLISH FLOW IN "OPENING" DIRECTION. DISTRIBUTE EXCESS FLOW AS EVENLY AS PRACTICAL BETWEEN RACKS BY ADJUSTMENT OF THE SOVS DESIGNATED AS ADJUSTABLE FOR THE REQUIREMENT.

PERFORM FOR BOTH FAN1 AND FAN2. RECORD FLOW RATES AND FAN DELTA P.

EXAMPLE

	KG/HR (MIN)
1. RACK 1 - WBR	55
2. RACK 2 - CCR (IMD STOP)	150
3. RACK 3 (FWD)	27.2
4. RACK 3 (AFT)	36
5. RACK 4	55
6. RACK 5	35.6
7. RACK 7 (FWD)	42

REQUIREMENT				
NUMBER	REV	DESCRIPTION	MEAS/STIMU	SPECIFICATION

8.		RACK 7 (AFT)		35.6
9.		RACK 8 (FWD)		71.7
10		RACK 8 (AFT)		71.4
11.		RACK 10 (FWD)		70
12.		RACK 10 (AFT)		31
13.		RACK 11		64.7
14.		RACK 12		36

L60Q0000.060

ML0763M  
ML1075

VFY AVN LOOP ASC/DESC OPERATION

A: PL03

B:  
C: PERFORM PRIOR TO ON-ORBIT VALVE ADJUSTMENT. AVIONICS LOOP IN FINAL FLIGHT ASCENT/DESCENT CONFIGURATION. ASCENT/DESCENT SUPPLY VALVES AND UNDERFLOOR INLET STUB FULLY OPEN. FAN IN LOW SPEED MODE. CLOSE SHUTOFF VALVES FOR ALL RACKS EXCEPT 2,3 (FWD), 3 (AFT), 5,7 (FWD), AND 7 (AFT).

USE DATA FOR SL-3 DEVELOPED IN L60Q00L4.010, AND VERIFY FLOW RATE FOR EACH RACK. RACK 2 (CCR) SHUTOFF VALVE IN ASC/DESC STOP (MIN) POSITION IF NECESSARY, BY ADJUSTING IN CLOSED DIRECTION ONLY. DISTRIBUTE EXCESS FLOW AS EVENLY AS PRACTICAL BETWEEN RACKS BY ADJUSTMENT OF THE SOVS DESIGNATED AS ADJUSTABLE FOR THE REQUIREMENT.

PERFORM FOR BOTH FAN 1 AND FAN 2. RECORD DELTA P FOR FANS. RECORD RACK FLOW RATES.

		KG/HR (MIN)
1.	RACK 1	34
2.	RACK 2 (MIN. STOP)	50
3.	RACK 3 (FWD)	19.6
4.	RACK 3 (AFT)	28.4
5.	RACK 5	35.6

EXAMINABLE

REQUIREMENT		DESCRIPTION	MEAS/STIMU	SPECIFICATION	INTERVALS/CONSTRAINTS/REMARKS
NUMBER	REV				
		6. RACK 7 (FWD)		27.5	
		7. RACK 7 (AFT)		35.6	
L60Q0000.065		VFY AVN LOOP MODULE ENTRY			A: PL03
	ML0763M	(TV COVERAGE)			B:
	ML1075				C: AVIONICS LOOP IN FINAL FLIGHT ASCENT/ DESCENT CONFIGURATION. ASCENT DESCENT SUPPLY VALVES AND UNDERFLOOR INLET STUB FULLY OPEN. FAN IN HIGH SPEED MODE. RACK 2 (CCR) SHUTOFF VALVE IN ASC/DESC STOP (MIN) POSITION. CLOSE SHUTOFF VALVES FOR ALL RACKS EXCEPT 2, 3 (FWD), 3 (AFT), 5,7 (FWD) AND 7 (AFT).
					USE DATA FOR SL-3 DEVELOPED IN L60Q00L4.010 AND VERIFY FLOW RATE INDICTED FOR EACH RACK. DO NOT ADJUST RACK SHUTOFF VALVES.
					PERFORM FOR BOTH FAN 1 AND FAN 2. RECORD FAN DELTA P AND RACK FLOW RATES.
				KG/HR (MIN)	
		1. RACK 1		34	
		2. RACK 2 (MIN STOP)		50	
		3. RACK 3 (FWD)		27.2	
		4. RACK 3 (AFT)		36	
		5. RACK 5		35.6	
		6. RACK 7 (FWD)		27.5	
		7. RACK 7 (AFT)		35.6	

EXAMINABLE

REQUIREMENT					
NUMBER	REV	DESCRIPTION	MEAS/STIMU	SPECIFICATION	INTERVALS/CONSTRAINTS/REMARKS
L63W0000.050	ML0092M ML0260M ML0751	VERIFY WATER LOOP LIQUID CHARGE			A: PLM B: C: PRIOR TO FINAL GSE DISCONNECT. LOOP TEMP STABILIZED.  CAUTION: ACCUMULATOR CONSTRAINTS SHALL BE OBSERVED.  RECORD WATER PUMP ACCUMULATOR QTY (L04Q0105C) AND WATER PUMP INLET AND OUTLET PRESSURES (L04P0101C AND L04P0102C) AT GSE DISCONNECT.
		1. WATER PUMP ACCUM QTY 2. WATER SYSTEM PRESS		24 ± 8% PER FIGURE L63W0000.050	
L63W0000.060	ML0092M ML0514	VERIFY WATER LOOP DISSOLVED GAS		BY VOL (MAX)	A: PLM B: C: VOLUME OF DISSOLVED GAS PER VOLUME OF LIQUID WATER AT 70 DEG F AND 14.7 PSIA.
L63W0000.070	ML0092M ML0428 ML0876 ML1227	VERIFY WATER LOOP DIVERTER VALVE FLIGHT SETTING		DIVERTER SET AT POSITION OF CALIBRATION RANGE	A: PL01,03 PLEOM1 B: C: FLIGHT SETTING TO BE USED FOR ALL SYSTEM FLOW VERIFICATIONS (POSITION CORRESPONDS TO 40 ± 5% BYPASS).
L63W0000.080	ML0092M ML0380 ML0594  ML0751	VERIFY WATER LOOP FLOW RATE			A: PLM B: C: ORBITER PAYLOAD HX SIMUL. DELTA P SET AT 0.19 ± 0.01 BAR. VERIFY FOR BOTH PUMPS 1 AND 2. SYSTEM FILLED TO FLIGHT CHARGE AND DIVERTER VALVE AT FLIGHT

2.6 - 51

REQUIREMENT		DESCRIPTION	MEAS/STIMU	SPECIFICATION	INTERVALS/CONSTRAINTS/REMARKS
NUMBER	REV				
		WATER FLOW RATE		227 ± 7 KG/HR (500 ± 15 LBM/HR)	SETTING IN COLD CASE POSITION. RECORD FLOW RATE WITH DIVERTER VALVE IN COLD CASE AND NORMAL POSITIONS. RECORD FLIGHT SENSOR (L04R0302C/X) OUTPUT. FLOW VERIFICATION VIA GSE WITH FLIGHT SENSOR DATA RECORDED FOR POST TEST ASSESSMENT.
L63W0000.100	ML0092M ML0458M	VERIFY WATER PUMP DELTA P SWITCH			A: PLM B: C: SYSTEM FILLED TO FLIGHT CHARGE.
		1. LOW DELTA PRESS INDICATION		DELTA PRESS OF 0.27	
		2. FLIGHT DELTA PRESS INDICATION		+0 / -0.20 BAR  DELTA PRESS GREATER THAN 0.27 BAR	
L63W0000.105	ML1081	VERIFY WATER PUMP DELTA P ALARM FNC			A: PLMF 2-90 B: C: WATER PUMP DELTA P STATUS ALARM ENABLED. MAY BE ACHIEVED WHEN WATER PUMP TURNED OFF. CAUTION: OBSERVE AVIONICS TEMP LIMIT CONSTRAINTS WHEN PUMP IS OFF.
			L04X0107X L04X0106Y	YES YES	
L63W0000.105	ML1081	VERIFY WATER PUMP PRESS MEASURE CALIB			A: PLM;C B: MANDATORY FOR FIRST ASSEMBLY AND CONTINGENCY THEREAFTER. CONTINGENCY IS INTERFACE DISTURBED. C: FLIGHT PUMPS OFF. STATIC PRESSURE CHECK 3 POINTS MINIMUM FROM 0 TO 8

EXAMINER

2.6 - 52

MSFC-HDBK-2221  
February 1994

REQUIREMENT					
NUMBER	REV	DESCRIPTION	MEAS/STIMU	SPECIFICATION	INTERVALS/CONSTRAINTS/REMARKS
					BAR GAGE.
					CAUTION: ACCUMULATOR CONSTRAINTS SHALL BE OBSERVED.
				GSE INDICATION	
		1. WATER PUMP INLET PRESS	L04P0101C	± 0.5 BAR	
		2. WATER PUMP OUTLET PRESS	L04P0102C	± 0.5 BAR	
L63W0000.112		VERIFY WATER LOOP PRESS MEASUREMENT			A: PLMF 2-90
	ML0748				B: C: FLIGHT PUMPS OFF. STATIC PRESSURE CHECK AT SYSTEM PRESSURE.
					CAUTION: ACCUMULATOR CONSTRAINTS SHALL BE OBSERVED.
				GSE INDICATION	
		1. WATER PUMP INLET PRESS	L04T0101C	± 0.5 BAR	
		2. WATER PUMP OUTLET PRESS	L04T0102C	± 0.5 BAR	
L63W0000.120		VERIFY WATER LOOP TEMP SENSORS			A: PLM
	ML0092M ML0458M				B: C: SYSTEM STABILIZED AT AMBIENT.
		1. WATER PUMP INLET TEMP	L04T0103C	AMBIENT ± 3 DEG C	
		2. INTERL H/X WATER INLET TEMP	L04T0104C	AMBIENT ± 3 DEG C	
		3. AVIONICS H/X WATER OUTLET TEMP	L02T0514C	AMBIENT ± 3 DEG C	
		4. AVIONICS H/X WATER INLET TEMP	L02T0513C	AMBIENT ± 3 DEG C	
		5. WATER OUTLET TEMP (COND H/X)	L02T0334C	AMBIENT ± 3 DEG C	
		6. WATER INLET TEMP (COND H/X)	L02T0333C	AMBIENT ± 3 DEG C	
L63W0000.130		VERIFY WATER LOOP EFFLUENT QUALITY			A: PL01, 03
	ML0092M ML0458M ML0748				B: C: SAMPLE AT ATCS RETURN TO GSE.
		1. PARTICLE SIZE (MICRONS)		MAX COUNT/100 ML	
		UNDER 100		UNLIMITED	
		100-250		93	
		250-300		3	

2.6 - 53



REQUIREMENT					
NUMBER	REV	DESCRIPTION	MEAS/STIMU	SPECIFICATION	INTERVALS/CONSTRAINTS/REMARKS
		OVER 300		0	
		2. PURITY			
		CONDUCTIVITY (MAX)		40 MICRO MHO/CM	
		PH		6.0 TO 8.0	
		TOTAL SOLIDS (MAX)		2.0 MILLIGRM/100 ML	
		CHLORIDES (MAX)		1.0 PPM BY WT	
		HALOCARBONS (MAX)		60 PPM	
		DISSOLVED OXYGEN (MAX)		0.5 PPM BY WT	
		ODOR		NONE DETECTABLE	
L63W0000.140	ML0092M ML0260M ML0458M ML0751	VERIFY WATER LOOP WATER LEAKAGE		NONE VISIBLE	A: PLM B: C: SYSTEM CHARGED AND PRESSURIZED TO 58 ± 2% BELLOWS. DISASSEMBLY OF HARDLINE INSULATION NOT REQUIRED.  CAUTION: ACCUMULATOR CONSTRAINTS SHALL BE OBSERVED.
L63W0000.160		VERIFY WATER PMP REDUCED INLET PRESS PERF		NO AUDIBLE CAVITATION	A: PLM B: C: FILTER FLOW CHECK. PERFORM FOR BOTH PUMPS 1 AND 2. DIVERTER VALVE AT FLIGHT SETTING AND NORMAL. PUMP PACKAGE BYPASS VALVES SET FOR FLIGHT. INLET PRESS MAINTAINED BY GSE AT 1.55 ± 0.07 BAR AT FLOW RATE OF 227 ± 5% KG/HR. MONITOR WITH STETHOSCOPE TO DETERMINE ONSET OF CAVITATION. IF CAVITATION OCCURS, DEACTIVATE PUMP IMMEDIATELY.
L63W0000.172	ML0751	VERIFY WATER LOOP FLUIDS IN LIMIT			A: PLMF 2-90 B: C: MONITOR QUANTITY AND PRESSURE
		1. ACCUMULATOR QTY	L04Q0105A	PER FIGURE	

EXAMINABLE

2.6 - 54

MSFC-HDBK-2221  
February 1994

REQUIREMENT		DESCRIPTION	MEAS/STIMU	SPECIFICATION	INTERVALS/CONSTRAINTS/REMARKS
NUMBER	REV				
				L63W0000.170-1	TRENDS TO DETERMINE ACCEPTABLE FOR LAUNCH.
2.		WATER PUMP INLET PRESS	L04P1101V	PER FIGURE L63W0000.172	<ol style="list-style-type: none"> <li>CHECK AT LEAST DAILY WHENEVER CDMS ACTIVATED.</li> <li>CHECK AT LEAST DAILY WHENEVER SL POWERED UP. PUMP INLET PRESSURE SHALL BE ABOVE APPROPRIATE AMBIENT TEMPERATURE CURVE.</li> </ol>

**EXAMPLE**

REQUIREMENT					
NUMBER	REV	DESCRIPTION	MEAS/STIMU	SPECIFICATION	INTERVALS/CONSTRAINTS/REMARKS
L72A2000.210	ML0053A ML0496M ML1129	VERIFY POWER OFF TIME COUPLER			A: PLA;C B: MANDATORY FOR FIRST ASSEMBLY CONTINGENCY THEREAFTER. CONTINGENCY IS I/F DISTURBED.
		EXIO TIME COUPLER OFF CMD	L03K0266X	ON	
		EXIO TIME COUPLER STATUS	L03X0266X	OFF	
L72A2000.270	ML0496M ML1128	VFY SELECTION OF EXIO RED CPLRS			A: PLAF2-90;C B: MANDATORY FOR FIRST ASSEMBLY CONTINGENCY THEREAFTER. CONTINGENCY IS I/F DISTURBED. C:
		1. EXIO MDM COUPLER B ON CMD	L03K0261X	ON	
		EXIO MDM COUPLER A STATUS	L03X0261X	OFF	
		2. EXIO PCMMU COUPLER B ON CMD	L03K0262X	ON	
		EXIO PCMMU COUPLER A STATUS	L03X0262X	OFF	
		3. EXIO MMU COUPLER B ON CMD	L03K0263X	ON	
		EXIO MMU COUPLER A STATUS	L03X0263X	OFF	
		4. EXIO RAU COUPLER B ON CMD	L03K0264X	ON	
		EXIO RAU COUPLER A STATUS	L03X0264X	OFF	
		5. EXIO DDS COUPLER B ON CMD	L03K0265X	ON	
		EXIO DDS COUPLER A STATUS	L03X0265X	OFF	
L72A2000.305	ML0496M ML1128	VFY I/O A POWER ON/OFF CMD			A: PLAF2-90;C B: MANDATORY FOR FIRST ASSEMBLY CONTINGENCY THEREAFTER. CONTINGENCY IS I/F DISTURBED. C:
		1. EXIO POWER SUPPLY A ON CMD	L03K0251X	ON	
		EXIO POWER SUPPLY A STATUS	L03X0251X	ON	
		2. EXIO POWER SUPPLY (A&B) OFF CMD	L03K0253X	ON	
		EXIO POWER SUPPLY A STATUS	L03X0251X	OFF	
		EXIO POWER SUPPLY B STATUS	L03X0252X	OFF	

2.6 - 56

REQUIREMENT					
NUMBER	REV	DESCRIPTION	MEAS/STIMU	SPECIFICATION	INTERVALS/CONSTRAINTS/REMARKS
L72A2000.315	ML0496M ML1128	VERIFY I/O B POWER ON/OFF CMD			A: PLAF2-90;C B: MANDATORY FOR FIRST ASSEMBLY CONTINGENCY THEREAFTER. CONTINGENCY IS I/F DISTURBED. C:
		1. EXIO POWER SUPPLY B ON CMD EXIO POWER SUPPLY B STATUS	L03K0252X L03X0252X	ON ON	
		2. EXIO POWER SUPPLY (A/B) OFF CMD EXIO POWER SUPPLY A STATUS EXIO POWER SUPPLY B STATUS	L03K0253X L03X0251X L03X0252X	ON OFF OFF	
L72B1000.100	ML0053A ML0496M ML1129	VERIFY SSC POWER ON CMD			A: PLA:C B: MANDATORY FOR FIRST ASSEMBLY CONTINGENCY THEREAFTER. CONTINGENCY IS I/F DISTURBED. C:
		SSC POWER ON, SSIO DMA TO SSC CMD	L03K0101Y	ON	
		SSC POWER STATUS	L03X0101Y	ON	
		SSIO DMA I/O-CU TO SSC	L03X0101Y	ON	
L72B1000.200	ML0053A ML0312M ML0496M ML1129	VERIFY CMD TO ACTIVATE AUTO RESTART			A: PLA;C B: MANDATORY FOR FIRST ASSEMBLY CONTINGENCY THEREAFTER. CONTINGENCY IS I/F DISTURBED. C:
		SSC AUTO RESTART ON CMD	L03K0105Y	ON	
		SSC AUTO RESTART STATUS	L03X0105Y	ON	
		SCOS PIOL SEQUENCE COUNTER	L07M4190P	UPDATING	
L72B1000.300	ML0953A ML0496M ML1129	VERIFY SSC POWER OFF CMD			A: PLA;C B: MANDATORY FOR FIRST ASSEMBLY CONTINGENCY THEREAFTER. CONTINGENCY IS I/F DISTURBED. C:
		SSC PWR OFF, AUTO RESTART OFF CMD	L03K0102Y	ON	
		SSC POWER STATUS	L03X0101Y	OFF	
		SSC AUTO RESTART STATUS	L03X0105Y	OFF	

2.6 - 57

REQUIREMENT					
NUMBER	REV	DESCRIPTION	MEAS/STIMU	SPECIFICATION	INTERVALS/CONSTRAINTS/REMARKS
L72B1000.410	ML0496M ML1128	VFY IPL VIA SSIO MDM CPLRS A & B			A: PLAF2-90;C B: MANDATORY FOR FIRST ASSEMBLY CONTINGENCY THEREAFTER. CONTINGENCY IS I/F DISTURBED. C: SEQUENCE DEPENDENT. LOAD SCOS TO EITHER SSC OR BUC. PERFORM ALL SUB-ITEM STEPS FOR BOTH COUPLERS A & B.
		1. CMD SCOS LOAD VIA MDM		ON	
		2. SCOS PIOL SEQUENCE COUNTER	L07M4190P	UPDATING	2. VERIFY AFTER 5.5 MIN. MAX.
		3. SSIO MDM COUPLER FAIL	L03X0221Y	ON	
		4. SCOS LOAD EXECUTED		OFF	
L72B1000.510	ML0496M ML1128	VFY IPL VIA SSIO MMU CPLRS A & B			A: PLAF2-90;C B: MANDATORY FOR FIRST ASSEMBLY CONTINGENCY THEREAFTER. CONTINGENCY IS I/F DISTURBED. C: SEQUENCE DEPENDENT. LOAD SCOS TO EITHER SSC OR BUC.
		1. SSIO MMU COUPLER FAIL	L03X0223Y	ON	
		2. SSIO DMA/IOCU FAIL	L03X0227Y	ON	
		3. CMD SCOS LOAD VIA MMU		ON	
		4. IPL STATUS WORD E BIT	L07X4153X	NO	4. VERIFY AFTER BOOTSTRAP LOADED.
		IPL STATUS WORD R BIT	L07X4156X	NO	
		IPL STATUS WORD ERROR CODE	L07Q4157C	HOLD	
		IPL BLOCK COUNTER	L07Q4158C	INCREMENTING	
		5. SCOS PIOL SEQUENCE COUNTER	L07M4190P	UPDATING	5. VERIFY AFTER 20 MIN. MAX
		6. SSIO MMU COUPLER FAIL	L03X0223Y	ON	
		7. SCOS LOAD EXECUTED		OFF	
L72B2000.100	ML0053A ML0496M ML1129	VERIFY CMD TO POWER-ON EXC			A: PLA;C B: MANDATORY FOR FIRST ASSEMBLY CONTINGENCY THEREAFTER. CONTINGENCY IS I/F DISTURBED. C:
		EXC POWER ON/DMA TO EXC	L03K0161X	ON	
		CMD			
		EXC POWER STATUS	L03X0161X	ON	
		I/O EXP DMA IO-CU TO EXC	L03X0267X	ON	
L7282000.410	ML0496M ML1128	VFY IPL VIA EXIO MDM CPLRS A & B			A: PLAF2-90;C B: MANDATORY FOR FIRST ASSEMBLY CONTINGENCY THEREAFTER.

26 - 58

REQUIREMENT					
NUMBER	REV	DESCRIPTION	MEAS/STIMU	SPECIFICATION	INTERVALS/CONSTRAINTS/REMARKS
					C: CONTINGENCY IS I/F DISTURBED. SEQUENCE DEPENDENT. LOAD ECOS TO EITHER EXC OR BUC. PERFORM ALL SUB-ITEM STEPS FOR BOTH COUPLERS A & B.
		1. CMD ECOS LOAD VIA MDM		ON	
		2. ECOS PIOL SEQUENCE COUNTER	L07M6190P	UPDATING	
		3. EXIO MDM COUPLER FAIL	L03X0271X	ON	3. VERIFY AFTER 9.0 MIN. MAX.
		4. ECOS LOAD EXECUTED		OFF	
L72B2000.510	ML0496M ML1128	VFY IPL VIA EXIO MMU COUPLRS A & B			A: PLAF2-90;C B: MANDATORY FOR FIRST ASSEMBLY CONTINGENCY THEREAFTER. CONTINGENCY IS I/F DISTURBED. C: SEQUENCE DEPENDENT. LOAD ECOS TO EITHER EXC OR BUC. PERFORM ALL SUB-ITEM STEPS FOR BOTH COUPLERS A & B.
		1. EXIO MMU COUPLER FAIL	L03X0273X	ON	
		2. EXIO DMA/IOCU FAIL	L03X0272X	ON	
		3. CMD ECOS LOAD VIA MMU		ON	
		4. IPL STATUS WORD E BIT	L07X6155X	NO	4. VERIFY AFTER BOOTSTRAP LOADED.
		IPL STATUS WORD R BIT	L07X6156X	NO	
		IPL STATUS WORD ERROR CODE	L07X6157X	H00	
		IPL BLOCK COUNTER	L07X6158X	INCREMENTING	
		5. ECOS PIOL SEQUENCE COUNTER	L07M6190P	UPDATING	5. VERIFY AFTER 20 MIN. MAX.
		6. EXIO MMU COUPLER FAIL	L03X0273X	ON	
		7. ECOS LOAD EXECUTED		OFF	
L72B2000.600	ML0053A ML0496M ML1129	VERIFY CMD TO POWER OFF EXC.			A: PLA;C B: MANDATORY FOR FIRST ASSEMBLY CONTINGENCY THEREAFTER. CONTINGENCY IS I/F DISTURBED. C:
		EXC. POWER OFF CMD	L03K0162X	ON	
		EXC. POWER STATUS	L03X0161X	OFF	
L72B3000.100	ML0053A ML0496M ML1129	VFY BUC PWR ON CMD AS SSC			A: PLA;C B: MANDATORY FOR FIRST ASSEMBLY CONTINGENCY THEREAFTER. CONTINGENCY IS I/F DISTURBED. C:
		BU COMP POWER ON, SSIO DMA TO BU	L03K0131Y	ON	

26 - 59

MSFC-HDBK-2221  
February 1994

REQUIREMENT				
NUMBER	REV	DESCRIPTION	MEAS/STIMU	SPECIFICATION
		COMP CMD		
		BU COMPUTER POWER STATUS	L03X0131Y	ON
		SSIO DMA I/O-CU TO SS COMP	L03X0217Y	OFF

**EXAMPLE**

NUMBER	REV	COMPONENT	CONDITION	CONSTRAINTS
L72BR000.010	ML0137M	REMOTE ACQUISITION UNIT (RAU)	TEMPERATURES	1. THE RAU ENVIRONMENT (MOUNTING PLATE OR AMBIENT AIR) SHALL NOT EXCEED A TEMPERATURE OF 130 DEGREES F.
L72BR000.020	ML0137M	REMOTE ACQUISITION UNIT (RAU)	MONITORING	1. ANYTIME POWER IS APPLIED TO RAU, THE CONTENTS OF THE BITE STATUS WORD SHALL BE MONITORED. MONITORING BY SCOS/ECOS IS ACCEPTABLE.
L72BR000.030	ML0137M	REMOTE ACQUISITION UNIT (RAU)	TEST FAILURE REPORTS	1. RAU TEST FAILURE REPORTS SHALL INCLUDE THE FOLLOWING DATA REQUIREMENTS AS A MINIMUM FOR THE PERIOD IN WHICH THE FAILURE EXISTED: RAU SELF-TEST WORDS ( 10 PER RAU) RAU DEVICE ERROR COUNTER RAU COUPLER STATUS WORDS - INTERRUPT STATUS WORD - ERROR STATUS WORD - PROGRAM STATUS WORD LAST OCCURRENCE ERROR BUFFER IN ECOS OR SINGLE ERROR BUFFER IN SCOS.
L72BR000.040	ML0137M	CDMS	ACTIVATION SEQUENCE	1. THE ACTIVATION SEQUENCE (SELECT I/O COUPLER, POWER ON I/O POWER SUPPLY, POWER ON COMPUTER) IS MANDATORY.
L72BR000.050	ML0137M	I/O UNIT	REDUNDANT COUPLERS SWITCHING	A CHANGE TO THE REDUNDANT COUPLER(S) OF THE I/O UNIT SHALL BE PERFORMED ONLY IF THE I/O AND COMPUTER POWER ARE OFF.
L72BR000.060	ML1126A	HDDRA	FAN DEACTIVATION	REMOVE POWER TO THE FAN BEFORE DEACTIVATING THE INVERTER FEEDING THE FAN.
L72JR000.010	ML0979	HDDR	OPERATION	1. DO NOT REPRODUCE WITH OCTAVE 3 COMMANDED.  NOTE: SHOULD THIS BE ATTEMPTED THE HDDR WILL CONSUME POWER ASSOCIATED WITH THE REPRODUCE ELECTRONICS BUT WILL NOT MOVE TAPE. THE UNIT WILL RESPOND AS IF A MISMATCH EXISTED BETWEEN THE COMMANDED OCTAVE AND REPRODUCE CLOCK.  2. DO NOT REMOVE MAIN SYSTEM POWER DURING EXECUTION OF THE UNLOAD MODE.

2.6 - 61



NUMBER

REV

COMPONENT

CONDITION

CONSTRAINTS

NOTE: SHOULD THIS HAPPEN THE UNIT COULD COAST PAST ONE OF THE POPQUE SPOTS ON TAPE DURING BRAKING ALLOWING TAPE TO MOVE AT THE WRONG SPEED UPON REAPPLICATION OF POWER AND THE NEXT UNLOAD COMMAND. TO RECOVER FROM THIS CONDITION, IT IS RECOMMENDED THAT FOLLOWING THE RESTORATION OF POWER, AN UNLOAD COMMAND FOLLOWED IMMEDIATELY BY A LOAD COMMAND BE APPLIED. THE UNIT SHOULD THEN BE ALLOWED TO COMPLETE THE LOAD MODE, AFTER WHICH UNLOAD MAY BE REENTERED.

3. THE MINIMUM TIME BETWEEN COMMANDS MUST BE GREATER THAN 32 MILLISECONDS TO INSURE RESPONSE TO THE LAST COMMAND.
4. DO NOT COMMAND A POWER OFF WHILE THE TAPE IS IN MOTION.

NOTE: SEVERE DAMAGE TO THE TAPE MAY RESULT DUE TO THE SUDDEN APPLICATION OF BRAKES TO THE TAPE SUPPLY REEL WHILE THE TAPE RECEIVING REEL CONTINUES TO ROTATE. ALTHOUGH THE BRAKE FORCE IS DESIGNED TO BE APPLIED GRADUALLY, THE INERTIA INVOLVED MAY STRETCH THE TAPE, ESPECIALLY AT HIGH SPEEDS. IF THIS SHOULD OCCUR, IT IS RECOMMENDED A RECORDING BE MADE OVER THE SUSPECTED DAMAGED AREA, PLAYED BACK AND THE RESULTING DATA BE EVALUATED FOR ERROR RATE.

5. DO NOT ALLOW HEAD TEMPERATURE TO EXCEED 45 DEG C (113 F).

NOTE: STEPS SHOULD BE TAKEN TO REDUCE TEMPERATURE BY REDUCING RECORD OR REPRODUCE RATE TO CONSUME LESS POWER OR BY LOWERING TEMPERATURE OF COOLING AIR. IF TEMPERATURE REACHES 50 DEG C (122 F) THE RECORDER SHOULD BE PUT IN STANDBY OR TURNED OFF UNTIL VOLTAGE IS BELOW 4.2 V.

6. THE TAPE WILL BE POSITIONED TO CENTER OF TAPE, TO DISTRIBUTE LOADS AND OPTIMIZE TAPE TENSIONING, PRIOR TO LAUNCH USING THE FOLLOWING PROCEDURE:
  - A. POSITION TAPE TO BOT.
  - B. FAST FORWARD TO EOT.

EXAMINER

26 - 62

NUMBER	REV	COMPONENT	CONDITION	CONSTRAINTS
				<p>C. REPRODUCE TO BOT AT 16 MPBS.</p> <p>D. RECORD TO COT (POSITION 120-135) AT 32 MBPS.</p> <p>E. ISSUE "STOP" COMMAND AND REMOVE POWER.</p>
			7.	<p>THE EXTERNAL CLOCK RATE INPUT SHALL BE SET TO 16 MBPS OR LESS PRIOR TO ENTERING SELF TEST MODE.</p>
				<p>NOTE: THIS WILL PREVENT POSSIBLE DAMAGE TO TAPE SHOULD A SELF TEST FAILURE OCCUR. SHOULD AN ERROR OR AN END OF TAPE BE ENCOUNTERED DURING SELF TEST, IT IS NECESSARY TO REMOVE SYSTEM POWER TO MAKE THE HDRR RESPONSIVE TO NEW COMMANDS.</p>
			8.	<p>DO NOT CHANGE EXTERNAL CLOCK RATE WHILE TAPE IS IN MOTION. DAMAGE TO TAPE MAY OCCUR.</p>

**EXAMMPLES**

REQUIREMENT				
NUMBER	REV	DESCRIPTION	MEAS/STIMU	SPECIFICATION
L73C0000.011		VERIFY SMOKE SENSORS		
	ML0762M			
	1.	VIA CDMS		
		1. SMOKE CONCENTRATION S1 (RIGHT B)	L02R0011C	<= 0.3 MG/CU M
		2. SMOKE CONCENTRATION S2 (RIGHT A)	L02R0012C	<= 0.3 MG/CU M
		3. SMOKE CONCENTRATION S3 (SUBFLOOR B)	L02R0013C	<= 0.3 MG/CU M
		4. SMOKE CONCENTRATION S4 (SUBFLOOR A)	L02R0014C	<= 0.3 MG/CU M
		5. SMOKE CONCENTRATION S5 (LEFT B)	L02R0015C	<= 0.3 MG/CU M
		6. SMOKE CONCENTRATION S6 (LEFT A)	L02R0016C	<= 0.3 MG/CU M
	2.	VIA R-7 PANEL		
		SMOKE SENSOR TEST	L02K0001E	TEST
		SMOKE SENSOR 1 INHIBIT	L02K0011E	ENABLE
		SMOKE SENSOR 1 ALARM (RIGHT B)	L02X0011E	FIRE
		SMOKE SENSOR 2 INHIBIT	L02X0011Y	FIRE
		SMOKE SENSOR 2 ALARM (RIGHT A)	L02K0012E	ENABLE
			L02X0012E	FIRE
		SMOKE SENSOR 3 INHIBIT	L02X0012Y	FIRE
		SMOKE SENSOR 3 ALARM (SUBFL B)	L02K0013E	ENABLE
			L02X0013E	FIRE
			L02X0013Y	FIRE

A: PLMF2-90  
 B:  
 C:

1. CDMS POWERED ON SMOKE SENSORS AT AMBIENT CONDITION

2. SIMULATE R-7 PANEL. WAIT APPROXIMATELY 25 SECONDS AFTER R-7 PANEL SMOKE SENSOR SWITCH IS IN "TEST" POSITION.

EXAMINED

2.6 - 64

REQUIREMENT				
NUMBER	REV	DESCRIPTION	MEAS/STIMU	SPECIFICATION
		SMOKE SENSOR 4 INHIBIT	L02K0014E	ENABLE
		SMOKE SENSOR 4 ALARM	L02X0014E	FIRE
		(SUBFL A)	L02X0014Y	FIRE
		SMOKE SENSOR 5 INHIBIT	L02K0015E	ENABLE
		SMOKE SENSOR 5 ALARM	L02X0015E	FIRE
		(LEFT B)	L02X0015Y	FIRE
		SMOKE SENSORS 1,5 ALARM	L02X0001E	
		(A)		MAY BE VERIFIED WITH EITHER SMOKE SENSOR 1,3, OR 5 ALARM ON.
		SMOKE SENSOR 6 INHIBIT	L02K0016E	ENABLE
		SMOKE SENSOR 6 ALARM	L02X0016E	FIRE
		(LEFT A)		
		SMOKE SENSORS 2,4,6 ALARM	L02X0016Y	FIRE
		(A)	L02X0002E	FIRE
		SMOKE SENSOR RESET	L02K0002E	RESET
				ALL SMOKE SENSOR INHIBITS ENABLED AND ALARMS ON.
		ALL SMOKE SENSOR ALARMS		OFF
L73C0000.013		VFY EXP RACK SHUTOFF VLV/PWR STATUS		A: PLMF2-90
	ML0762M			B: INDIVIDUALLY CHECK ALL INSTALLED EPSP'S.
				C: BOTH AC AND DC POWER MUST BE UTILIZED ONCE.
		1. VIA MDM		1. APPLY AC OR DC POWER TO EPSP.
		-VERIFY SHUTOFF VLV/PWR STATUS EXP RACK ALARM		VALVE NOT FULLY OPEN.
			ALARM	VALVE NOT FULLY OPEN.
		-VERIFY SHUTOFF VLV/PWR STATUS EXP RACK ALARM		
			NO ALARM	
		-VERIFY SHUTOFF VLV/PWR STATUS EXP RACK ALARM		
			NO ALARM	COOLING VALVE SIGNAL COMMAND INHIBITED AND VALVE NOT FULLY OPEN.

2.6 - 65

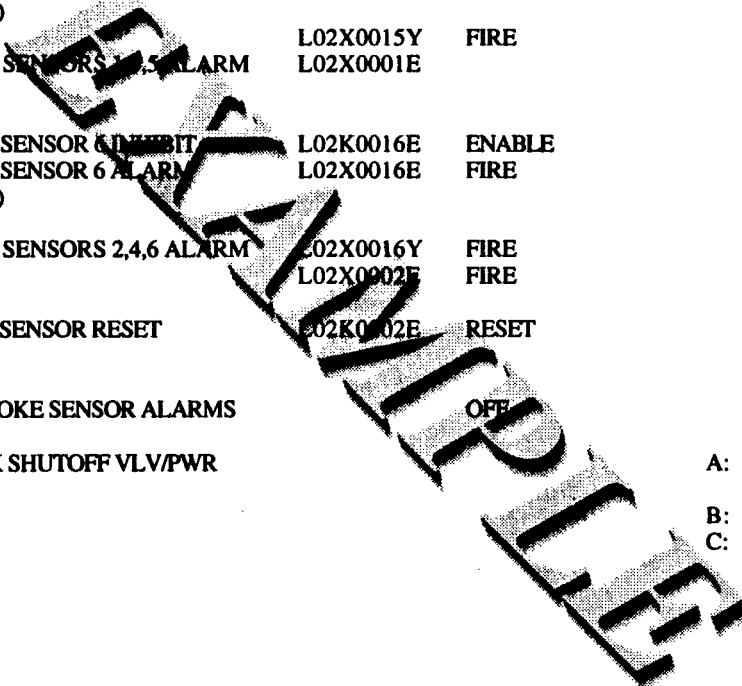

REQUIREMENT					
NUMBER	REV	DESCRIPTION	MEAS/STIMU	SPECIFICATION	INTERVALS/CONSTRAINTS/REMARKS
		2. VIA CDMS			2. APPLY AC OR DC POWER TO EPSP.
		-VERIFY SHUTOFF VLV/PWR STATUS EXP RACK ALARM		ALARM	VALVE NOT FULLY OPEN
		-VERIFY SHUTOFF VLV/PWR STATUS EXP RACK ALARM		NO ALARM	VALVE FULLY OPEN.
L73C0000.041	ML0762M	VERIFY CW/FSS PANEL FUNCTIONS			A: PLMF2-90 B: C:
		1. SIREN TONE	L02X0052E	ALARM	1. SIREN STIMULUS PRESENT.
		2. MASTER ALARM LIGHT	L02X0051E	ALARM	2. MASTER ALARM SIGNAL PRESENT.
L73N1000.011	ML0516M	VERIFY RAAB CONVERTER A			A: PLAF2-90:C B: MANDATORY FOR SL-2. CONTINGENCY HEREAFTER. CONTINGENCY IS IF DISTURBED. C: MAIN BUS ON. 28 VDC NOM.
		RAAB CONV A VERIFICATION OK	L05X0109Y	YES	
L73N1000.021	ML0516M ML1119	VERIFY RAAB CONVERTER B			A: PLAF2-90:C B: MANDATORY FOR FIRST ASSEMBLY, CONTINGENCY THEREAFTER CONTINGENCY IS INTERFACE DISTURBED. C: ESS BUS ON. 28V NOM.
		RAAB CONV B VERIFICATION OK	L05X0110X	YES	
L73N1000.031	ML0516M ML1119				A: PLAF2-90:C B: MANDATORY FOR FIRST ASSEMBLY, CONTINGENCY THEREAFTER. CONTINGENCY IS INTERFACE DISTURBED. C: MAIN & ESS BUSES ON. 28V NOM.
		1. RAAB 28V BUS 1 VOLTAGE	L05V0101C	29 +/- 1.3 VDC	
		2. RAAB 28V BUS 2 VOLTAGE	L05V0102C	29 +/- 1.3 VDC	
		3. RAAB 6V BUS 1 VOLTAGE	L05V0103C	6 +/- 0.4 VDC	
		4. RAAB 6V BUS 2 VOLTAGE	L05V0104C	6 +/- 0.4 VDC	
		5. RAAB 6V BUS 3 VOLTAGE	L05V0105C	6 +/- 0.4 VDC	
		6. RAAB 6V BUS 4 VOLTAGE	L05V0106C	6 +/- 0.4 VDC	

2.6 - 66

REQUIREMENT				
NUMBER	REV	DESCRIPTION	MEAS/STIMU	SPECIFICATION
		7. RAAB +10V BUS VOLTAGE	L05V0107C	10 +/- 0.6 VDC
		8. RAAB -10V BUS VOLTAGE	L05V0108C	-10 +/- 0.6 VDC
L73N1000.040	ML0099M ML0125 ML0660	DELETED		
L73N1000.041	ML0516M ML1119	VERIFY RAAB BUS 1 SEC VOLTAGE		
		RAAB 28V BUS 1 SEC VOLTAGE OK	L05X0101Y	YES
L73N1000.050	ML0099M ML0125 ML0660	DELETED		
L73N1000.051	ML0516M ML1119	VERIFY RAAB BUS 2 SEC VOLTAGE		
		RAAB 28V BUS 2 SEC VOLTAGE OK	L05X0102Y	YES
L73N1000.052	ML0516M ML1119	VERIFY RAAB BITE		
		1. RAAB COMMAND VERIFICATION BITE OK	L05X0111X	NO
		2. RAAB COMMAND VERIFICATION BITE OK	L05X0111X	YES

A: PLAF2-90;C  
 B: MANDATORY FOR FIRST ASSEMBLY, CONTINGENCY THEREAFTER. CONTINGENCY IS INTERFACE DISTURBED.  
 C: MAIN & ESS BUSES ON. 28V NOM.

A: PLAF2-90;C  
 B: MANDATORY FOR FIRST ASSEMBLY, CONTINGENCY THEREAFTER. CONTINGENCY IS INTERFACE DISTURBED.  
 C: MAIN & ESS BUSES ON. 28V NOM.

A: PLAF2-90;C  
 B: MANDATORY FOR FIRST ASSEMBLY, CONTINGENCY THEREAFTER. CONTINGENCY IS INTERFACE DISTURBED.  
 C: MAIN & ESS BUSES ON. 28V NOM.

1. WITH NO COMMANDS THROUGH THE RAAB.

2. REQUIRES COMMANDS TO BE SENT

2.6 - 67

EXAMPLE

REQUIREMENT					
NUMBER	REV	DESCRIPTION	MEAS/STIMU	SPECIFICATION	INTERVALS/CONSTRAINTS/REMARKS
L73N1000.060		VERIFY ECS MASTER PWR OFF COMMAND			THROUGH THE RAAB.
	ML0621				A: PLM;C
	ML0762M				B: VERIFICATION OF ANY ONE MEASUREMENT MANDATORY FOR EACH FLIGHT. VERIFICATION OF ALL MEASUREMENTS MANDATORY FOR FIRST FLIGHT OF EACH MODULE, CONTINGENCY THEREAFTER. CONTINGENCY IS INTERFACE DISTURBED.
		1. ECS MASTER PWR OFF	L02K2051Y	OFF	C: 1. AV FAN 1, CABIN FAN 1, WATER PUMP 1, ROTARY SEPARATOR 1, FREON PUMP 2 ON OR THEIR PWR RELAYS IN ON POSITION.
		AV FAN 1 PWR REL STATUS	L02X031X	OFF	
		CABIN FAN 1 STATUS	L02X0301X	OFF	
		WATER PUMP 1 PWR STATUS	L04X0103Y	OFF	
		ROTARY SEPARATOR 1 RELAY STATUS	L02X0401X	OFF	
		FREON PUMP 2 PWR STATUS	L04X0209Y	OFF	
		2. ECS MASTER PWR OFF	L02K2051Y	OFF	2. AV FAN 2, CABIN FAN 2, WATER PUMP 2, ROTARY SEPARATOR 2, FREON PUMP 1 ON OR THEIR PWR RELAYS IN ON POSITION.
		AV FAN 2 PWR REL STATUS	L02X0504X	OFF	
		CABIN FAN 2 STATUS	L02X0303X	OFF	
		WATER PUMP 2 PWR STATUS	L04X0109Y	OFF	
		ROTARY SEPARATOR 2 RELAY STATUS	L02X0411X	OFF	
		FREON PUMP 1 PWR STATUS	L04X0208Y	OFF	
L73N1000.070		VERIFY ECS MASTER PWR OFF COMMAND			A: PLP
	ML0762M				B:
		ECS MASTER PWR OFF CMD	L02K2051Y	OFF	C:

EXAMINED

2.6 - 68

MSFC-HDBK-2221  
February 1994

REQUIREMENT		DESCRIPTION	MEAS/STIMU	SPECIFICATION	INTERVALS/CONSTRAINTS/REMARKS
NUMBER	REV				
1.		FREON PUMP 1 PWR STATUS	L04X0208Y	OFF	1. FREON PUMP 1 ON OR PWR RELAY IN ON POSITION.
2.		FREON PUMP 2 PWR STATUS	L04X0209Y	OFF	2. FREON PUMP 2 ON OR PWR RELAY IN ON POSITION.

**EXAMPLE**



PACKAGE NO. 10443R

DOCUMENTATION RELEASE LIST  
GEORGE C. MARSHALL SPACE FLIGHT CENTERMSFC CODE IDENT 14981/339B2  
ISSUE DATE FEB 22 2007

PAGE 1

C H	DOCUMENT NUMBER	DRL DRL DSH REV	TITLE	CCBD NO.	PCN	PC	EFFECTIVITY
*	MSFC-HDBK-2221	203 -	VERIFICATION HANDBOOK VOLUMES I AND II	000-00-0000	0000000	ZA	NONE
CHG NO.	CHG REV	CHG NOTICE	RESPONSIBLE ENGINEER	RESPONSIBLE ORGANIZATION	ACTION DATE	DESCRIPTION	
			T. ROWELL	EL45	04/05/94	BASELINE RELEASE	
	1	DCN001	S. FREEMAN	EL45	09/21/94	ADDITION OF VOLUME II TO THE VERIFICATION HANDBOOK.	
*	2	DCN000	EUGENA GOGGANS	EO03	02/22/07	DOCUMENT RELEASED THRU PDS. NO LONGER TRACKED IN ICMS.	

CHECKER

N/A  
02/15/07

(FINAL)

PACKAGE NO: 10443R

PROGRAM/PROJECT: MULTI

LAST UPDATED: 02/22/07

NOMENCLATURE: MSFC-STD- GOING TO NONE EFFECTIVITY

ECR NO:	PCN:	CCBD NO:	DATE PREPARED:
EO03-0000	0000000	000-00-0000 SB3-00-0000	02/22/07

DWG SIZE	DRAWING NUMBER	DWG REV	EPL/DRL/DDS NUMBER	DWG REV	EPL DSH	EPL REV	EO DASH NUMBER	EO REV	PART NUMBER
			MSFC-HDBK-1453		202	-			
			MSFC-HDBK-1674		202	-			
			MSFC-HDBK-2221		203	-			
			MSFC-HDBK-505		202	-			
			MSFC-HDBK-670		202	-			
			MSFC-MNL-1951		209	-			
			MSFC-PROC-1301		202	-			
			MSFC-PROC-1721		202	-			
			MSFC-PROC-1831		202	-			
			MSFC-PROC-1832		202	-			
			MSFC-PROC-404		202	-			
			MSFC-PROC-547		202	-			
			MSFC-QPL-1918		204	-			
			MSFC-RQMT-1282		202	-			
			MSFC-SPEC-1198		202	-			
			MSFC-SPEC-1238		202	-			
			MSFC-SPEC-1443		202	-			
			MSFC-SPEC-164		202	-			
			MSFC-SPEC-1870		202	-			
			MSFC-SPEC-1918		203	-			
			MSFC-SPEC-1919		206	-			
			MSFC-SPEC-2083		202	-			
			MSFC-SPEC-2223		202	-			
			MSFC-SPEC-2489		206	-			
			MSFC-SPEC-2490		205	-			
			MSFC-SPEC-2491		203	-			
			MSFC-SPEC-2492		203	-			
			MSFC-SPEC-2497		211	-			
			MSFC-SPEC-250		202	-			
			MSFC-SPEC-445		202	-			
			MSFC-SPEC-504		202	-			
			MSFC-SPEC-521		202	-			
			MSFC-SPEC-548		202	-			
			MSFC-SPEC-560		202	-			
			MSFC-SPEC-626		202	-			
			MSFC-SPEC-684		202	-			
			MSFC-SPEC-708		202	-			
			MSFC-SPEC-766		202	-			
			MSFC-STD-1249		202	-			
			MSFC-STD-1800		202	-			
			MSFC-STD-246		202	-			
			MSFC-STD-2594		203	-			

PACKAGE NO: 10443R

DWG SIZE	DRAWING NUMBER	DWG REV	EPL/DRL/DDS NUMBER	DWG REV	EPL DSH	EPL REV	EO DASH NUMBER	EO REV	PART NUMBER
			MSFC-STD-2903		202	-			
			MSFC-STD-2904		202	-			
			MSFC-STD-2905		202	-			
			MSFC-STD-2906		202	-			
			MSFC-STD-2907		202	-			
			MSFC-STD-366		202	-			
			MSFC-STD-383		202	-			
			MSFC-STD-486		202	-			
			MSFC-STD-506		203	-			
			MSFC-STD-531		202	-			
			MSFC-STD-557		202	-			
			MSFC-STD-561		203	-			
			MSFC-STD-781		202	-			

SUBMITTED BY ENGINEERING AREA:	BASIC	CHANGE	PARTIAL	COMPLETE	CLOSES	ACTION
EO03		X		X		EO03

PREPARED BY:  
EUGENA GOGGANS  
12/19/06

SUBMITTED BY:

CONCURRENCE:

TRANSMITTAL DATES  
TO RELEASE DESK 02/22/07 10:00  
TO MSFC DOC REP 02/22/07 00:00

REMARKS:

2007 FEB 22 AM 11:22